

Technical Support / Assistance technique / Technischer Support /
 Technische ondersteuning / Supporto tecnico / Asistencia técnica /
 Műszaki támogatás / Technická podpora / Pomoc techniczna /
 Техническая поддержка / Assistència tècnica

| | | | |
|-------------------|----------------|--------------------|------------------|
| Australia | 1300 881 931 | Nederland | 010 713 1882 |
| België / Belgique | 02 401 2395 | New Zealand | 0800 539 26273 |
| Brasil | 14 3235-4003 | Norway | 80017520 |
| Canada | 1 800 268 3447 | Österreich | 0800 677 873 |
| Denmark | 80 250966 | Polska | 22 570 18 00 |
| Deutschland | 0692 222 3654 | Portugal | 800855802 |
| España | 911 146 735 | Russia | 007 495 933 5163 |
| Finland | 0800 9 15697 | Schweiz / Suisse | 044 580 6667 |
| France | 01 7671 0404 | Sweden | 08 5033 6577 |
| Hungary | 06 20 9430 612 | United Kingdom | 0203 364 5390 |
| Ireland | 01 431 1395 | United States | 1 800 535 4242 |
| Italia | 02 3604 7030 | International Toll | +31 53 484 9135 |
| México | 55 15 00 57 00 | | |



Kensington Computer Products Group
 A Division of ACCO Brands
 1500 Fashion Island Blvd
 3rd Floor, San Mateo, CA 94404



ACCO Brands Europe
 A Division of ACCO Brands Europe
 Oxford House, Oxford Road
 Aylesbury, Buckinghamshire
 HP21 8SZ
 United Kingdom

ACCO Brands Canada Inc
 7381 Bramalea Rd
 Mississauga, ON L5S 1C4

ACCO Australia
 Level 2, 8 Lord St
 Botany NSW 2019
 Australia

Importado por ACCO Mexicana S.A. de C.V.
 Circuito de la Industria Norte # 6,
 Corredor Industrial Toluca Lerma,
 Lerma México Cp. 52004
 R.F.C. AME640229-1W3

Acco Brands Chile S.A.
 Avda. San Josemaría
 Escrivá de Balaguer N°5773
 Vitacura, C.P. 7640870
 Santiago, Chile

Importado e Distribuído por:
 TILIBRA PRODUTOS DE PAPELARIA LTDA.
 CNPJ: 44.990.901/0001-43
 Rua Aymorés, 6-9 – Bauru/SP – Brasil
 CEP 17013-900
www.kensington.com.br

Kensington®

Pro Fit™ Wireless Mid-Size Mouse

QUICK START GUIDE

GUIDE DE DEMARRAGE RAPIDE

KURZANLEITUNG

SNELSTARTGIDS

GUIDA RAPIDA

GUÍA RÁPIDA

GYORSKALAUZ

PŘÍRUČKA ZAČÍNÁME

SZYBKI START

КРАТКОЕ РУКОВОДСТВО

ПОЛЬЗОВАТЕЛЯ

MANUAL DE INÍCIO RÁPIDO

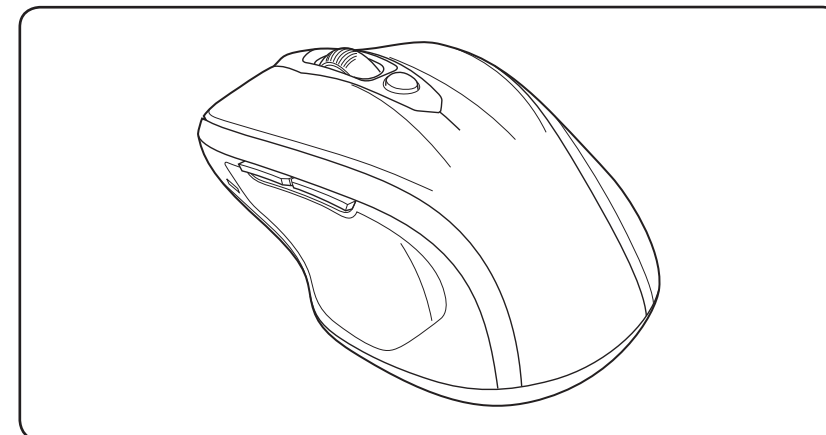

Register Now!
Enregistrer maintenant !
Jetzt registrieren!
Nu registreren
Registrar ahora
Registra adesso

Regisztráljon most!
Zaregistrujte se nyní!
Zarejestruj się!
Зарегистрироваться!
Registe-se agora!

register.kensington.com

Contents / Contenu / Inhalt / Inhoud / Contenido / Contento / Tartalom / Obsah / Spis treści / Содержание / Conteúdo

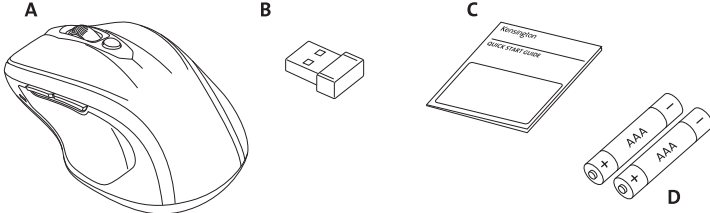

A. Wireless Mouse / Souris sans fil / Kabellose Maus / draadloze muis / Mouse wireless / Ratón inalámbrico / Vezeték nélküli egér / Bezdrátová myš / Mysz bezprzewodowa / Беспроводная мышь / Rato sem fios

B. Wireless USB receiver / Récepteur USB sans fil / Kabelloser USB-Empfänger / Draadloze USB-ontvanger / Ricevitore wireless USB / Receptor USB inalámbrico / USB vezetékek nélküli vevőegység / USB bezdrátový přijímač / Odbiornik bezprzewodowy USB / Беспроводной USB-приемник / Receptor USB sem fios

C. Quick start guide / Guide de démarrage rapide / Kurzanleitung / Snelstartgids / Guida rapida / Guia rápida / Gyorskalauz / Příručka začínáme / Szybki start / Краткое руководство пользователя / Manual de inicio rápido

D. 2 'AAA' batteries / 2 piles AAA / 2 AAA-Batterien / 2 AAA-batterijen / 2 batterie AAA / 2 pilas AAA / 2 AAA akkumulátorok / 2 baterie AAA / 2 baterie AAA / 2 батареи типа AAA / 2 pilhas AAA

Getting Started / Démarrage / Erste Schritte / Aan de slag / Introduzione / Introducción / Az első lépések / Začínáme / Pierwsze kroki / Начало работы / Preparativos

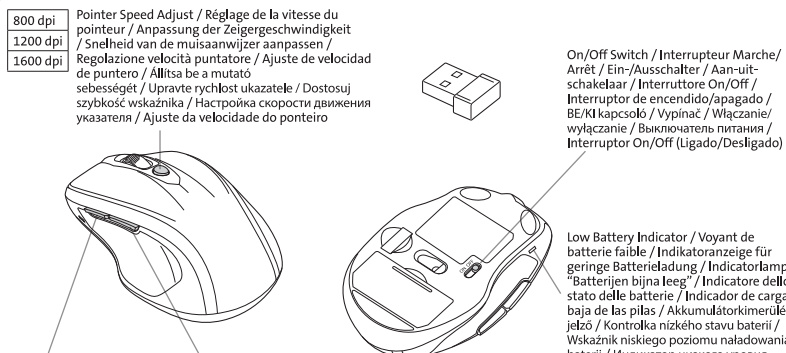

800 dpi / Pointeur Speed Adjust / Réglage de la vitesse du pointeur / Anpassung der Zeigergeschwindigkeit / Snelheid van de muisaanwijzer aanpassen / Regolazione velocità puntatore / Ajuste de velocidad de puntero / Allitsa be a mutató sebességét / Upravte rychlost ukazatele / Dostosuj szybkość wskaźnika / Настройте скорости движения указателя / Ajuste da velocidade do ponteiro

On/Off Switch / Interrupteur Marche/ Arrêt / Ein-/Ausschalter / Aan-uit-schakelaar / Interruttore On/Off / Interruptor de encendido/apagado / ВЕ/КІ карцсола / Вырiнач / Włączanie/wyłączenie / Выключатель питания / Interruptor On/Off (Ligado/Desligado)

Low Battery Indicator / Voyant de batterie faible / Indikatoranzeige für geringe Batterieladung / Indicatorlampje "Batterijen bijna leeg" / Indicatore dello stato delle batterie / Indicador de carga baja de las pilas / Akkumulátorkimerülés-jelző / Kontrolka nízkeho stavu baterii / Wskaźnik niskiego poziomu naładowania baterii / Индикатор низкого уровня заряда батареи / Indicator de baixa bateria

Forward / Suivant / Vor / Vooruit / Avanti / Adelante / Elóre / Dale / Dalej / Вперед / Назад / Avança

Back / Précédent / Zurück / Terug / Indietro / Atrás / Hátra / Zpét / Wstecz / Назад / Retroceder

1

- Install the batteries
 Installer les piles
 Legen Sie die Batterien ein
 De batterijen installeren
 Inserire le batterie
 Instalar las baterías
 Helyezze be az elemeket
 Nainstalujte baterie
 Zainstaluj baterie
 Установите батареи
 Introduza as pilhas

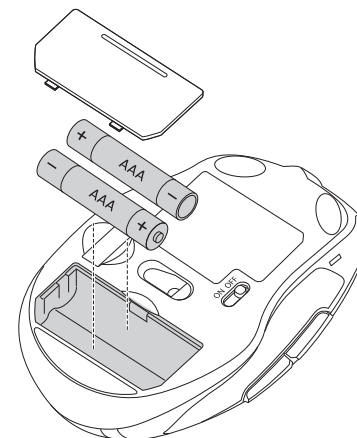

2

- Plug in the receiver
 Brancher le récepteur
 Schließen Sie den Empfänger an
 De ontvanger aansluiten
 Collegare il ricevitore
 Conectar el receptor
 Csatlakoztassa a vevőegységét
 Připojte přijímač do zásuvky
 Podłącz odbiornik
 Подключите приемник
 Ligue o receptor

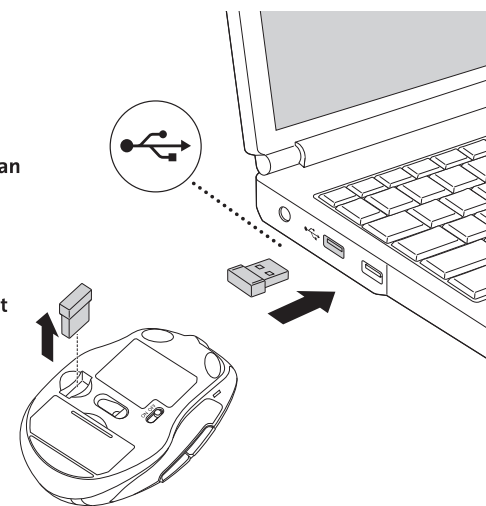

3

Wait for Windows to install

Attendre que Windows procède à l'installation

Warten Sie, bis Windows die Installation abgeschlossen hat

Wachten tot Windows de installatie uitvoert

Attendere l'installazione da parte di Windows

Esperar que acabe la instalación de Windows

Várja meg a Windows telepítését

Vyčkejte na instalaci ve Windows

Poczekaj na zainstalowanie przez system Windows

Дождитесь завершения установки Windows.

Aguarde até que termine a instalação do Windows

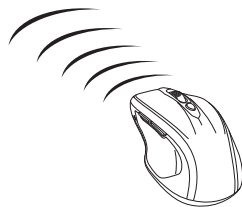
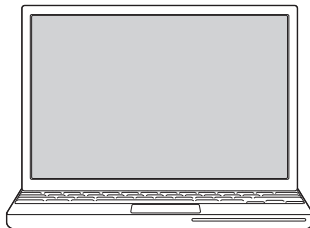

English

Common Troubleshooting Steps

1. Unplug and re-plug the receiver.
2. Install a fresh set of batteries in the mouse.
3. Follow steps below to re-establish a wireless connection.
4. Test the device on another USB port or computer.
5. Some surfaces (including reflective surfaces like glass or mirrors) may “trick” the optical sensor. Use of a mousepad is recommended in these cases.

Web Support

You may find the answer to your problem in the Frequently Asked Questions (FAQ) section of the Support area on the Kensington Website: www.support.kensington.com.

Telephone Support

There is no charge for technical support except long-distance charges where applicable. Please visit www.kensington.com for telephone support hours. In Europe, technical support is available by telephone Monday to Friday 09:00 to 18:00 (Central European time).

When calling support, please call from a phone where you have access to your device, and be ready to provide:

- Your name, address, and telephone number
- Name of the Kensington product
- Make and model of your computer (and operating system)

▲ HEALTH WARNING

Use of a keyboard, mouse, or trackball may be linked to serious injuries or disorders. Recent medical research of occupational injuries has linked normal, seemingly harmless activities as a potential cause of Repetitive Stress Injuries (“RSI”). Many factors may be linked to the occurrence of RSI, including a person’s own medical and physical condition, overall health, and how a person positions and uses his or her body during work and other activities (including use of a keyboard, mouse, or trackball). Some studies suggest that the amount of time a person uses a keyboard, mouse, or trackball may also be a factor. Consult a qualified health professional for any questions or concerns you may have about these risk factors.

When using a keyboard, mouse, or trackball, you may experience occasional discomfort in your hands, arms, shoulders, neck, or other parts of your body. However, if you experience symptoms such as persistent or recurring discomfort, pain, throbbing, aching, tingling, numbness, burning sensation, or stiffness, even if such symptoms occur while you are not working at your computer. **DO NOT IGNORE THESE WARNING SIGNS. PROMPTLY SEE A QUALIFIED HEALTH PROFESSIONAL.** These symptoms can be signs of sometimes permanently disabling RSI disorders of the nerves, muscles, tendons, or other parts of the body.

FEDERAL COMMUNICATIONS COMMISSION RADIO FREQUENCY INTERFERENCE STATEMENT

This device has been tested and found to comply with the limits for a Class B digital device, pursuant to Part 15 of the FCC Rules. These limits are designed to provide reasonable protection against harmful interference in a residential installation. This equipment generates, uses and can radiate radio frequency energy and, if not installed and used in accordance with the instructions, may cause harmful interference to radio communications. However, there is no guarantee that interference will not occur in a particular installation. If this equipment causes harmful interference to radio or television reception, which can be determined by turning the equipment off and on, the user is encouraged to try to correct the interference by one or more of the following measures:

- Reorient or relocate the receiving antenna.
- Increase the separation between the equipment and receiver.
- Connect the equipment into an outlet on a circuit different from that to which the receiver is connected.
- Consult the dealer or an experienced radio/TV technician for help.

MODIFICATIONS: Modifications not expressly approved by Kensington may void the user’s authority to operate the device under FCC regulations and must not be made.

SHIELDED CABLES: In order to meet FCC requirements, all connections to equipment using a Kensington input device should be made using only the shielded cables.

RF TECHNICAL SPECIFICATION

Operating Frequency Range: 2.403GHz to 2.478GHz.

Maximum RF Output Power: 0 dbm

FCC RADIATION EXPOSURE STATEMENT

This equipment complies with FCC radiation exposure limits set forth for an uncontrolled environment. End users must follow the specific operating instructions for satisfying RF exposure compliance. This transmitter must not be co-located or operating in conjunction with any other antenna or transmitter.

FCC DECLARATION OF CONFORMITY COMPLIANCE STATEMENT

This product complies with Part 15 of the FCC rules. Operation is subject to the following two conditions: (1) This device may not cause harmful interference, and (2) This device must accept any interference received, including interference that may cause undesired operation. As defined in Section 2.909 of the FCC Rules, the responsible party for this device is Kensington Computer Product Group, 1500 Fashion Island Blvd, 3rd Floor, San Mateo, CA 94404, USA.

INDUSTRY CANADA CONFORMITY

This device has been tested and found to comply with the limits specified in RSS-210. Operation is subject to the following two conditions: (1) This device may not cause interference, and (2) This device must accept any interference, including interference that may cause undesired operation of the device. This Class [B] digital apparatus complies with Canadian ICES-003.

Obsah je uzamčen

Dokončete, prosím, proces objednávky.

Následně budete mít přístup k celému dokumentu.



Proč je dokument uzamčen? Nahněvat Vás rozhodně nechceme. Jsou k tomu dva hlavní důvody:

- 1) Vytvořit a udržovat obsáhlou databázi návodů stojí nejen spoustu úsilí a času, ale i finanční prostředky. Dělali byste to Vy zadarmo? Ne*. Zakoupením této služby obdržíte úplný návod a podpoříte provoz a rozvoj našich stránek. Třeba se Vám to bude ještě někdy hodit.

**) Možná zpočátku ano. Ale vězte, že dotovat to dlouhodobě nelze. A rozhodně na tom nezbohatneme.*

- 2) Pak jsou tady „roboti“, kteří se přiživují na naší práci a „vysávají“ výsledky našeho úsilí pro svůj prospěch. Tímto krokem se jim to snažíme překazit.

A pokud nemáte zájem, respektujeme to. Urgujte svého prodejce. A když neuspějete, rádi Vás uvidíme!