



Russell Hobbs

A BRITISH ICON SINCE 1952

26422-70

 www.russellhobbs.com

- GB
- DE
- FR
- NL
- IT
- ES
- PT
- DK
- SE
- NO
- FI
- RU
- CZ
- SK
- PL
- HR
- SI
- GR
- HU
- TR
- RO
- BG
- UA
- AE

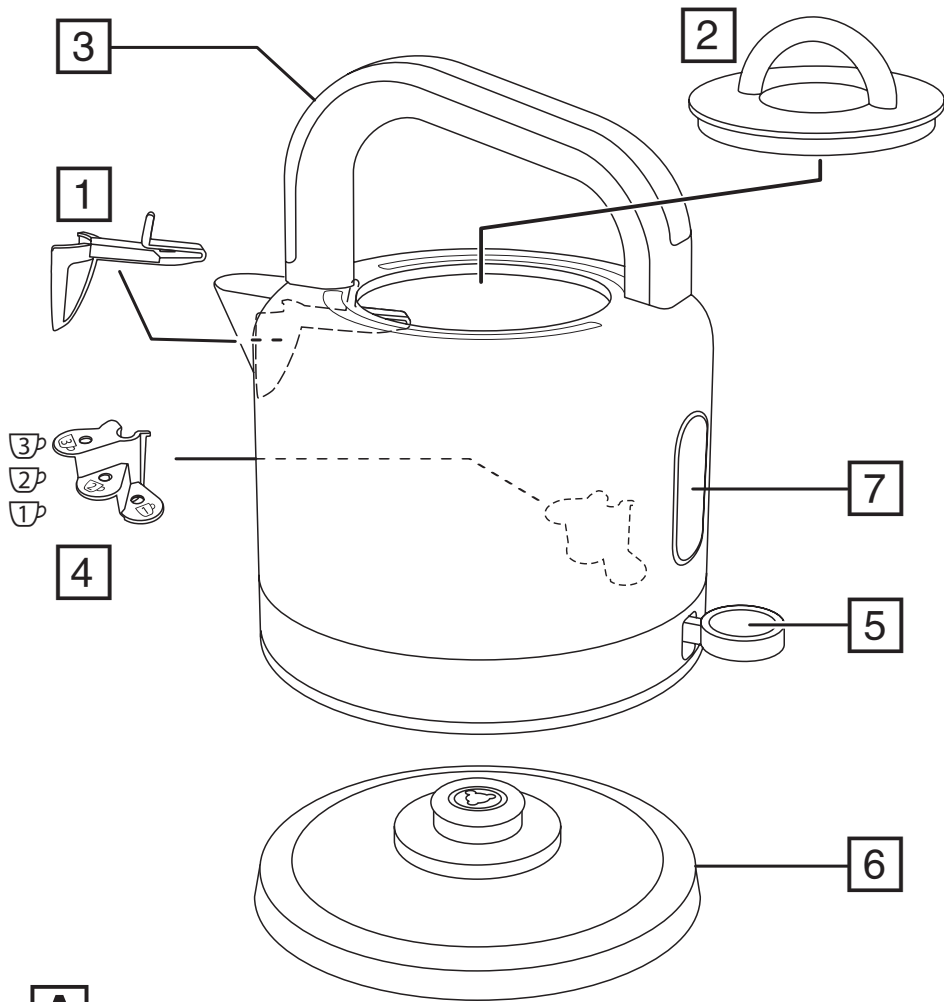

A

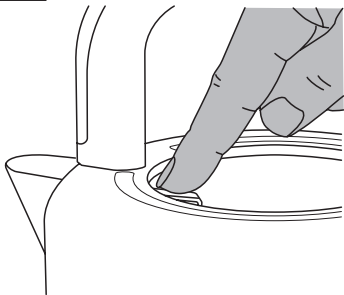

IMPORTANT SAFEGUARDS

Follow basic safety precautions, including:

This appliance can be used by children aged from 8 years and above and persons with reduced physical, sensory or mental capabilities or lack of experience and knowledge if they have been supervised/instructed and understand the hazards involved. Children shall not play with the appliance.

Cleaning and user maintenance shall not be done by children unless they are older than 8 and supervised.

Keep the appliance and cable out of reach of children under 8 years.

 Parts of the appliance will get hot during use.

WARNING: Do not open the lid while the water is boiling.

If you overfill, the kettle may spit boiling water.

Use the kettle only with the stand supplied (and vice versa).

If the cable is damaged, it must be replaced by the manufacturer, its service agent, or someone similarly qualified, to avoid hazard.

Avoid spillage on the stand/connector.

The surface of the heating element is subject to residual heat after use.

CAUTION: Position the lid so that steam is directed away from the handle.

This appliance can be used by persons with reduced physical, sensory or mental capabilities or lack of experience and knowledge if they have been given supervision or instruction concerning use of the appliance in a safe way and understand the hazards involved.

 Do not immerse in any liquid.

This appliance is intended to be used in household and similar applications such as:

- staff kitchen areas in shops, offices and other working environments;
- by clients in hotels, motels and other residential type environments;
- bed and breakfast type environments;
- farm houses.
- Don't use the kettle for any purpose other than heating water.
- Don't operate the appliance if it's damaged or malfunctions.

PARTS

- | | |
|----------------------------|----------------------|
| 1. Filter | 5. Switch |
| 2. Lid | 6. Stand |
| 3. Handle | 7. Water level gauge |
| 4. Rapid boil zones marker | |

Obsah je uzamčen

Dokončete, prosím, proces objednávky.

Následně budete mít přístup k celému dokumentu.



Proč je dokument uzamčen? Nahněvat Vás rozhodně nechceme. Jsou k tomu dva hlavní důvody:

- 1) Vytvořit a udržovat obsáhlou databázi návodů stojí nejen spoustu úsilí a času, ale i finanční prostředky. Dělali byste to Vy zadarmo? Ne*. Zakoupením této služby obdržíte úplný návod a podpoříte provoz a rozvoj našich stránek. Třeba se Vám to bude ještě někdy hodit.

**) Možná zpočátku ano. Ale vězte, že dotovat to dlouhodobě nelze. A rozhodně na tom nezbohatneme.*

- 2) Pak jsou tady „roboti“, kteří se přiživují na naší práci a „vysávají“ výsledky našeho úsilí pro svůj prospěch. Tímto krokem se jim to snažíme překazit.

A pokud nemáte zájem, respektujeme to. Urgujte svého prodejce. A když neuspějete, rádi Vás uvidíme!