

TV Wall Bracket

TV-Wandhalterung

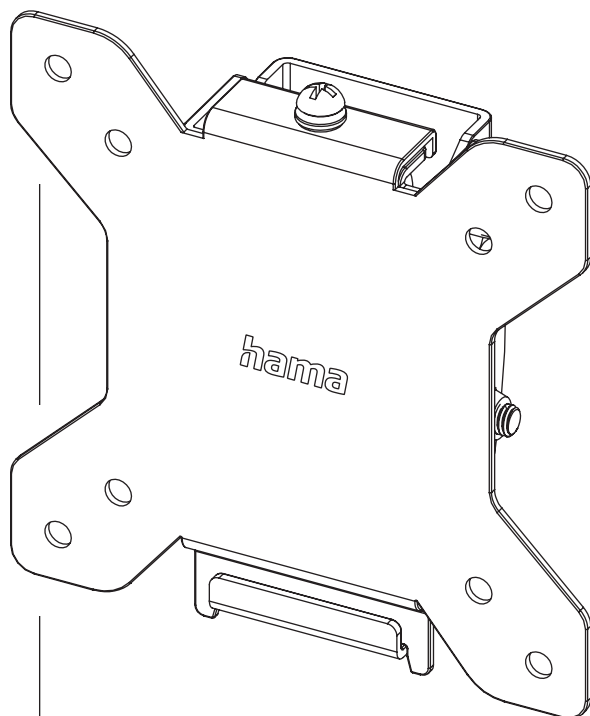

Operating Instructions

Bedienungsanleitung

Mode d'emploi

Instrucciones de uso

Руководство по эксплуатации

Istruzioni per l'uso

Gebruiksaanwijzing

Οδηγίες χρήσης

Instrukcja obsługi

Használati útmutató

Návod k použití

Návod na použitie

Manual de instruções

Kullanma kılavuzu

Manual de utilizare

Bruksanvisning

Käyttöohje

Ръководство за обслужване

GB

D

F

E

RUS

I

NL

GR

PL

H

CZ

SK

P

TR

RO

S

FIN

BG

Required tools



Installation kit

	(A1) 5,5x50 (x2)		(C2) M6x20 (x4)*
	(A2) Ø8x40 (x2)		(D1) M8x12 (x4)*
	(A3) M6 (x2)		(D2) M8x20 (x4)*
	(B1) M6 (x4)		(D3) M8x30 (x4)*
	(B2) Ø8x10 (x4)		(E1) M4x12 (x4)
	(B3) Ø8x20 (x4)*		(E2) M4x20 (x4)
	(B4) Ø8x20 (x4)*		(E3) M4x45 (x4)
	(C1) M6x12 (x4)*		

* not included

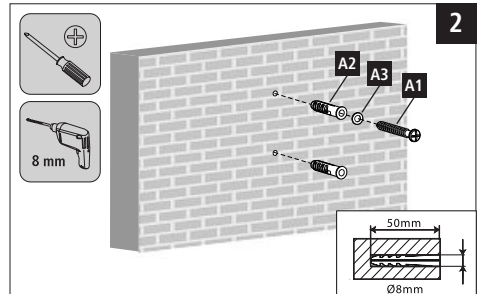
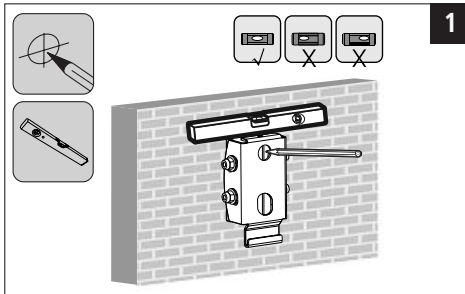

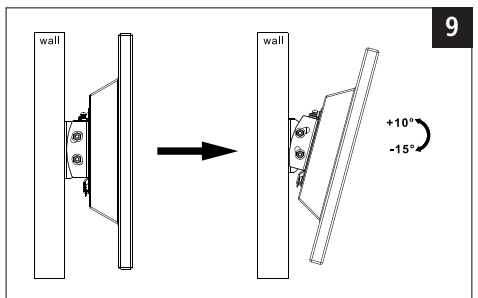
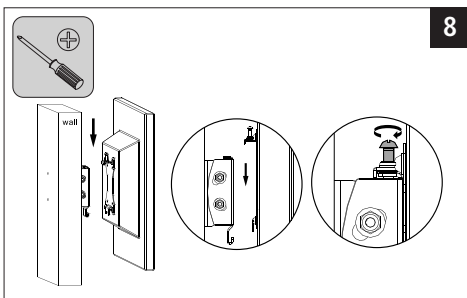
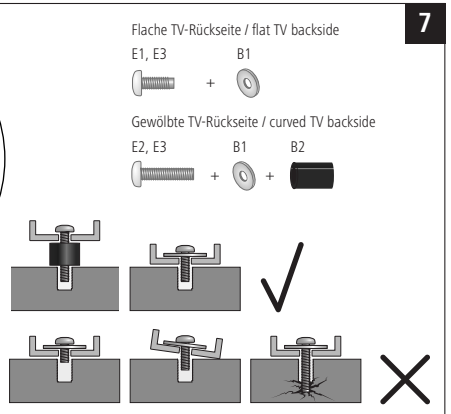
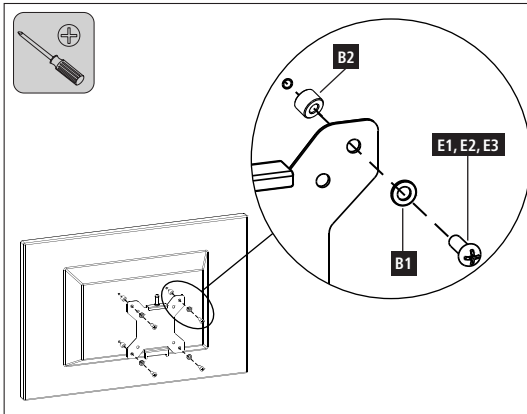
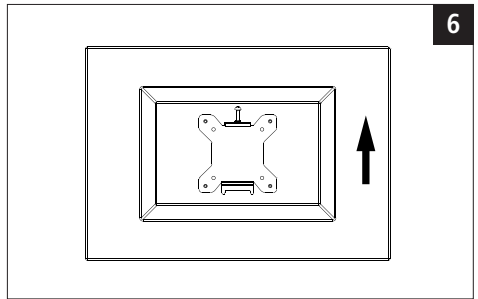
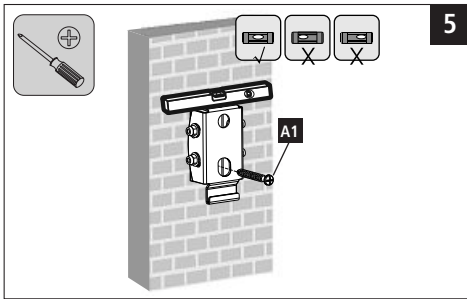
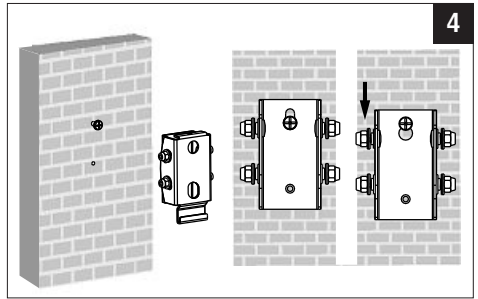
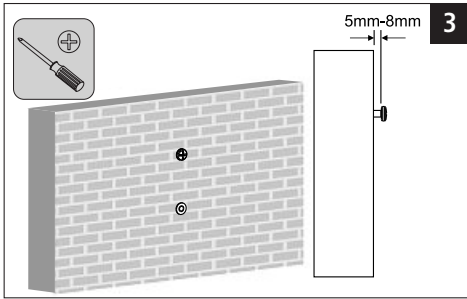

Obsah je uzamčen

Dokončete, prosím, proces objednávky.

Následně budete mít přístup k celému dokumentu.



Proč je dokument uzamčen? Nahněvat Vás rozhodně nechceme. Jsou k tomu dva hlavní důvody:

- 1) Vytvořit a udržovat obsáhlou databázi návodů stojí nejen spoustu úsilí a času, ale i finanční prostředky. Dělali byste to Vy zadarmo? Ne*. Zakoupením této služby obdržíte úplný návod a podpoříte provoz a rozvoj našich stránek. Třeba se Vám to bude ještě někdy hodit.

**) Možná zpočátku ano. Ale vězte, že dotovat to dlouhodobě nelze. A rozhodně na tom nezbohatneme.*

- 2) Pak jsou tady „roboti“, kteří se přiživují na naší práci a „vysávají“ výsledky našeho úsilí pro svůj prospěch. Tímto krokem se jim to snažíme překazit.

A pokud nemáte zájem, respektujeme to. Urgujte svého prodejce. A když neuspějete, rádi Vás uvidíme!