

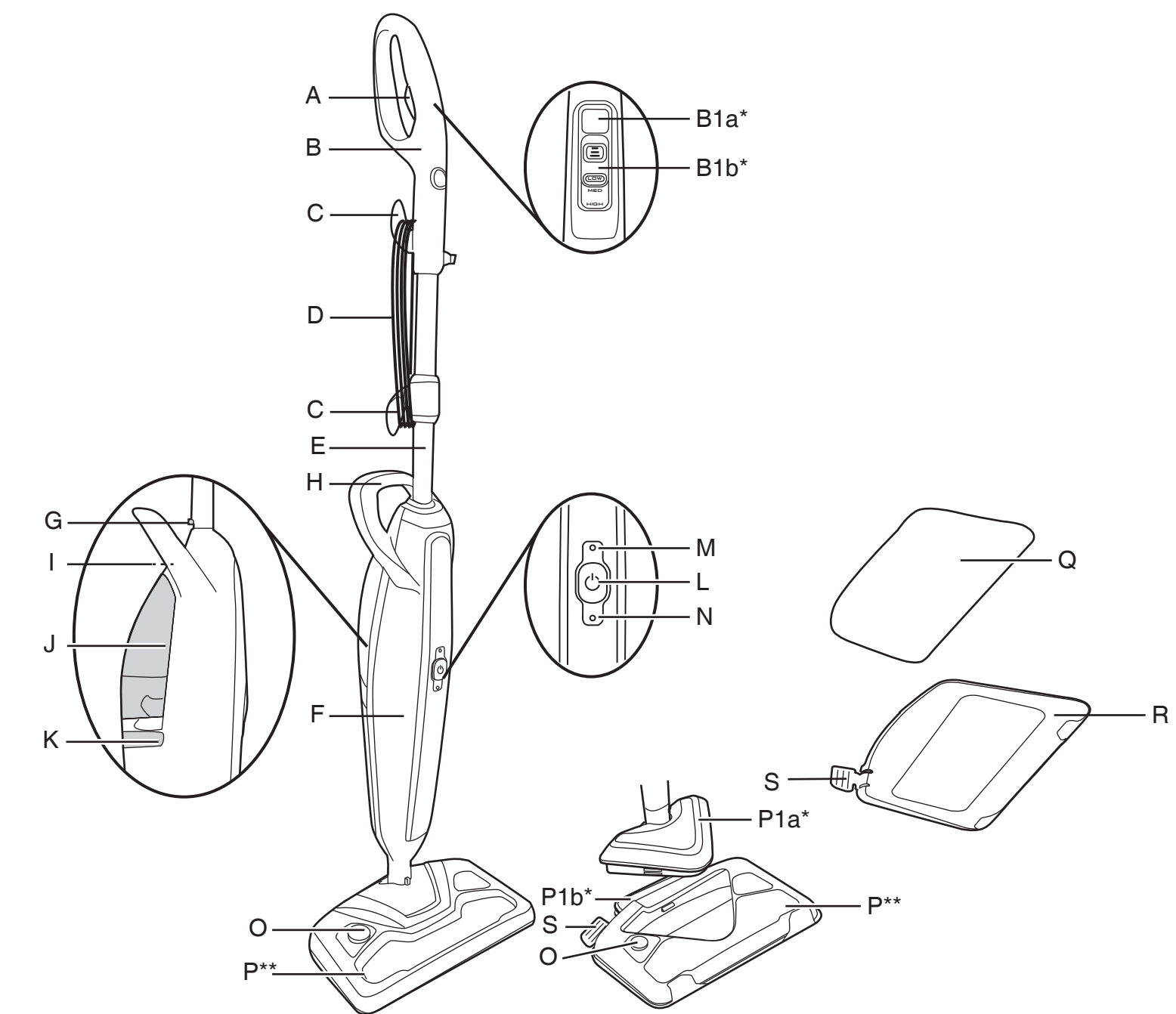

HOOVER



USER MANUAL (GB)P 01
 MANUEL D'UTILISATION (FR)P 04
 BEDIENUNGSANLEITUNG (DE)P 08
 MANUALE ISTRUZIONI (IT)P 11
 GEBRUIKERSHANDLEIDING (NL)P 15
 MANUAL DE INSTRUÇÕES (PT)P 18
 MANUAL DE INSTRUCCIONES (ES)P 22
 BRUGERVEJLEDNING (DK)P 25
 BRUKSANVISNING (NO)P 29
 INSTRUKTIONSMANUAL (SE)P 32
 KÄYTTÖOHJE (FI)P 36
 ΟΔΗΓΙΕΣ ΧΡΗΣΕΩΣ (GR)P 39
 РУКОВОДСТВО ПОЛЬЗОВАТЕЛЯ (RU)P 43
 INSTRUKCJA OBSŁUGI (PL)P 46
 NÁVOD K OBSLUZE (CZ)P 50
 NAVODILA ZA UPORABO (SI)P 53
 KULLANIM KILAVUZU (TR)P 57



*Certain Models Only **Nozzle design may vary according to models

PRINTED IN P.R.C.
48016555



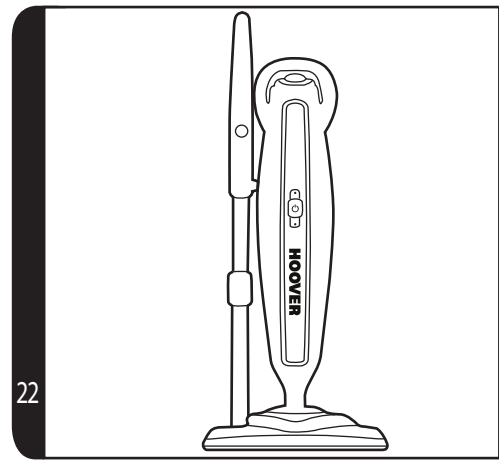
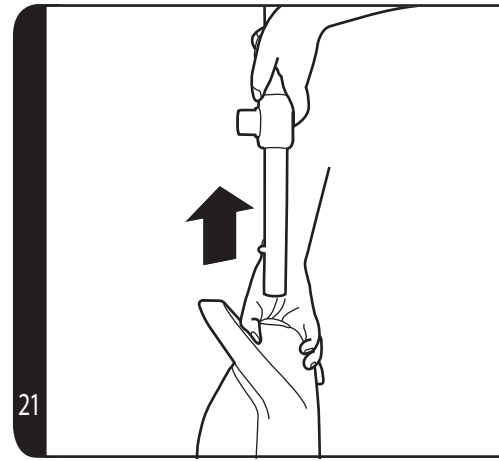
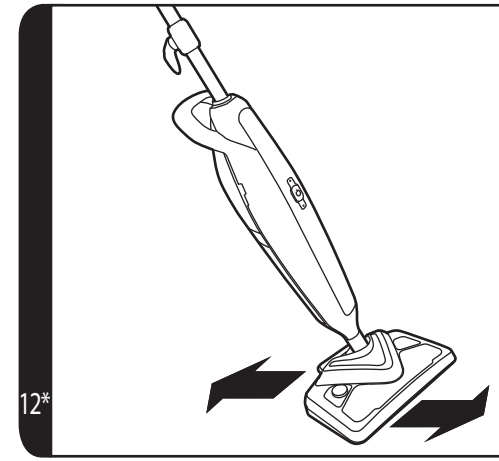
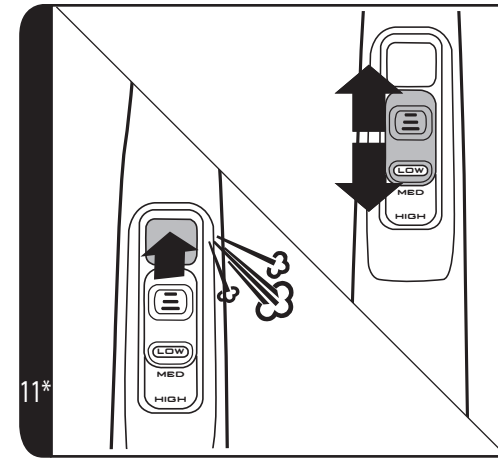
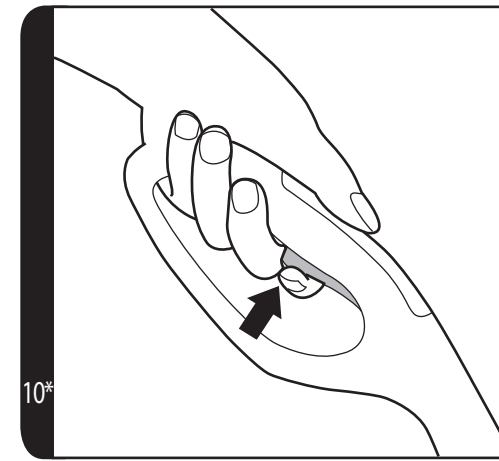
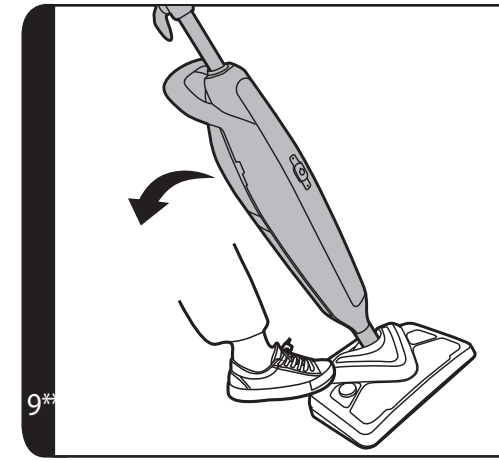
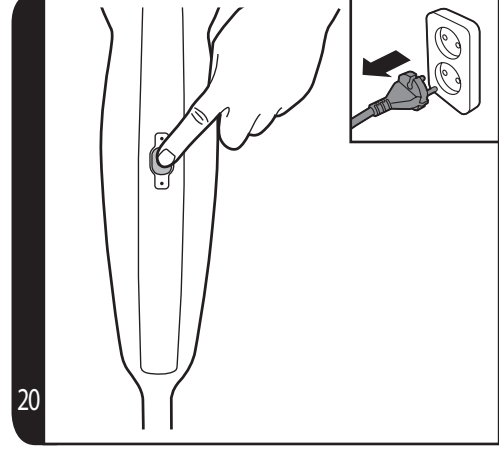
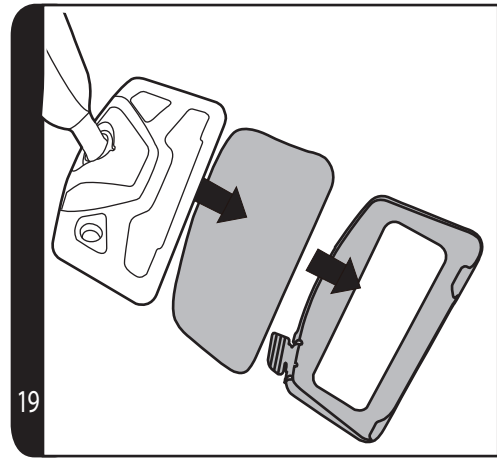
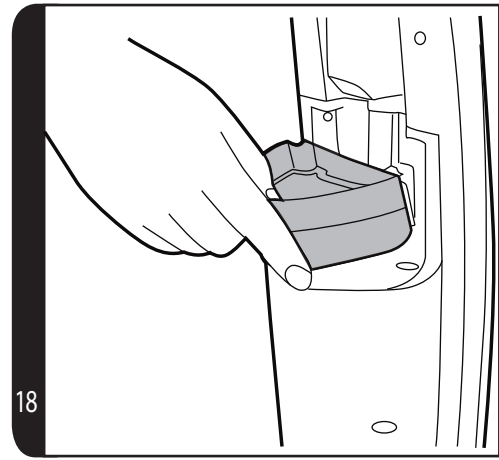
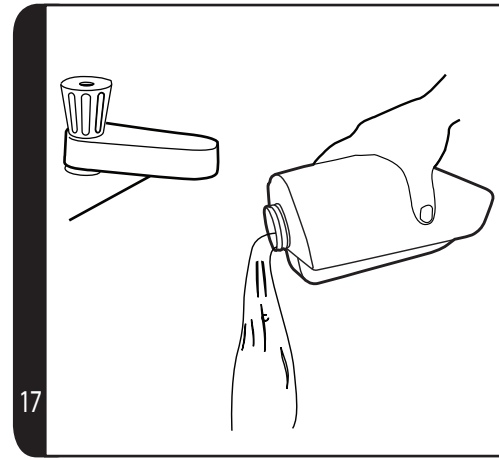
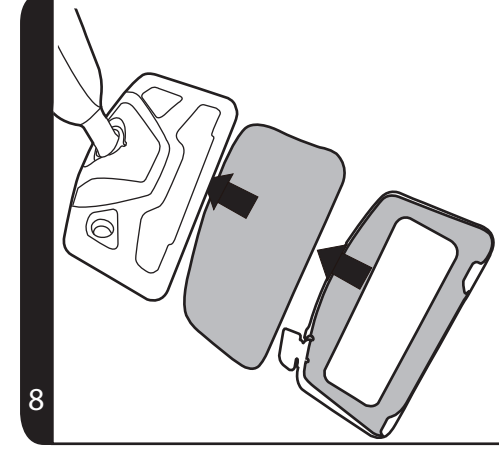
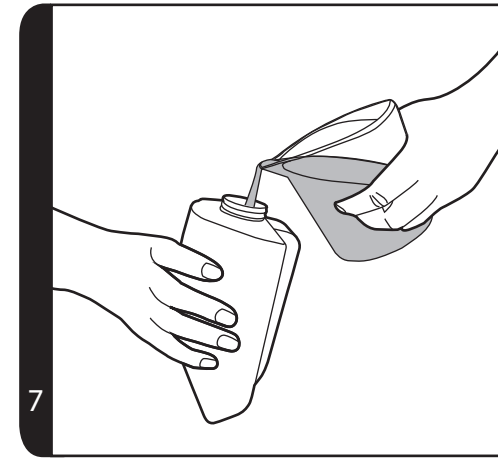
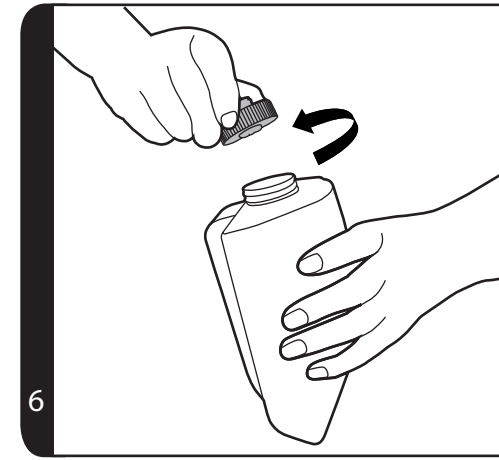
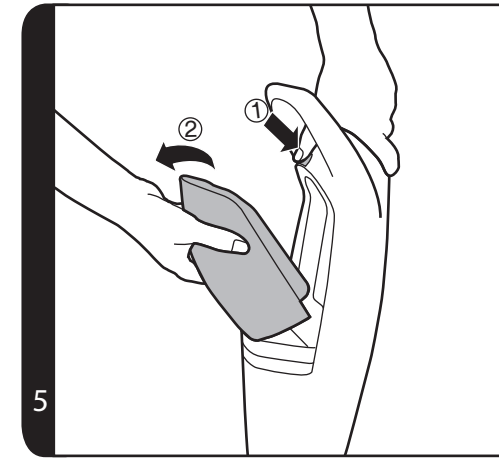
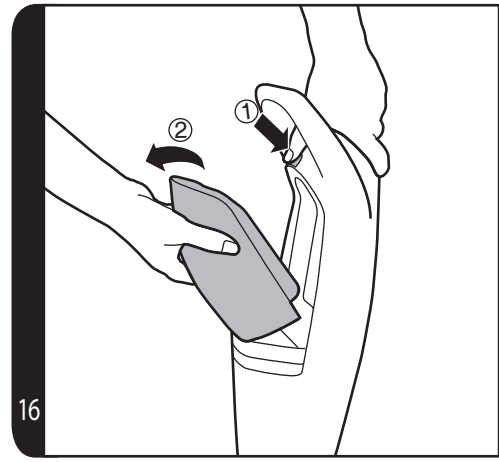
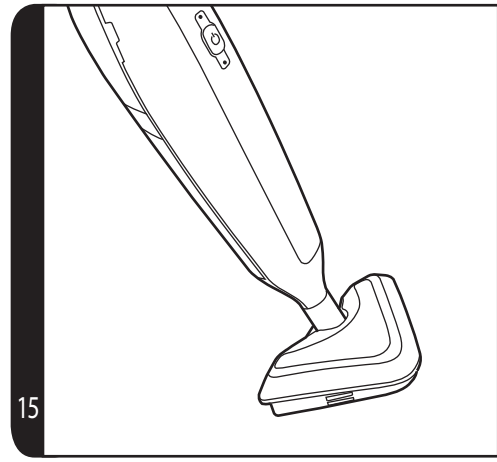
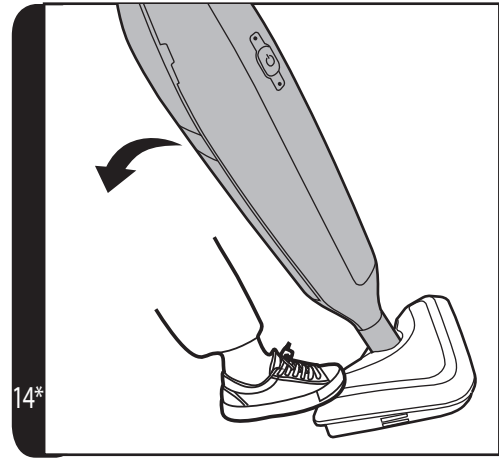
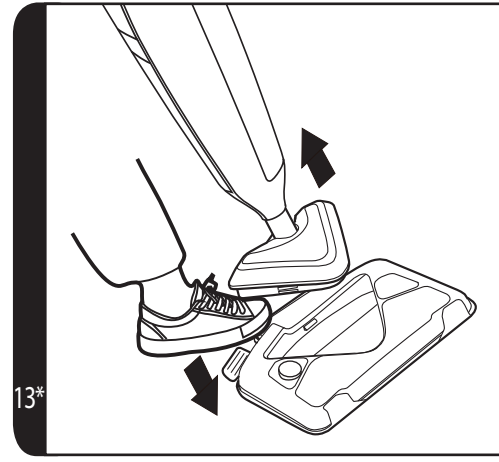
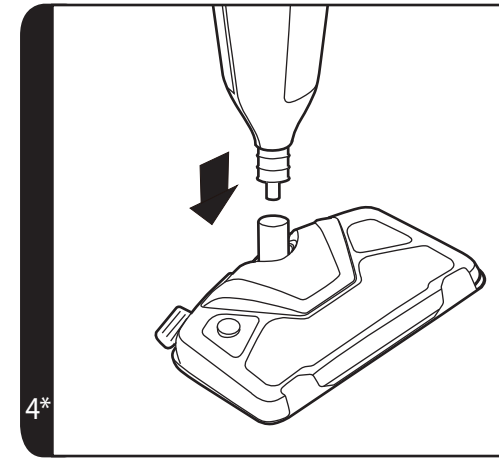
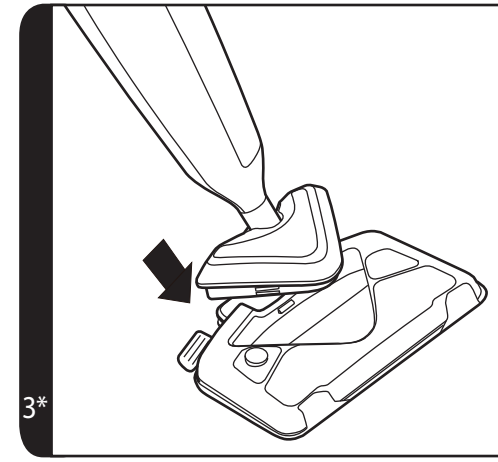
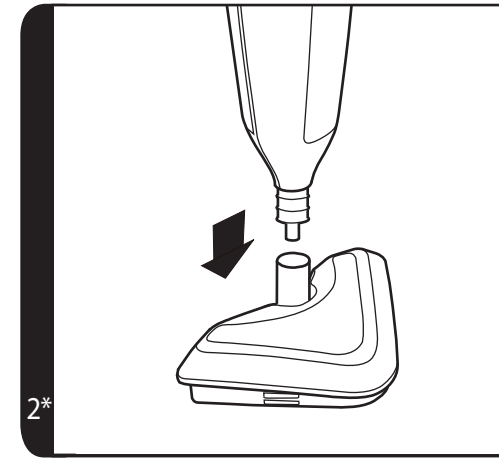
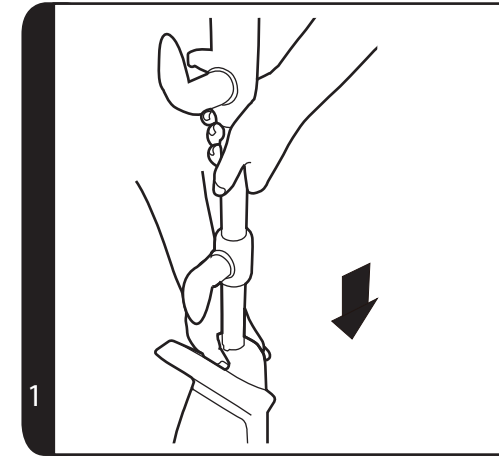

*Certain Models Only





INSTRUCTIONS FOR SAFE USE

This appliance should only be used for domestic cleaning, as described in this user guide. Please ensure that this guide is fully understood before operating the appliance.

Do not leave the appliance plugged in. Always switch off and remove the plug from the socket after use, or before cleaning the appliance or any maintenance task.

This appliance can be used by persons with reduced physical, sensory or mental capabilities or lack of experience and knowledge if they have been given supervision or instruction concerning use of the appliance in a safe way and understand the hazards involved. Children shall not play with the appliance.

Keep the appliance out of reach of children when it is energized or cooling down.

The appliance is not to be used if it has been dropped, if there are visible signs of damage or if it is leaking.

If the power cord is damaged stop using the appliance immediately. To avoid a safety hazard, an authorised Hoover service engineer must replace the power cord.

This appliance must be earthed.

The appliance shall not be left unattended while it is connected to the supply mains.

Do not use your appliance out of doors.

Use only attachments, consumables or spares recommended or supplied by Hoover.

Do not use the appliance to clean or direct steam towards animals, people or plants.

Liquid or steam must not be directed towards equipment containing electrical components, such as the interior of ovens.

The filling aperture must not be opened during use.

Unplug the cleaner and switch off before filling the water container. Do not over-fill the container. Replace the filling cap.

 Danger of Scalding.

 Surfaces are liable to get very hot during use. Avoid contact with steam.

Do not stand on or wrap the cord around arms or legs when using your appliance.

Do not position the appliance above you when cleaning the stairs.

When using the cleaning tools ensure to always steady the appliance with your other hand. This will ensure that the appliance does not fall while in use.

Do not handle the plug or appliance with wet hands.

Do not run over the power cord when using your appliance or remove the plug by pulling on the power cord.

Do not continue to use your appliance if it appears faulty.

Hoover service: To ensure the continued safe and efficient operation of this appliance we recommend that any servicing or repairs are only carried out by an authorised Hoover service engineer.

Do not immerse the appliance in water or other liquids.

Do not use detergents or liquids other than water inside the appliance.

For UK and Ireland only: This appliance has a 13 amp mains plug. If you need to change the fuse in the mains plug, use a 13amp ASTA (BS1362) fuse.

The Environment

The symbol on this appliance indicates that this appliance may not be treated as household waste. Instead it must be handed over to the applicable collection point for the recycling of electrical and electronic equipment. Disposal must be carried out in accordance with local environmental regulations for waste disposal. For more detailed information about treatment, recovery and recycling of this appliance, please contact your local city office, your household and waste disposal service or the shop where you purchased the appliance.



 This appliance complies with the European Directives 2006/95/EC, 2004/108/EC and 2011/65/EU.

HOOVER Limited, Pentrebach, Merthyr Tydfil, Mid Glamorgan, CF48 4TU, UK

Obsah je uzamčen

Dokončete, prosím, proces objednávky.

Následně budete mít přístup k celému dokumentu.



Proč je dokument uzamčen? Nahněvat Vás rozhodně nechceme. Jsou k tomu dva hlavní důvody:

- 1) Vytvořit a udržovat obsáhlou databázi návodů stojí nejen spoustu úsilí a času, ale i finanční prostředky. Dělali byste to Vy zadarmo? Ne*. Zakoupením této služby obdržíte úplný návod a podpoříte provoz a rozvoj našich stránek. Třeba se Vám to bude ještě někdy hodit.

**) Možná zpočátku ano. Ale vězte, že dotovat to dlouhodobě nelze. A rozhodně na tom nezbohatneme.*

- 2) Pak jsou tady „roboti“, kteří se přiživují na naší práci a „vysávají“ výsledky našeho úsilí pro svůj prospěch. Tímto krokem se jim to snažíme překazit.

A pokud nemáte zájem, respektujeme to. Urgujte svého prodejce. A když neuspějete, rádi Vás uvidíme!