

VISIT OUR WEBSITE TO:



Get usage advice, brochures, trouble shooter, service information: www.electrolux.com



Register your product for better service: www.electrolux.com/productregistration



Buy Consumables & Accessories for your appliance: www.electrolux.com/shop



Electrolux

PURED9 Canister vacuum cleaner



CONSUMABLES & ACCESSORIES

www.electrolux.com/shop

Silent Parketto
Ref: ZE115
Part nr: 9001677922



Turbo Brush
Ref: ZE119
Part nr: 9001678003



Delicate Care
Ref: KIT11
Part nr: 9001679597



Clean & Tidy
Ref: KIT12
Part nr: 9001679605



Animal Care
Ref: KIT13
Part nr: 9001679613



s-bag® Ultra Long Performance
Ref: E210S
Part nr: 9001684613

s-bag® Anti-allergy
Ref: E206S
Part nr: 9001684605

s-bag® Anti-odour
Ref: E203S
Part nr: 9001684597

s-bag® Classic Long Performance
Ref: E201S
Part nr: 9001684589

2 Motor filters
Ref: EF54
Part nr: 9000843053

PURED9 Starter Kit
Ref: ESKD9
Part nr: 9001684795



Crispy Bamboo
Ref: ESBA
Part nr: 9001677773

Brown Sugar & Fig
Ref: ESFI
Part nr: 9001677781

Tropical Breeze
Ref: ESCO
Part nr: 9001677799

Citrus Burst
Ref: ESMIA
Part nr: 9001677807

Evening Rose
Ref: ESRO
Part nr: 9001677765

PureD9 filter
Ref: EF151
Part nr: 9001683912

Animal Care filter
Ref: KIT13
Part nr: 9001679613

CUSTOMER CARE AND SERVICE

When contacting Service, ensure that you have the following data available:

- Model Number
- PNC number
- Serial number

The information can be found on the rating plate.

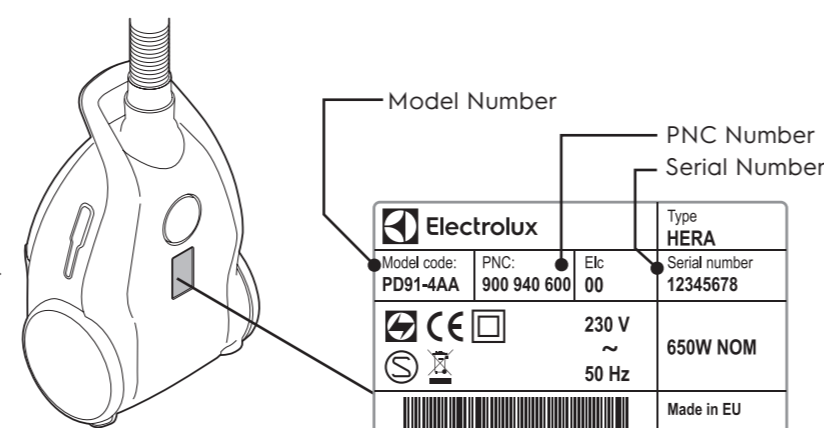

electrolux.com/shop



www.electrolux.com

Electrolux Appliances AB
S:t Göransgatan 14:3
S-105 45 Stockholm
Sweden

GB INSTRUCTION BOOK	4	GR ΕΓΧΕΙΡΙΔΙΟ ΟΔΗΓΙΩΝ	34	RO MANUAL DE INSTRUCȚIUNI	64
FR MODE D'EMPLOI	7	HR KNJIŽICA S UPUTAMA	37	RU ИНСТРУКЦИЯ	67
AR دليل المستخدم	10	HU HASZNÁLATI ÚTMUTATÓ	40	SK NÁVOD NA POUŽITIE	70
BG БРОШУРА С ИНСТРУКЦИИ	13	IT ISTRUZIONI	43	SL NAVODILA	73
CZ NÁVOD K POUŽITÍ	16	LT INSTRUKCIJŲ KNYGA	46	SR UPUTSTVO	76
DE GEBRAUCHSANWEISUNG	19	LV LIETOŠANAS INSTRUKCIJA	49	SV BRUKSANVISNING	79
DK VEJLEDNING	22	NL INSTRUCTIE BOEK	52	TR EL KİTABI	82
EE KASUTUSJUHEND	25	NO BRUKSANVISNING	55	UA ПОСІБНИК КОРИСТУВАЧА	85
ES LIBRO DE INSTRUCCIONES	28	PL INSTRUKCJA OBSŁUGI	58		
FI OHJEKIRJA	31	PT LIVRO DE INSTRUÇÕES	61		

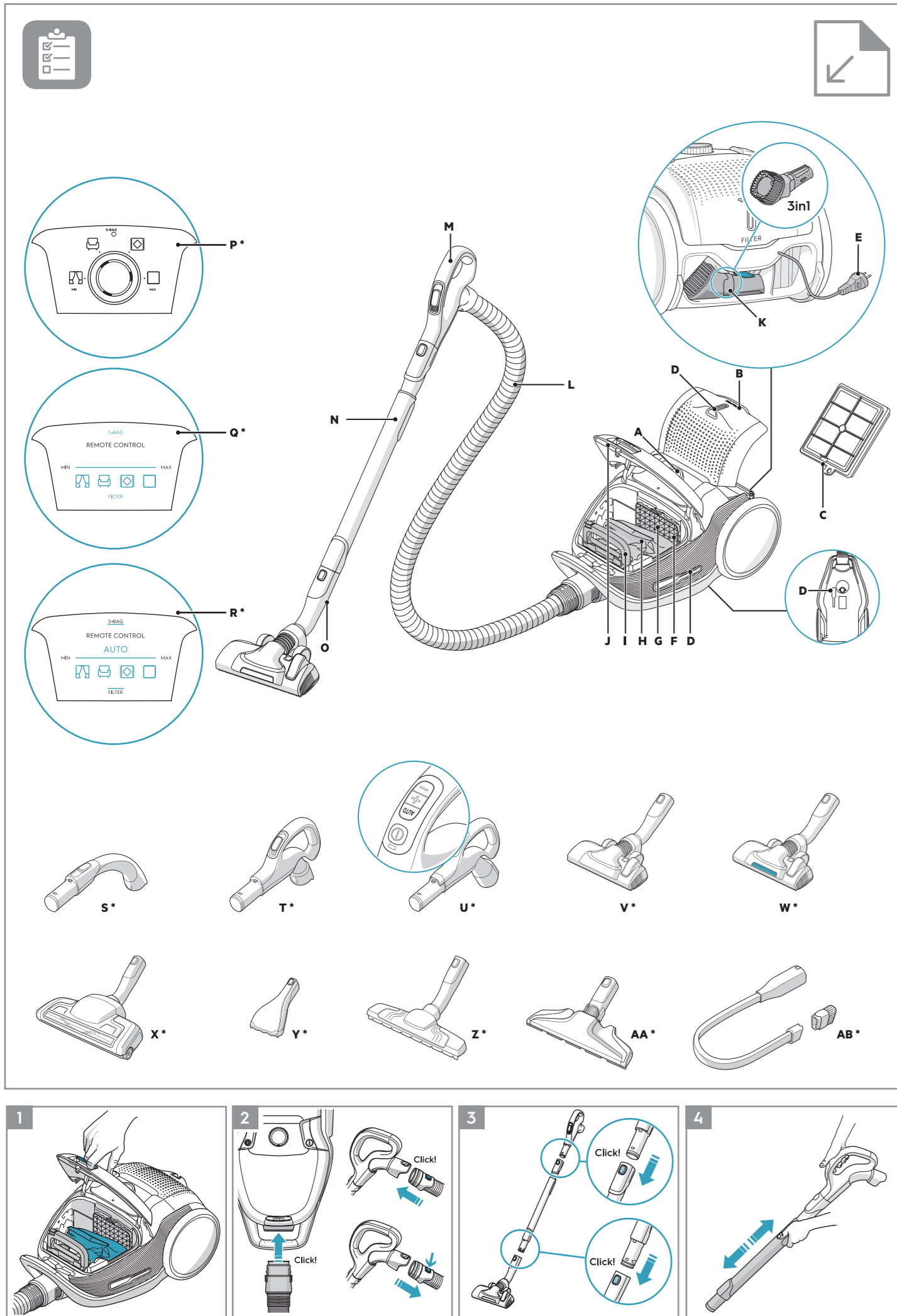

GB
FR
AR
BG
CZ
DE
DK
EE
ES
FI
GR
HR
HU
IT
LT
LV
NL
NO
PL
PT
RO
RU
SE
SK
SL
SR
TR
UA

ENGLISH
Thank you for choosing Electrolux PURE D9 vacuum cleaner. Always use original accessories and spare parts to get the best results. This product is designed with the environment in mind. All plastic parts are marked for recycling purposes.

BEFORE STARTING
• Read this manual carefully.
• Check that all parts described are included.
• Pay special attention to the safety precautions!

DESCRIPTION OF PURE D9 VACUUM CLEANER

A. Display (see versions later)	Q. Display for models with remote control*
B. Exhaust filter lid	R. Display for models with remote control and AUTO function*
C. Exhaust filter	S. AeroPro Classic handle*
D. Parking slots	T. AeroPro Ergo handle*
E. Power cord	U. AeroPro Remote Control handle*
F. Motor filter	V. AeroPro FlowMotion nozzle*
G. Motor filter holder	W. AeroPro PureVision nozzle (with front lights)*
H. S-bag	X. AeroPro Turbo nozzle*
I. S-bag holder	Y. AeroPro Mini Turbo nozzle*
J. Dust compartment cover	Z. ParkettoPro nozzle*
K. AeroPro 3in1 tool	AA. AeroPro FlexProPlus nozzle*
L. AeroPro hose	AB. AeroPro Long crevice nozzle*
M. AeroPro handle (see versions later)	
N. AeroPro telescopic tube	
O. Parking clip	
P. Display for models with rotary knob manual control*	* Certain models only

HOW TO USE THE VACUUM CLEANER

- 1 Open the dust compartment cover by pulling the S-BAG button. Check that the dust bag (s-bag) is in place.
- 2 Insert the hose into the cleaner (to remove it, press the lock buttons and pull). Insert the hose into the hose handle until the lock button clicks (to release it, press the lock button and pull).
- 3 Attach the telescopic tube to the nozzle. Attach the telescopic tube to the hose handle (to remove it, press the lock button and pull).
- 4 Adjust the telescopic tube by holding the lock with one hand and pulling the handle with the other hand.

START/STOP THE VACUUM CLEANER AND ADJUST SUCTION POWER

- 5 Pull out the power cord and plug it into the mains. Press the ON/OFF button to turn the cleaner on/off. Indicators light up, MIN/MAX indicator lights up from left to right and back (auto function models). * Models with remote control can also be operated by the ON/OFF button on the handle.*
- 6 Adjust suction power (manual control models): Turn the rotary knob on the cleaner or use the air valve on the handle.*
- 7 Adjust suction power (remote control models): Press +/- button on the handle. MIN/MAX and symbols indicators on display will show level of power.*
- 8 Adjust suction power (remote control models with AUTO): The cleaner starts in AUTO mode (automatic power regulation). AUTO indicator is illuminated on the display and MIN/MAX indicator pulses. To regulate power manually press +/- button on handle. Press AUTO button to return to auto-function.*
- 9 After cleaning, push the REWIND button to rewind the cable.

PARKING POSITIONS

- 10 Use parking position on the side (A) or underneath (C) to carry and store the cleaner. At the back (B) when you pause (save your back).

REPLACING THE DUSTBAG, S-BAG*

- 11 Replace the s-bag when
- **P* Models with rotary knob:** S-BAG indicator lights up in red
- **Q* Models with remote control:** S-BAG symbol lights up red.
- **R* Models with remote control and AUTO:** S-BAG indicator lights up in red (green light: bag is OK, yellow light: soon time to replace bag).
NB: Always change the s-bag when S-BAG indicator is illuminated or has red light even if the s-bag is not full (it may be blocked) and after

using carpet cleaning powder. For best possible performance, use the Ultra Long Performance bag which is especially developed for your cleaner. Other synthetic s-bags can also be used. Do not use paper dust bags! www.s-bag.com

- 12 Pull the S-BAG button to open the dust compartment. The handle of the s-bag holder goes up. Pull the handle to remove the s-bag with holder. Do not press the release button.
- 13 Hold the s-bag with holder over a dust bin. Press the button to release the s-bag. Insert a new s-bag to the holder by inserting the cardboard at the back of the holder.
- 14 Insert the s-bag with holder by pushing it straight down in its tracks. Make sure the s-bag is not stuck under the holder. Close the lid. If the s-bag is not properly placed or is missing, the lid will not close.

REPLACING THE FILTERS

- 15 Replace/clean** the filter when (**washable filter only)
- **P* Models with rotary knob:** you have changed the s-bag 5 times
- **Q* Models with remote control:** FILTER symbol lights up in red
- **R* Models with remote control and AUTO:** filter indicator lights up in red. Green light indicates that the filter is ok. It lights up briefly when you start the vacuum cleaner.
- 16 Pull the FILTER button to open the filter lid. Use original s-filters. Remove the filter and check the reference on the frame to define type. Replace with a new filter or clean it**. Rinse the inside (dirty side) in lukewarm tap water. Tap the filter frame to remove the water. Repeat the process four times. (**washable filter only)

VACUUMING WITH THE UNIVERSAL NOZZLE (V*, W*)

- 17 After replacing the filter, close the filter lid until it is clicked back into place. If the filter lid comes off, position the hinges at the bottom and push the filter lid until it is clicked back into place.
- 18 Replace the motor filter when dirty or after every 5th s-bag. Push the filter holder down and pull it out. Exchange the filter and close the lid.

NB: Do not use cleaning agents. Avoid touching the filter surface. Let the filter dry completely (min. 24 h in room temperature) before putting back! Change the washable filter at least once a year or when it is very dirty or damaged. Do not remove the L-shaped foam under the filter.

CLEANING THE UNIVERSAL NOZZLE (V*, W)**

- 19 Change nozzle setting with the pedal. Icon illustrates recommended floor type.
- 20 PureVision nozzle*: Move the nozzle forward. The front light turns on automatically after a few seconds. When the nozzle is not used, the light turns off automatically after a few seconds.

CLEANING THE TURBO NOZZLE (X*)

- 21 Disconnect the nozzle from the tube. Clean with the hose handle.
- 22 Disconnect the nozzle from the tube and remove entangled threads etc by snipping them away with scissors. Use the hose handle to clean the nozzle.*

3IN1 ACCESSORY TOOL

- 23 Pull the textile tab to take out 3in1 tool. The tool has 3 functions, see pictures on next page.
- 24 After usage, put it back in its place.

REPLACING THE FILTERS

- 15 Replace/clean** the filter when (**washable filter only)
- **P* Models with rotary knob:** you have changed the s-bag 5 times
- **Q* Models with remote control:** FILTER symbol lights up in red
- **R* Models with remote control and AUTO:** filter indicator lights up in red. Green light indicates that the filter is ok. It lights up briefly when you start the vacuum cleaner.
- 16 Pull the FILTER button to open the filter lid. Use original s-filters. Remove the filter and check the reference on the frame to define type. Replace with a new filter or clean it**. Rinse the inside (dirty side) in lukewarm tap water. Tap the filter frame to remove the water. Repeat the process four times. (**washable filter only)

NB: Do not use cleaning agents. Avoid touching the filter surface. Let the filter dry completely (min. 24 h in room temperature) before putting back! Change the washable filter at least once a year or when it is very dirty or damaged. Do not remove the L-shaped foam under the filter.

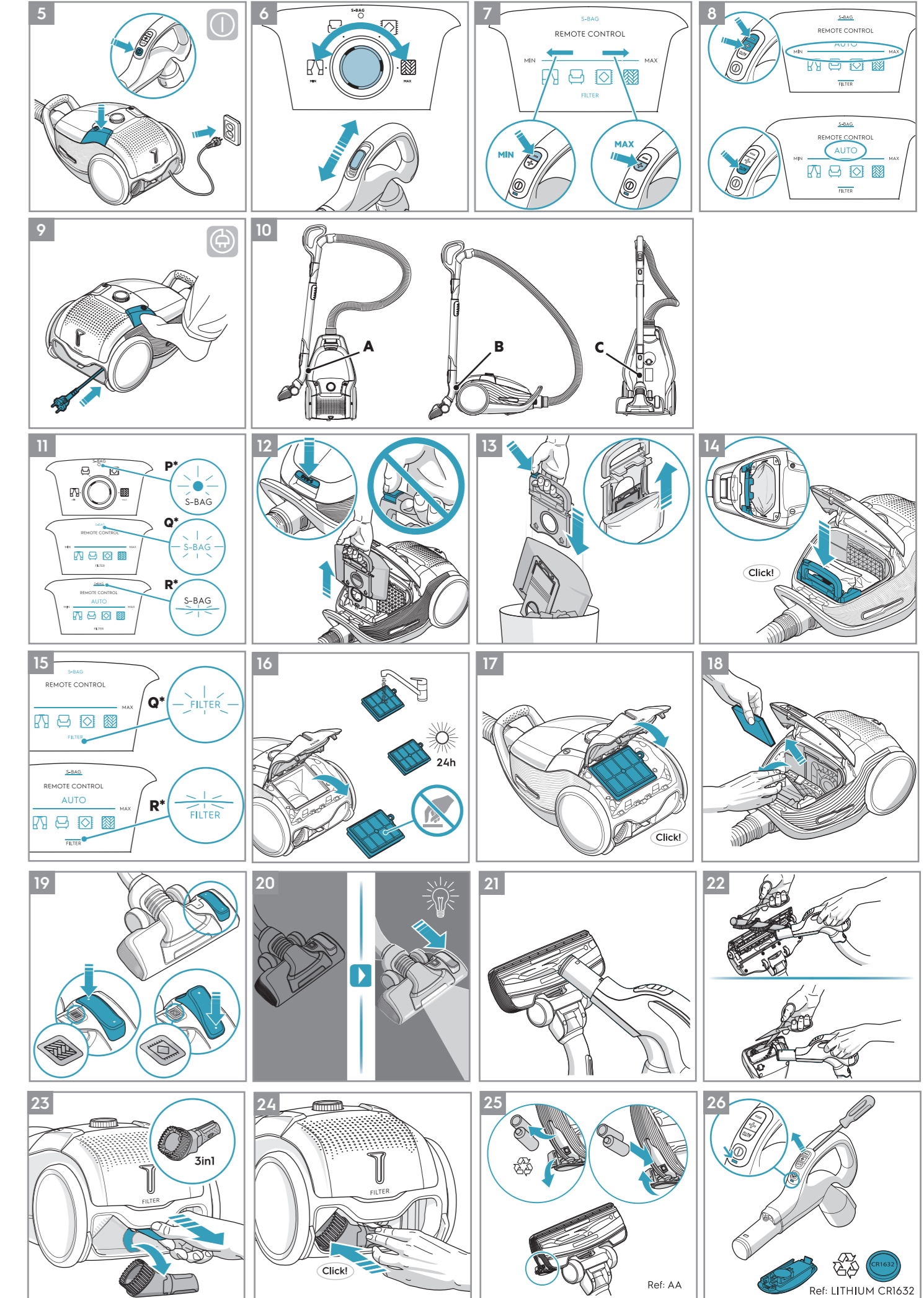





CHANGING THE BATTERIES*

- 25** Nozzle with front lights*: Change batteries when front lights start blinking fast. Use 2 AA batteries.
- 26** Handle with remote control*: Change battery when light indicator turns red or is not responding when pressing any button. Use only batteries type LITHIUM CR1632.
- NB: Remove the batteries from the product before scrapping. Follow your country's rules for collection of batteries and electrical products.

Enjoy a great cleaning experience with PURED9!

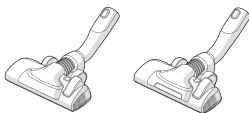
Electrolux reserves the right to change products, information and specifications without notice.

TIPS ON HOW TO GET THE BEST RESULTS

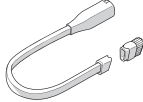
NOZZLE/ACCESSORY	USE FOR:	NOZZLE/ACCESSORY	USE FOR:
K. 3in1 accessory tool* 	3 tools in 1: 1. Dusting tool for hard surfaces (bookshelves, skirting boards etc). 2. Upholstery tool for textiles (curtains, upholstery etc). 3. Crevice tool for narrow spaces (behind radiators etc).	V. FlowMotion nozzle* W. PureVision nozzle (with front lights)* 	Universal nozzle: - For all floor types, secures best dust pick up on both carpets and hard floors. - Change nozzle setting with the pedal. Icon will show recommended floor type. - Front light helps to detect dust and dirt in dark spaces (under furniture etc). <i>PureVision only</i>
X. Turbo nozzle* 	Carpet nozzle: - Brushes and vacuums at the same time (best pick up of hair, fibres etc). - Brush roller is driven by the airflow of the vacuum cleaner. - Not suitable for carpets with very deep piles and long fringes, anti-slip carpets like door mats or water resistant carpets. Use universal nozzle instead.	Y. Mini Turbo nozzle* 	Upholstery nozzle: - Brushes and vacuums at the same time (best pick up of hair, fibres etc). - For textile furniture, car seats, mattresses etc. - Brush roller is driven by the airflow of the vacuum cleaner. - Not suitable for carpets with very deep pile and long fringes as it can get stuck in the rotating brush roll.
Z. ParkettoPro nozzle* 	Hard floor nozzle: - For gentle cleaning of hard floor (parquet, wooden floor, tiles etc). - Best dust pick up on hard floor with crevice.	AA. FlexProPlus nozzle* 	Hardfloor nozzle: - For reach under/between furniture, corners and other obstacles. - Can easily turn 180 degrees for direct access to narrow spaces.
AB. Long crevice nozzle* 	Extra long tool: - For areas hard to reach (top of shelves etc). - For narrow spaces (behind radiators, under car seats etc).		

Models with manual power regulation
 – follow graphics on cleaner for optimal performance.

Models with AUTO-function automatically adjust the suction power
 in order to give an optimal cleaning performance and comfort on every surface. For manual regulation, follow graphics for optimal performance.

TROUBLESHOOTING

PROBLEM	SOLUTION
The vacuum cleaner does not start	<ul style="list-style-type: none"> • Check that the cable is connected to the mains. • Check that the plug and cable are not damaged. • Check for a blown fuse. • Check if the battery indicator lamp in the remote control handle responds (certain models only).
The s-bag® indicator light is illuminated	<ul style="list-style-type: none"> • Check if the s-bag® is full or blocked. • If you have already changed the s-bag®, change the motor filter.
The filter indicator light is illuminated (only at specific models)	Change, or wash (if washable), the exhaust filter.
The cleaner stops	The cleaner might be overheated: disconnect it from the mains; check if the nozzle, tube, hose or filters are blocked. Let the cleaner cool down for 30 minutes before plugging it in again. If the cleaner still does not work, contact an authorized Electrolux service centre.
Reduction of suction capacity versus normal	<ul style="list-style-type: none"> • Check if the s-bag is full or blocked. • Check if the motor filter is clogged and needs changing. • Check if nozzle is blocked and needs to be cleared. • Check if hose is blocked by squeezing it gently. However, be careful in case the obstruction has been caused by glass or needles caught inside the hose. Note: The warranty does not cover any damage to the hose caused by cleaning it.
Water has been sucked into the vacuum cleaner	It will be necessary to replace the motor at an authorized Electrolux service centre. Damage to the motor caused by the penetration of water is not covered by the warranty.

For any further problems, contact an authorized Electrolux service centre.

Obsah je uzamčen

Dokončete, prosím, proces objednávky.

Následně budete mít přístup k celému dokumentu.



Proč je dokument uzamčen? Nahněvat Vás rozhodně nechceme. Jsou k tomu dva hlavní důvody:

- 1) Vytvořit a udržovat obsáhlou databázi návodů stojí nejen spoustu úsilí a času, ale i finanční prostředky. Dělali byste to Vy zadarmo? Ne*. Zakoupením této služby obdržíte úplný návod a podpoříte provoz a rozvoj našich stránek. Třeba se Vám to bude ještě někdy hodit.

**) Možná zpočátku ano. Ale vězte, že dotovat to dlouhodobě nelze. A rozhodně na tom nezbohatneme.*

- 2) Pak jsou tady „roboti“, kteří se přiživují na naší práci a „vysávají“ výsledky našeho úsilí pro svůj prospěch. Tímto krokem se jim to snažíme překazit.

A pokud nemáte zájem, respektujeme to. Urgujte svého prodejce. A když neuspějete, rádi Vás uvidíme!