



PRO powered by **BRAUN**

500-900



Charger Type 3757
Handle Type 3756



92692116



UK 0 800 731 1792

IE 1 800 509 448

PL 801 127 286
801 1 BRAUN

CZ 800 11 33 22

SK 800 333 233

HU (06-1) 451-1256

HR 01/66 90 330

SI 080 2822

LT (8 5) 205 1272

LV 67798667

EE 667 5047

IL 1-800-666-775

Internet:

www.oralb.com

www.braun.com

www.service.braun.com

Braun GmbH
Frankfurter Straße 145
61476 Kronberg/Germany

Charger type 3757

Handle type 3756

91776925/III-18

EN/PL/CZ/SK/HU/HR/SI/LT/LV/EE/IL

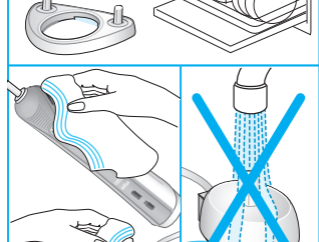
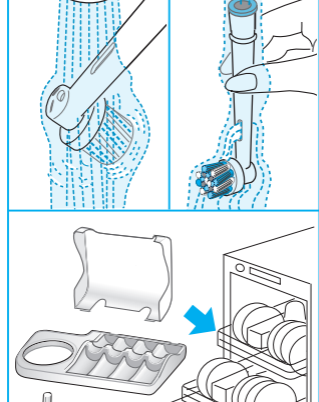
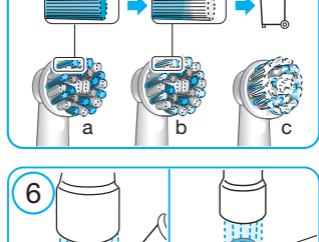
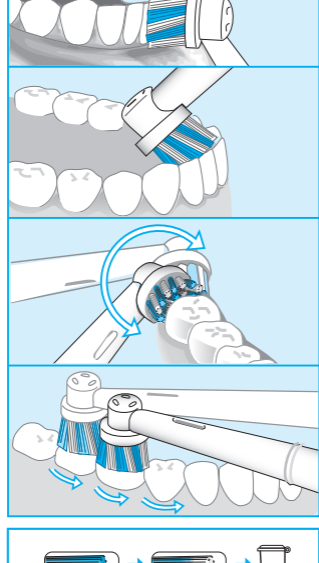
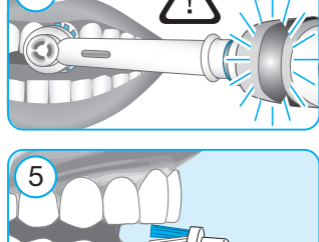
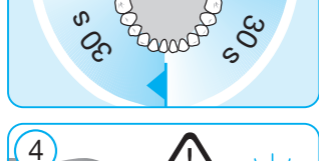
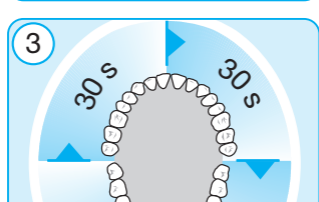
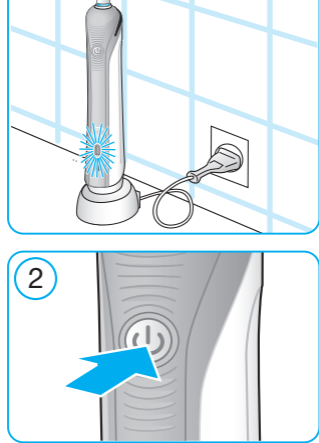
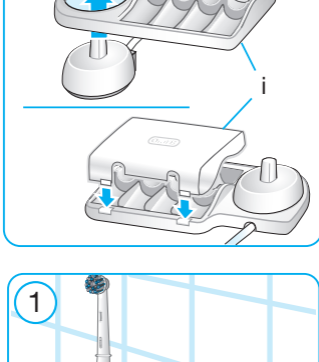
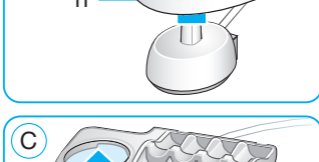
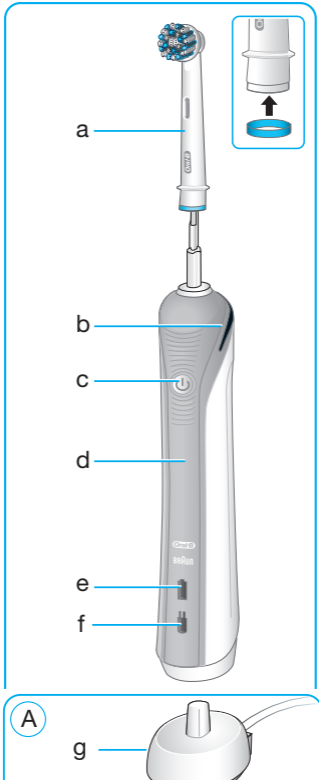

English

Your Oral-B® toothbrush has been carefully designed to offer you and your family a unique brushing experience that is both safe and effective.

IMPORTANT

- Periodically check the entire product/cord for damage. A damaged or non-functioning unit should no longer be used. If the product/cord is damaged, take it to an Oral-B Service Centre. Do not modify or repair the product. This may cause fire, electric shock or injury.
- Usage by children under age 3 is not recommended. Toothbrushes can be used by children and persons with reduced physical, sensory or mental capabilities or lack of experience and knowledge, if they have been given supervision or instruction concerning use of the appliance in a safe way and understand the hazards involved.
- Cleaning and maintenance shall not be performed by children.
- Children shall not play with the appliance.
- Use this product only for its intended use as described in this manual. Do not use attachments which are not recommended by the manufacturer. Only use charger provided with your appliance.

WARNING

- Do not place the charger in water or liquid or store where it can fall or be pulled into a tub or sink. Do not reach for it when fallen into water. Unplug immediately.
 - This appliance contains batteries that are non-replaceable. Do not open and disassemble device. For battery recycling please dispose whole device according to local environmental regulations. Opening the handle will destroy the appliance and invalidate the warranty.
 - When unplugging, always hold the power plug instead of the cord. Do not touch the power plug with wet hands. This can cause an electric shock.
 - If you are undergoing treatment for any oral care condition, consult your dental professional prior to use.
 - This toothbrush is a personal care device and is not intended for use on multiple patients in a dental practice or institution.
- To avoid brush head breakage which may generate a small parts choking hazard or damage teeth:
- Prior to each use, ensure the brush head fits well. Discontinue use of the toothbrush, if brush head no longer fit properly. Never use without a brush head.
 - If the toothbrush handle is dropped, the brush head should be replaced before the next use even if no damage is visible.
 - Replace brush head every 3 months or sooner if brush head becomes worn.
 - Clean brush head properly after each use (see «Cleaning recommendations» paragraph). Proper cleaning ensures the safe use and functional life of the toothbrush.

Description

- a Brush head
- b Pressure sensor light (depending on model)
- c On/off button (mode selection)
- d Handle
- e Charge indicator light
- f Low charge indicator light
- g Charger

Accessories (depending on model):

- h Brush head holder
- i Brush head compartment with protective cover

Note: Content may vary based on the model purchased.

Specifications

For voltage specifications refer to the bottom of the charging unit.

Noise level: ≤65 dB (A)

Connecting and charging

Your toothbrush has a waterproof handle, is electrically safe and designed for use in the bathroom.

- Plug the basic charger (g) or the assembled charging unit (picture B/C) into an electrical outlet and place the toothbrush handle (d) on the charging unit.
- The green charge indicator light (e) flashes while the handle is being charged. Once it is fully charged, the light turns off. A full charge can take up to 22 hours and enables up to 10 days of regular brushing (twice a day, 2 minutes) (picture 1).
Note: After deep discharge, the green light might not flash immediately; it can take up to 10–15 minutes.
- If the rechargeable battery is low the red low charge indicator light (f) is flashing for some seconds when turning your toothbrush on/off.
- For everyday use, the toothbrush handle can be stored on the charging unit to maintain it at full power. Overcharging is impossible.
- To maintain the maximum capacity of the rechargeable battery, unplug the charging unit and fully discharge the handle with regular use at least every 6 months.

Using your toothbrush

Brushing technique

Wet brush head and apply any kind of toothpaste. To avoid splashing, guide the brush head to your teeth before switching on the appliance (picture 2). When brushing your teeth with one of the **Oral-B oscillating-rotating brush heads** guide the brush head slowly from tooth to tooth, spending a few seconds on each tooth surface (picture 5). When using the **Oral-B «TriZone» brush head** place the toothbrush bristles against the teeth at a slight angle towards the gumline. Apply light pressure and start brushing in back and forth motions, just like you would do with a manual toothbrush.

With any brush head do not forget to brush all 3 surfaces of your teeth: chewing, outer and inner surfaces. Brush all four quadrants of your mouth equally. You may also consult your dentist or dental hygienist about the right technique for you.

Obsah je uzamčen

Dokončete, prosím, proces objednávky.

Následně budete mít přístup k celému dokumentu.



Proč je dokument uzamčen? Nahněvat Vás rozhodně nechceme. Jsou k tomu dva hlavní důvody:

- 1) Vytvořit a udržovat obsáhlou databázi návodů stojí nejen spoustu úsilí a času, ale i finanční prostředky. Dělali byste to Vy zadarmo? Ne*. Zakoupením této služby obdržíte úplný návod a podpoříte provoz a rozvoj našich stránek. Třeba se Vám to bude ještě někdy hodit.

**) Možná zpočátku ano. Ale vězte, že dotovat to dlouhodobě nelze. A rozhodně na tom nezbohatneme.*

- 2) Pak jsou tady „roboti“, kteří se přiživují na naší práci a „vysávají“ výsledky našeho úsilí pro svůj prospěch. Tímto krokem se jim to snažíme překazit.

A pokud nemáte zájem, respektujeme to. Urgujte svého prodejce. A když neuspějete, rádi Vás uvidíme!