

# AKAI

MODEL:SS026A-Kastor

## Manualul Utilizatorului BOXĂ COLOANĂ 1.0



**Vă rugăm să citiți cu atenție acest manual înainte de a opera unitatea. Astfel preveniți defecțiunile și puteți experimenta toate caracteristicile noului echipament.**

**ATENȚIONARE**

**ATENȚIE**

Simbolul fulger cu săgeată în sus înseamnă pericol de electrocutare. Simbolul fulger cu săgeată în jos înseamnă pericol de electrocutare din cauza sarcinii reziduale.

Simbolul de exclamare într-un triunghi avertisează că produsul conține substanțe periculoase sau că este necesar să se respecte anumite instrucțiuni importante de operare și mentenanță (servis) în documentația care însoțește produsul.

**DESCRIEREA PANOULUI DE COMANDE AL SUBWOOFER-ULUI**

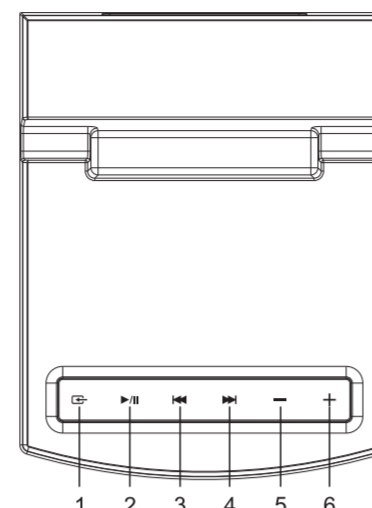

- Intrare
- Redare/Pauză
- Anterior
- Următor
- Ajustarea volumului „+”
- Ajustarea volumului „-”

**ALIMENTARE CA**

**NOTE IMPORTANTE**

**INSTALAREA BATERIILOR**

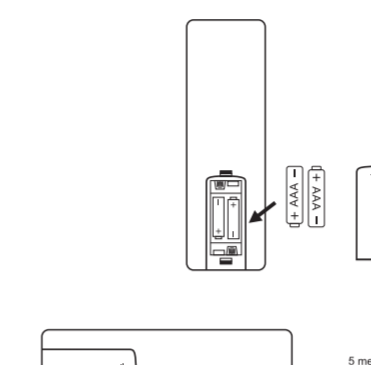

**DESCRIEREA TELECOMANZII**

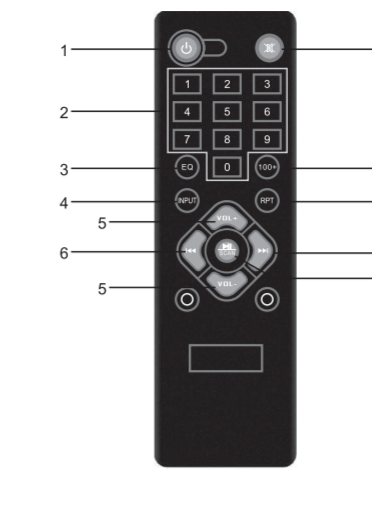

- STANDBY: folosiți acest buton pentru a porni subwoofer-ul
- 1-9: evidențiere număr
- EQ MODE/EQ OFF: folosiți acest buton pentru reglarea frecvențelor audio
- INPUT: selectați sursa de intrare
- VOLUME +/-: măriți/micșorati volumul
- PREV: reveniți la mediul anterior
- MUTE: folosiți pentru a dezactiva sunetul
- 100+: folosiți pentru a selecta o redare piesă muzicală prezentă după 100 de piese
- REPEAT: repeteți redarea audio
- NEXT: treciți la mediul următor
- PLAY/PAUSE: începeți sau întrerogați redarea de pe USB sau SD/MMC

**DESCRIEREA PANOULUI DIN SPATE AL SUBWOOFER-ULUI**

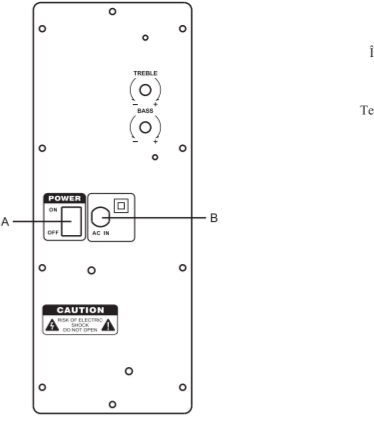

**UNITATEA DE LEDURI**

**FUNCȚIUNI DE CETOCHIRE**

**CARACTERISTICI**

**SPECIFICAȚII**

**DEZINSTALAREA ECHIPAMENTULUI ELECTRICE ȘI ELECTRONICE LAZATE**

# AKAI

MODEL:SS026A-Kastor

## User Manual 1.0 TOWER SPEAKER



**Please read this manual carefully before starting to operate the unit. This prevents malfunctions and lets you experience all features of your new equipment.**

**SAFETY PRECAUTION**

**CAUTION**

**IMPORTANT SAFETY INSTRUCTIONS**

**DISPOSAL OF WASTE ELECTRICAL AND ELECTRONIC EQUIPMENT**

**DESCRIPTION OF THE SUBWOOFER CONTROL PANEL**

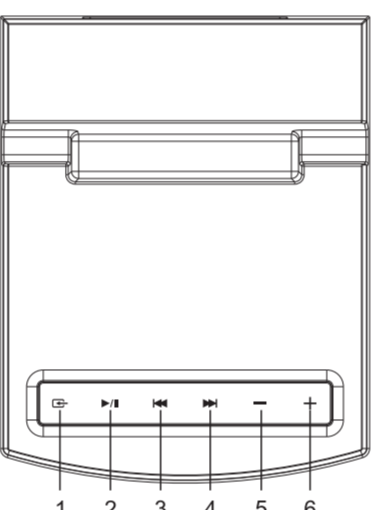

- Input
- Play/pause
- Previous
- Next
- Volume+ adjustment
- Volume- adjustment

**AC POWER**

**IMPORTANT NOTES**

**BATTERY INSTALLATION**

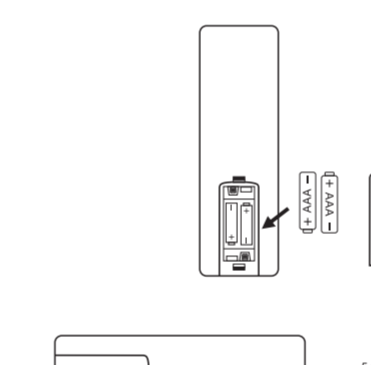

**DESCRIPTION OF THE REMOTE CONTROL**

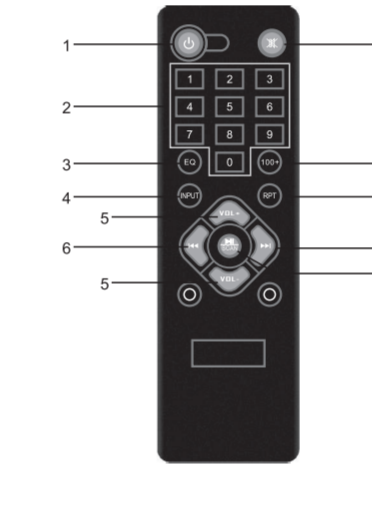

- STANDBY: press this button to turn on/off the subwoofer
- 1-9: To choose 1-9 Numerical track
- EQ MODE/EQ OFF: To choose audio output sound field effect
- INPUT: cycle selection between input USB/SD/FM/AUX/BT
- VOLUME +/-: Increase volume or reduce the volume
- PREV: skip to the previous track
- MUTE: To mute the sound
- 100+: to select and play the music track present after the 100 tracks
- REPEAT: Repeat an audio track
- NEXT: Skip to the next track
- PLAY/PAUSE: Begin play or pause the BT mode automatically

**SUBWOOFER REAR SIDE DESCRIPTION**

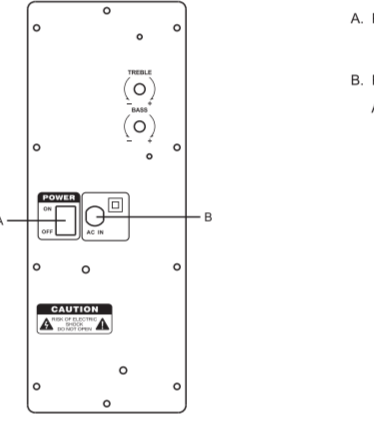

**UNIT OPERATION**

**BT Operating:**

**FEATURES**

**SPECIFICATIONS**

# AKAI

MODEL:SS026A-Kastor

## ΟΔΗΓΙΕΣ ΧΡΗΣΗΣ 1.0 ΗΧΕΙΟ ΠΥΡΓΟΣ



**Παρακαλούμε διαβάστε προσεκτικά αυτό το εγχειρίδιο πριν αρχίσετε να λειτουργείτε τη συσκευή. Αυτό προλαμβάνει δυσλειτουργίες και σας επιτρέπει να απολαύσετε όλες τις δυνατότητες του νέου σας εξοπλισμού.**

**SAFETY PRECAUTION**

**CAUTION**

**ΣΗΜΑΝΤΙΚΕΣ ΟΔΗΓΙΕΣ ΑΣΦΑΛΕΙΑΣ**

**ΔΙΑΘΕΣΗ ΑΦΟΡΤΩΣΗ ΗΛΕΚΤΡΙΚΟΥ ΚΑΙ ΗΛΕΚΤΡΟΝΙΚΟΥ ΕΞΟΠΛΙΣΜΟΥ**

**ΠΕΡΙΓΡΑΦΗ ΤΟΥ ΚΕΝΤΡΟΥ ΕΛΕΓΧΟΥ ΤΟΥ SUBWOOFER**

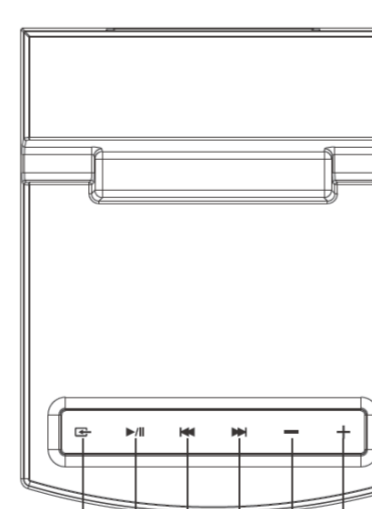

- Είσοδος
- Αναπαραγωγή/Παύση
- Προηγούμενο
- Επόμενο
- Ένταση + ρύθμιση
- Ένταση - ρύθμιση

**AC ΙΕΧΥΣ**

**ΣΗΜΑΝΤΙΚΕΣ ΣΗΜΕΙΩΣΕΙΣ**

**ΥΠΟΒΟΛΗ ΜΠΑΤΗΡΙΑΣ**

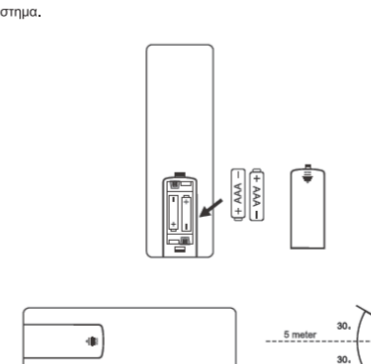

**ΠΕΡΙΓΡΑΦΗ ΚΕΡΑΤΩΝ**

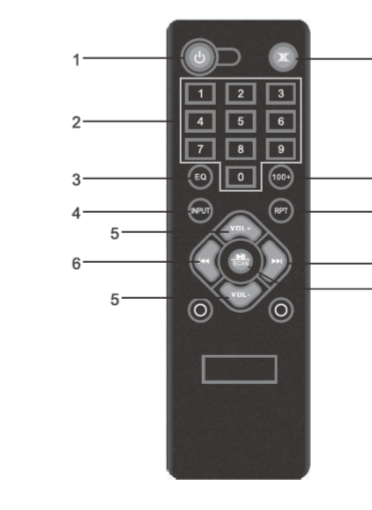

- ΑΜΑΧΟΝΙΟ: Πατήστε αυτό το κουμπί για ενεργοποίηση/απενεργοποίηση του κεντραρίου
- 1-9: Για να επιλέξετε αριθμητικό ένα κουμπί
- EQ MODE/EQ OFF: Για εναλλαγή μεταξύ των ηχοειστών audio field effect
- INPUT: Κλικ για επιλογή της πηγής εισόδου USB/SD/FM/AUX/BT
- VOL+ /VOL-: Αύξηση ή μείωση της έντασης
- PREVIOUS: Επιστροφή προηγούμενου κομματιού
- STOP: Για σίγαση του ήχου
- 100+: Για επιλογή και αναπαραγωγή μουσικού κομματιού μετά από 100 κομμάτια
- REPEAT: Επανάληψη ενός ηχοεισμού κομματιού
- NEXT: Επόμενο κομμάτι
- PLAY/PAUSE: Ξεκίνησε ή παύση του USB ή SD/MMC

**ΠΕΡΙΓΡΑΦΗ ΤΗΣ ΠΛΑΤΗΣ ΠΙΝΑΚΑ ΤΟΥ SUBWOOFER**

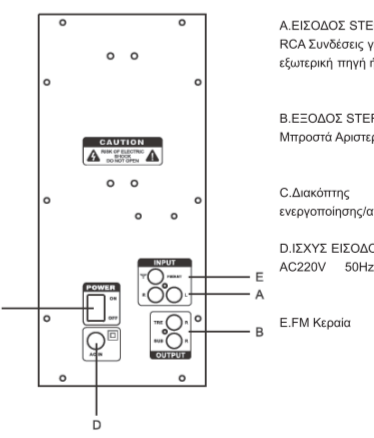

**ΑΙΤΙΟΛΟΓΙΑ ΜΟΝΩΣΙΑΣ**

**ΒΛΕΠΟΤΗΤΑ ΣΥΝΔΕΣΗ**

**ΚΑΡΑΚΤΗΡΙΣΤΙΚΑ**

**ΠΡΟΒΛΗΨΕΙΣ**