

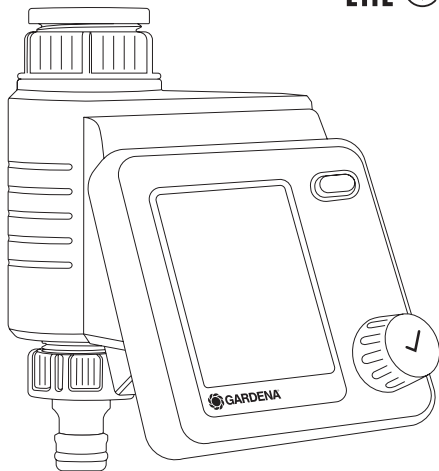

Master Art. 1892



PL Instrukcja obsługi
Sterowanie nawadnianiem

HU Használati utasítás
Öntözésvezérlés

CS Návod k obsluze
Řízení zavlažování

SK Návod na obsluhu
Riadenie zavlažovania

RU Инструкция по эксплуатации
Блок управления поливом

SL Navodilo za uporabo
Upravljalnik zalivanja

HR Upute za uporabu
Kontroler navodnjavanja

UK Інструкція з експлуатації
Блок керування поливом

RO Instrucțiuni de utilizare
Programator de udare

TR Kullanma Kılavuzu
Sulama Bilgisayarı ve aparatı

BG Инструкция за експлоатация
Система за контрол на напояването

SQ Manual përdorimi
Sistemi i kontrollit të vaditjes

PL

HU

CS

SK

RU

SL

HR

UK

RO

TR

BG

SQ

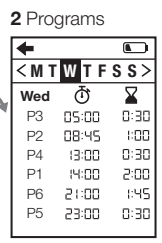
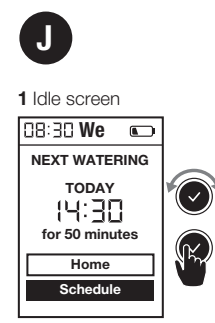
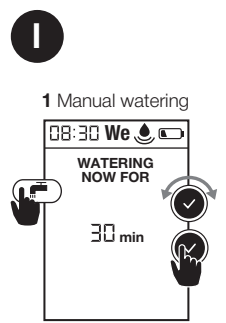
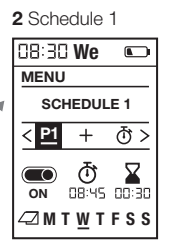
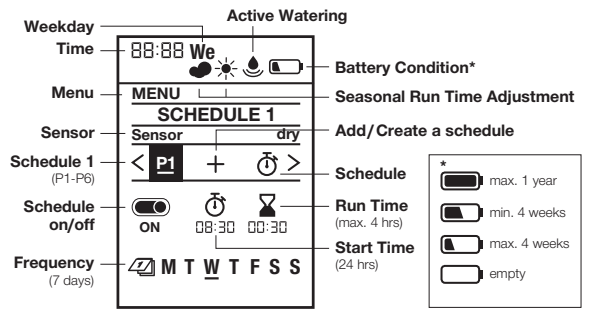
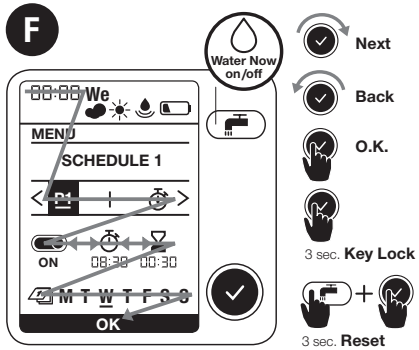
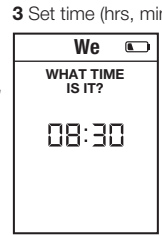
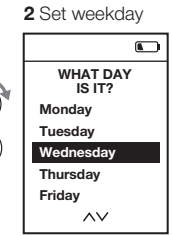
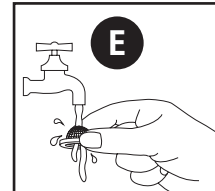
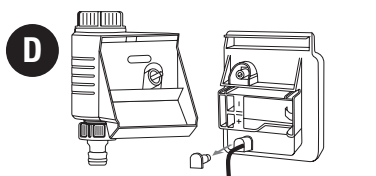
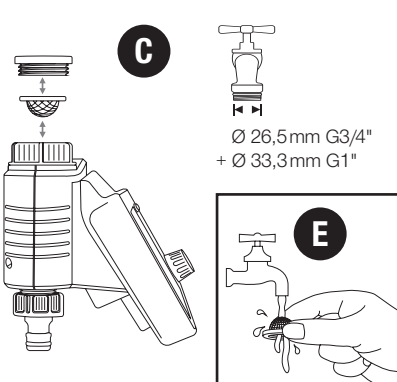
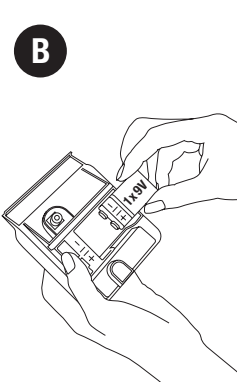
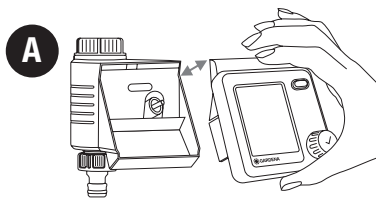

K

- 1 Menu: Seasonal Run Time 2 Regular Run Time 3 Reduce Watering

**L**

- 1 Menu: Rain pause 2 Pause / 3 days

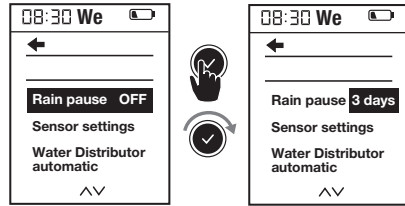
**O****+**

Art. 1197

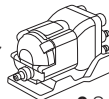

- 1 Menu: Water Distributor automatic 2 Select amount of active water lines 3 Create schedule 1-6 4 Sensor per line (optional) 5 Schedule L1

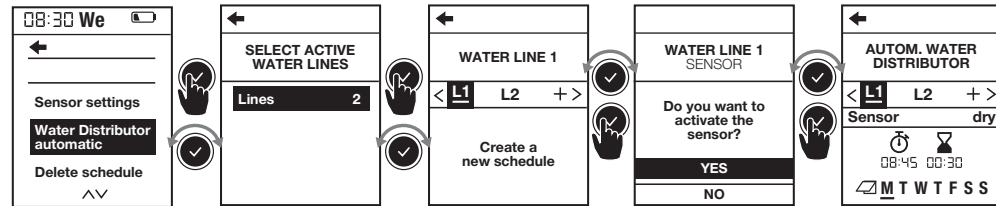
**M**

- 1 Menu: Delete schedule 2 Delete schedule 1

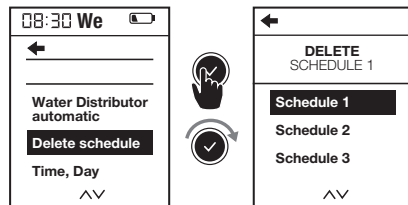
**N****+**

Art. 1188



- 1 Menu: Soil Moisture Sensor 2 Sensor settings

**P**

- 1 Menu: Time, Day 2 Set Time, Day

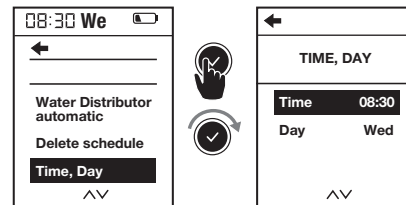
**Q**

- 1 Menu: Language preference 2 Select Language preference



Obsah je uzamčen

**Dokončete, prosím, proces objednávky.
Následně budete mít přístup k celému dokumentu.**



Proč je dokument uzamčen? Nahněvat Vás rozhodně nechceme. Jsou k tomu dva hlavní důvody:

1) Vytvořit a udržovat obsáhlou databázi návodů stojí nejen spoustu úsilí a času, ale i finanční prostředky. Dělali byste to Vy zadarmo? Ne*. Zakoupením této služby obdržíte úplný návod a podpoříte provoz a rozvoj našich stránek. Třeba se Vám to bude ještě někdy hodit.

**) Možná zpočátku ano. Ale vězte, že dotovat to dlouhodobě nelze. A rozhodně na tom nezbohatneme.*

2) Pak jsou tady „roboti“, kteří se přiživují na naší práci a „vysávají“ výsledky našeho úsilí pro svůj prospěch. Tímto krokem se jim to snažíme překazit.

A pokud nemáte zájem, respektujeme to. Urgujte svého prodejce. A když neuspějete, rádi Vás uvidíme!