



# Instruction Book

EKM3xxx  
Kitchen Machine



**GB** INSTRUCTION BOOK

**FR** MODE D'EMPLOI

**AR** كتيب الإستخدام

**BG** БРОШУРА С ИНСТРУКЦИИ

**CZ** NÁVOD K POUŽITÍ

**DE** GEBRAUCHSANWEISUNG

**DK** VEJLEDNING

**EE** KASUTUSJUHEND

**ES** LIBRO DE INSTRUCCIONES

**FA** دفترچه راهنمای کاربر

**FI** OHJEKIRJA

**GR** ΕΓΧΕΙΡΙΔΙΟ ΟΔΗΓΙΩΝ

**HR** KNJIŽICA S UPUTAMA

**HU** HASZNÁLATI ÚTMUTATÓ

**IT** ISTRUZIONI

**LT** INSTRUKCIJŲ KNYGA

**LV** LIETOŠANAS INSTRUKCIJA

**NO** BRUKSANVISNING

**PL** INSTRUKCJA OBSŁUGI

**RO** MANUAL DE INSTRUCȚIUNI

**RS** UPUTSTVO

**RU** ИНСТРУКЦИЯ

**SE** BRUKSANVISNING

**SI** NAVODILA

**SK** NÁVOD NA POUŽÍVANIE

**TR** EL KİTABI

**UA** ПОСІБНИК КОРИСТУВАЧА



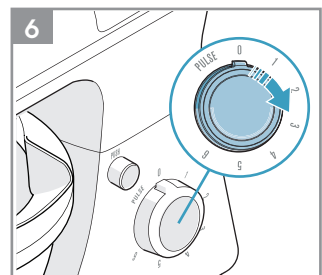
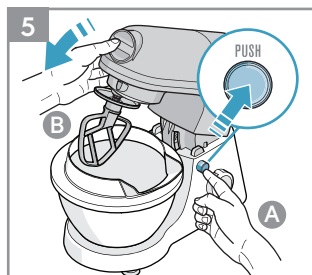
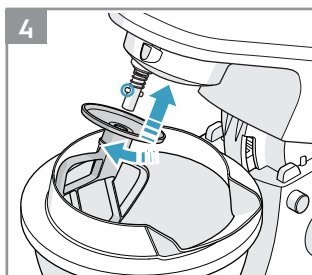
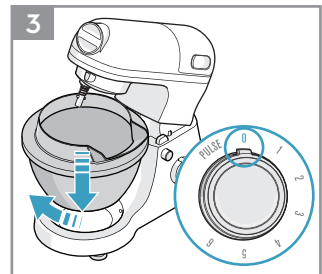
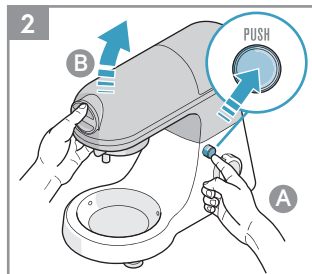
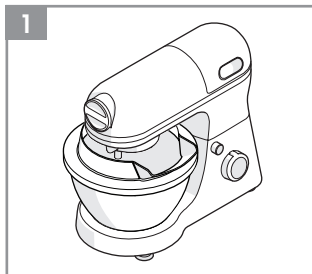
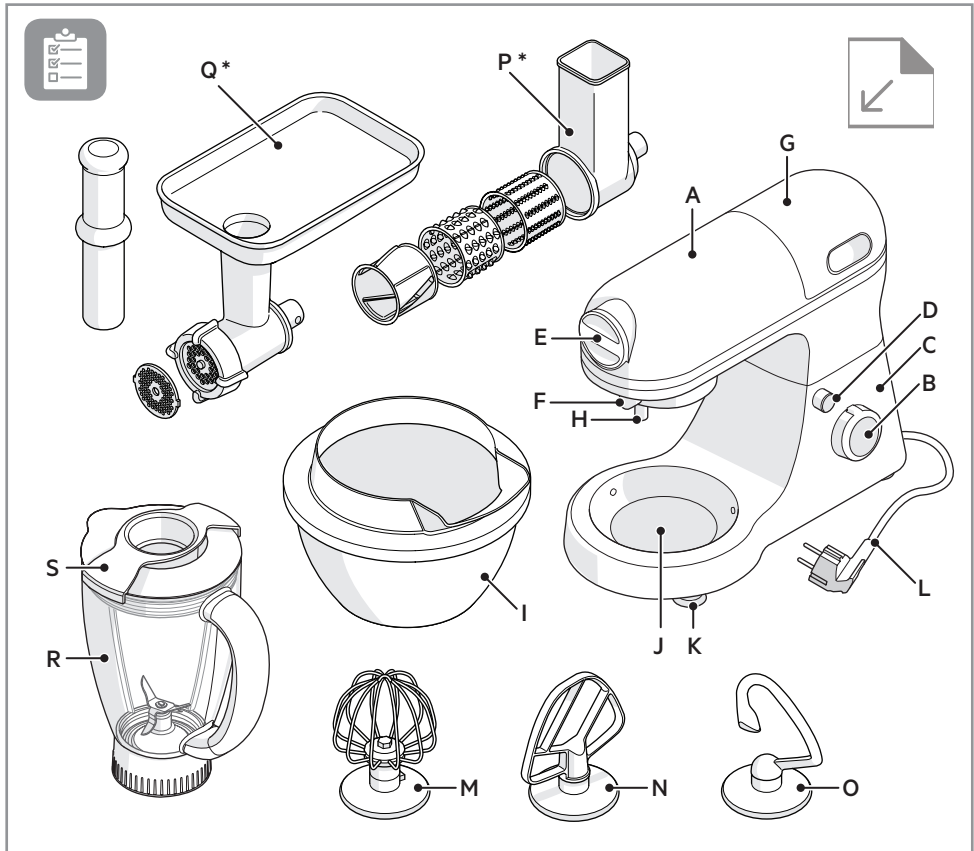

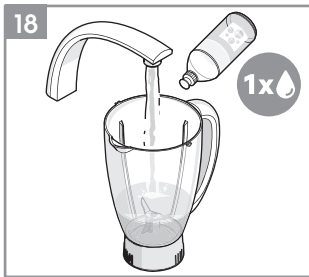
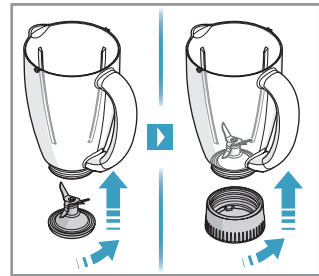
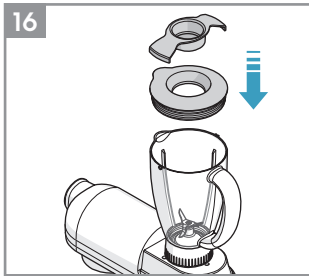
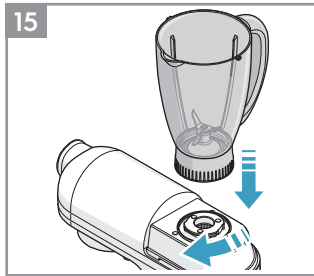
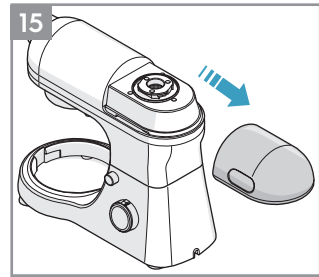
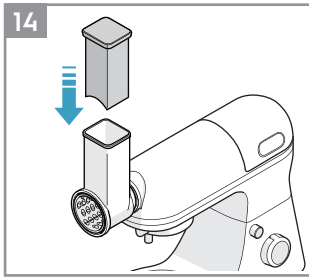
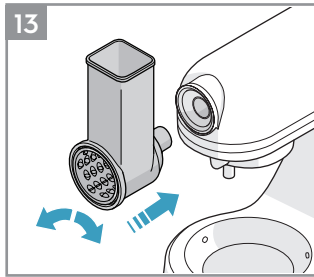
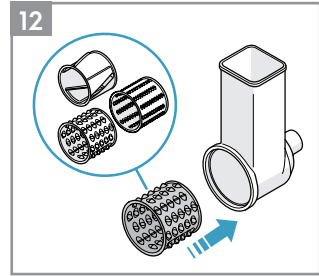
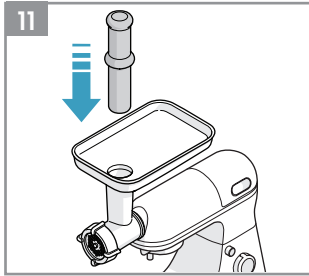
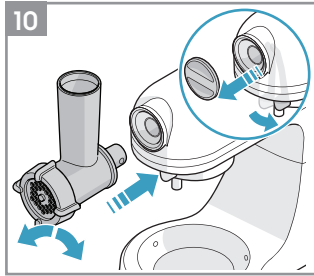
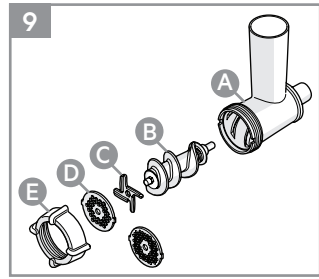
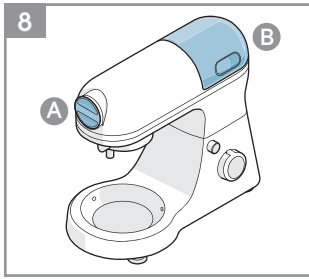
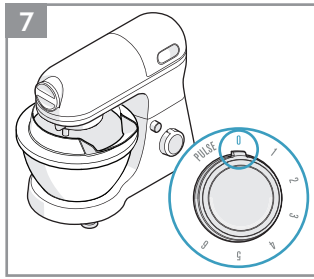

# Obsah je uzamčen

**Dokončete, prosím, proces objednávky.**

**Následně budete mít přístup k celému dokumentu.**



**Proč je dokument uzamčen? Nahněvat Vás rozhodně nechceme. Jsou k tomu dva hlavní důvody:**

- 1) Vytvořit a udržovat obsáhlou databázi návodů stojí nejen spoustu úsilí a času, ale i finanční prostředky. Dělali byste to Vy zadarmo? Ne\*. Zakoupením této služby obdržíte úplný návod a podpoříte provoz a rozvoj našich stránek. Třeba se Vám to bude ještě někdy hodit.

*\*) Možná zpočátku ano. Ale vězte, že dotovat to dlouhodobě nelze. A rozhodně na tom nezbohatneme.*

- 2) Pak jsou tady „roboti“, kteří se přiživují na naší práci a „vysávají“ výsledky našeho úsilí pro svůj prospěch. Tímto krokem se jim to snažíme překazit.

A pokud nemáte zájem, respektujeme to. Urgujte svého prodejce. A když neuspějete, rádi Vás uvidíme!