

# BRAUN

## Saphir-jet

**PV 1502** Type 4685

**PV 1505** Type 4315

**PV 1510** Type 4684

**PV 1512** Type 4687

## Steam iron

[English](#)  
Use Instructions  
Guarantee  
Service Centers

## English

### Super hard sole plate

Your Braun steam iron has a unique sole plate made out of a special resistant alloy, polished with sapphire particles. This process developed by Braun makes the sole plate extremely durable and scratch resistant. Even ironing over sharp-edged fasteners, studs or zippers will not cause scratches that may snag or damage sensitive fabric. Thanks to its extra hardness, this sole plate will maintain its easy gliding properties throughout the life of the iron.

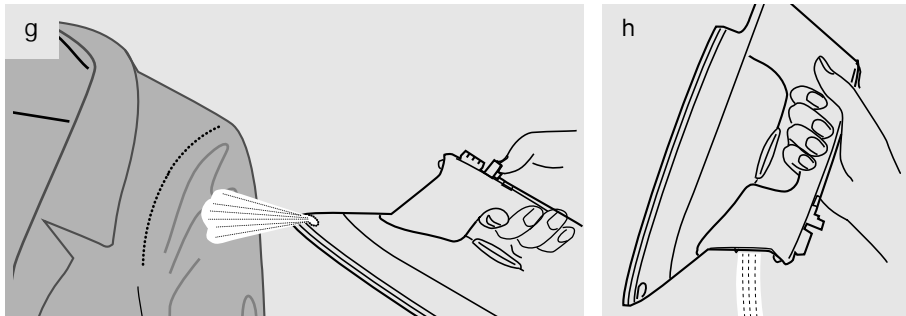
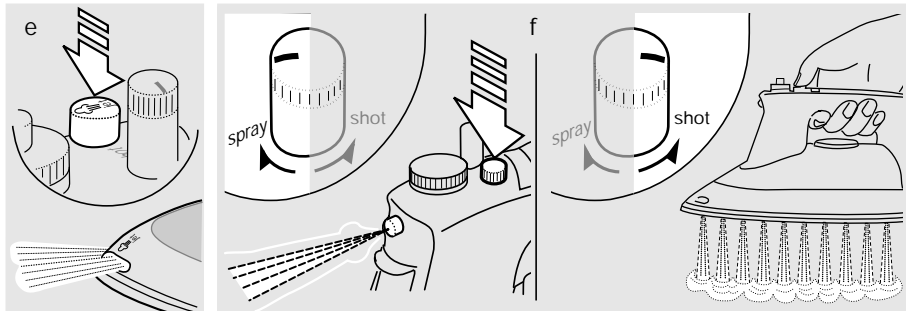
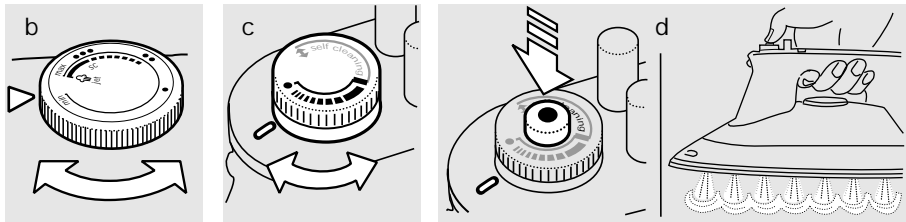
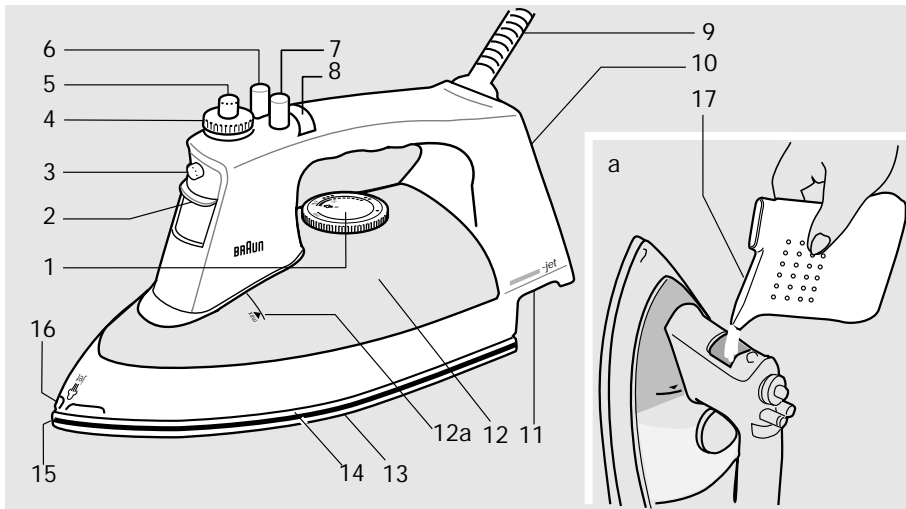

Our products are engineered to meet the highest standards of quality, functionality and design. We hope you thoroughly enjoy your new Braun steam iron.

**Notice:** Should the sole plate of your model have a protective plastic covering, take it off before using the iron.

#### Important Safeguards

- **Read all instructions carefully before using the iron. Keep the use instructions during the entire life of the iron.**
- Before filling with water, always disconnect the plug from the socket first.
- Always pull the plug and not the cord.
- Electric irons reach high temperatures during operation that could lead to burns.
- Keep the iron away from children, and when it is turned on, keep the unit under supervision.
- Disconnect the plug when leaving the room where you are ironing, even if it is only briefly.
- Never iron or dampen clothes while wearing them.
- During ironing pauses, always place the iron upright in its heel rest.
- Never immerse the iron in water or other liquids.
- The cord should never come into contact with hot objects or the sole plate.
- Check the cord periodically for possible damage.
- Do not use a damaged iron.
- Take it to a Braun Service Center for repair.
- Braun electric appliances meet applicable safety standards.
- This appliance can only be opened by an authorised Braun Service Centre for repairs.
- The cord of this appliance may only be replaced by an authorised Braun Service Centre since special tools are required.
- Faulty, unqualified repair work may cause accidents or injury to the user.
- Make sure your voltage corresponds to that printed on the iron. Connect the iron to an alternating current (~) outlet only.

#### Table of features for each model

Made in Spain 230 V ~ / 50 - 60 Hz / 1300 W  
Type: 4 \_\_\_ Model: PV 1 \_\_\_

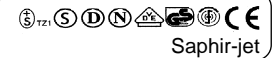

**BRAUN**

Saphir-jet

Feature:	Model: Type:	PV 1502 4685	PV 1505 4315	PV 1510 4684	PV 1512 4687
Jet of steam		●	●	●	●
Shot of steam				●	●
Extra steam			●		●
Spray		●	●	●	●

#### Specifications

Voltage/wattage: See typeplate at the bottom of the unit.  
Water tank capacity: 215 cc (approximately 1 filling beaker ⑰ of water filled up to the mark = 1 tank filling).

#### Description

- ① Temperature selector
- ② Water tank with sliding shutter opening
- ③ Water spray nozzle
- ④ Steam regulator / self-cleaning activator and anti-calc. valve
- ⑤ Extra steam button

- ⑥ Jet of steam button
- ⑦ 1- or 2-function button (water-spray/ shot of steam, see «Table of features»)
- ⑧ Pilot light
- ⑨ Swivel cord
- ⑩ Heel rest
- ⑪ Cord storage/typeplate
- ⑫ Transparent water tank
- ⑬ Maximum marking («max.»)
- ⑭ Sole plate with 71 steam vents
- ⑮ Full-length button groove
- ⑯ Slim pointed tip
- ⑰ Jet of steam outlet
- ⑱ Filling beaker

## Praktical Guidelines

### Type of Water to be Used

- This iron is designed for tap water. However, if you have hard water we recommend to use:
- filtered water (household water filters that also de-mineralize water are commercially available) or
  - a mixture of 1/2 part tap water and 1/2 part distilled water from drug stores or grocery stores.

**Important:** Never use distilled water (battery water). Do not add any additives (e. g. starch) to the water.

### To fill iron

1. Pull the plug out of the wall outlet.
2. Put the steam regulator ④ in position «●» (= steam off).
3. Open sliding shutter ②.
4. Place the iron in the upright position and fill with water slowly through the tank opening ② to the «max.» marking ⑩ (a), using the beaker ⑰.
5. Close sliding shutter.

### Selecting the temperature

Connect the iron to a safely located wall outlet and select the ironing temperature with the temperature selector ① (b). As soon as the pilot light ③ goes out, the iron has reached the temperature selected. To avoid water dripping, always rest the iron upright while heating it up keep the steam regulator ④ in position «●» (= steam off) (c).

You will usually find the following symbols in your garments:



The temperature selector ① is marked with these symbols:

- min. The iron is connected
- Synthetics (acrylic, acetate)
- Silk/rayon/nylon/polyester/cotton blends/wool
- Cotton/linen
- max. Linen

Select the temperature you need according to these symbols.

### Spray, shot of steam, jet of steam

Before you start ironing, we recommend to press the buttons 3 or 4 times, in order to activate these functions.

### Dry ironing

Set the steam regulator ④ in position «●» (= steam off) (c) for dry ironing. The water spray ⑦ may be used at any temperature setting to dampen the laundry. The jet of steam ⑥ and the shot of steam ⑦ buttons can be activated during dry ironing, provided that the temperature selector ① is within the continuous red area ⑱.

### Steam ironing

(see «Table of features»)

**Temperature selection:** Set the temperature selector ① within the red range steam (b) and wait until the iron has reached the selected temperature (i. e. the pilot light ③ goes off). Steam ironing is possible in the entire red range. Steam ironing at lower temperatures may cause water drops instead of steam. Should this happen, turn the steam regulator ④ to the position «●» (= steam off) (c).

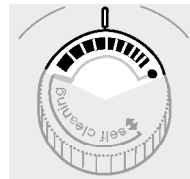

**Steam regulator ④:** Select the quantity of steam required (c) for each garment with the steam regulator ④. You can increase the quantity by turning the steam regulator clockwise (wide markings) to the end of the red marking.

**Caution:** While ironing do not turn the steam regulator further, otherwise hot water may come out from the sole plate (see section «Decalcifying/Self-cleaning»).

By turning the steam regulator anti-clockwise you can reduce the quantity of steam or turn the steam off «●» (= steam off) (see «Ironing Guide»).

**Constant steam:** Your Braun steam iron is equipped with a special tank configuration to provide constant steam even when the water level in the tank is low.

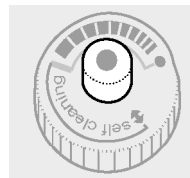

**«Extra steam»\*** (coming from the steam vents in the sole plate): For stubborn creases and wrinkles, collars and cuffs. When ironing within the red range ⑱

area the extra steam function can be used. You can press the button ⑤ (d) for 3 seconds at intervals of no less than 7 seconds.

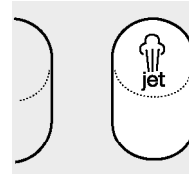

this function.

When ironing within the red range ⑱ area the jet of steam function ⑥ can be used (e). To do so, press the button ⑥ at intervals of no less than 5 seconds. The jet of steam has been designed not only for steaming hard to reach areas like pleats, inside of pockets etc., but also for steaming hanging clothing (e. g. velvet skirts, curtains, etc.) (g). The jet of steam functions between horizontal and upright positions. Be careful not to touch sensitive textiles with the hot sole plate.

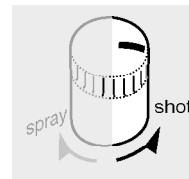

**Shot of steam\*** (coming from the vents in the sole plate): When ironing within the red area the shot of steam function can be used. It gives an extra, particularly powerful shot of steam penetrating deep into the textiles in order to straighten creases, collars and pleats. The function «shot of steam» can be used in normal ironing and also vertically for steaming hanging clothing (e. g. velvet skirts, curtains etc.) (g). Press the shot of steam button ⑦ at intervals of no less than 5 seconds. When steaming be careful not to touch sensitive textiles with the hot sole plate.

\* If pressed too frequently, it can drip. Should this happen, wait a few seconds before using it again.

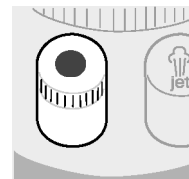

**Spray** (coming from the nozzle ③): The spray function can be used at any temperature, to dampen laundry. To do so, press the button ⑦ (water spray = blue).

**Jet of steam\*** (coming from the outlets ⑯ at the slim pointed tip ⑮): **Caution: Keep children away from the jet of steam and do not hold your fingers in front of the outlets ⑯ when activating**

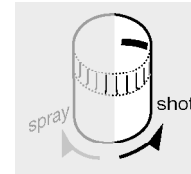
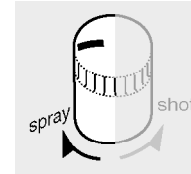

and from red to blue clockwise (f).

**Spray / shot of steam 2-function button:**

With the models 4684 and 4687 the functions «water spray» and «shot of steam» can be activated with a 2-function button. The desired function can be selected by turning the button ⑦ as far as it will go. The marking (blue = water spray or red = shot of steam) must point to the respective function (f). Turn the button from blue (spray) to red (shot of steam) anti-clockwise

### Storage

After ironing, always pull the plug out of the wall outlet. Set the temperature selector ① to «min.» (b) and the steam regulator ④ to «●» (= steam off) (c). To empty the iron hold it with the open water tank opening ② downwards (h) and shake it 1 or 2 times. The swivel cord ⑨ conveniently winds up around the cord storage ⑱.

**IMPORTANT:** Store the cool steam iron in a dry place and always standing on its heel rest ⑩. The sole plate may be damaged by remaining water if it is stored horizontally. The warranty does not cover faults or damage resulting from improper storage of the iron.

### Maintenance and Cleaning

To remove residues of minerals/starch from the sole plate always use steel wool. Never use a scouring pad, vinegar or other chemicals. The steam vents ⑬ and jet of steam outlets ⑯ may be cleaned manually with a toothpick, if necessary. Clean the sole plate regularly if you use starch or other aids on the clothes for ironing.

### Decalcifying / Self-cleaning

Braun irons Saphir-jet have a built-in system (anti-calc. valve) to prevent calcification. It allows you to clean residues from the steam chamber. Do not use commercial decalcifiers; they may damage the sole plate. We recommend to use the self-cleaning function every 3 months.

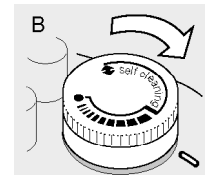
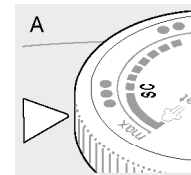

# Obsah je uzamčen

**Dokončete, prosím, proces objednávky.**

**Následně budete mít přístup k celému dokumentu.**



**Proč je dokument uzamčen? Nahněvat Vás rozhodně nechceme. Jsou k tomu dva hlavní důvody:**

- 1) Vytvořit a udržovat obsáhlou databázi návodů stojí nejen spoustu úsilí a času, ale i finanční prostředky. Dělali byste to Vy zadarmo? Ne\*. Zakoupením této služby obdržíte úplný návod a podpoříte provoz a rozvoj našich stránek. Třeba se Vám to bude ještě někdy hodit.

*\*) Možná zpočátku ano. Ale vězte, že dotovat to dlouhodobě nelze. A rozhodně na tom nezbohatneme.*

- 2) Pak jsou tady „roboti“, kteří se přiživují na naší práci a „vysávají“ výsledky našeho úsilí pro svůj prospěch. Tímto krokem se jim to snažíme překazit.

A pokud nemáte zájem, respektujeme to. Urgujte svého prodejce. A když neuspějete, rádi Vás uvidíme!