

DENON

AVR-4520CI

INTEGRATED NETWORK AV RECEIVER

Owner's Manual

SAFETY PRECAUTIONS



CAUTION
RISK OF ELECTRIC SHOCK
DO NOT OPEN



CAUTION:
TO REDUCE THE RISK OF ELECTRIC SHOCK, DO NOT REMOVE COVER (OR BACK). NO USER-SERVICEABLE PARTS INSIDE. REFER SERVICING TO QUALIFIED SERVICE PERSONNEL.

The lightning flash with arrowhead symbol, within an equilateral triangle, is intended to alert the user to the presence of uninsulated "dangerous voltage" within the product's enclosure that may be of sufficient magnitude to constitute a risk of electric shock to persons.

The exclamation point within an equilateral triangle is intended to alert the user to the presence of important operating and maintenance (servicing) instructions in the literature accompanying the appliance.

WARNING:
TO REDUCE THE RISK OF FIRE OR ELECTRIC SHOCK, DO NOT EXPOSE THIS APPLIANCE TO RAIN OR MOISTURE.



Hot surface mark

CAUTION:
HOT SURFACE. DO NOT TOUCH.

The top surface over the internal heat sink may become hot when operating this product continuously. Do not touch hot areas, especially around the "Hot surface mark" and the top panel.

IMPORTANT SAFETY INSTRUCTIONS

1. Read these instructions.
2. Keep these instructions.
3. Heed all warnings.
4. Follow all instructions.
5. Do not use this apparatus near water.
6. Clean only with dry cloth.
7. Do not block any ventilation openings. Install in accordance with the manufacturer's instructions.
8. Do not install near any heat sources such as radiators, heat registers, stoves, or other apparatus (including amplifiers) that produce heat.
9. Do not defeat the safety purpose of the polarized or grounding-type plug. A polarized plug has two blades with one wider than the other. A grounding type plug has two blades and a third grounding prong. The wide blade or the third prong are provided for your safety. If the provided plug does not fit into your outlet, consult an electrician for replacement of the obsolete outlet.
10. Protect the power cord from being walked on or pinched particularly at plugs, convenience receptacles, and the point where they exit from the apparatus.
11. Only use attachments/accessories specified by the manufacturer.
12. Use only with the cart, stand, tripod, bracket, or table specified by the manufacturer, or sold with the apparatus. When a cart is used, use caution when moving the cart/apparatus combination to avoid injury from tip-over.
13. Unplug this apparatus during lightning storms or when unused for long periods of time.
14. Refer all servicing to qualified service personnel. Servicing is required when the apparatus has been damaged in any way, such as power-supply cord or plug is damaged, liquid has been spilled or objects have fallen into the apparatus, the apparatus has been exposed to rain or moisture, does not operate normally, or has been dropped.
15. Batteries shall not be exposed to excessive heat such as sunshine, fire or the like.



CAUTION:

To completely disconnect this product from the mains, disconnect the plug from the wall socket outlet. The mains plug is used to completely interrupt the power supply to the unit and must be within easy access by the user.

FCC INFORMATION (For US customers)

1. COMPLIANCE INFORMATION

Product Name: Integrated Network AV Receiver

Model Number: AVR-4520CI

This product complies with Part 15 of the FCC Rules. Operation is subject to the following two conditions: (1) this product may not cause harmful interference, and (2) this product must accept any interference received, including interference that may cause undesired operation.

Denon Electronics (USA), LLC

(a D&M Holdings Company)

100 Corporate Drive

Mahwah, NJ 07430-2041

Tel. (201) 762-6665

2. IMPORTANT NOTICE: DO NOT MODIFY THIS PRODUCT

This product, when installed as indicated in the instructions contained in this manual, meets FCC requirements. Modification not expressly approved by DENON may void your authority, granted by the FCC, to use the product.

3. IMPORTANT

When connecting this product to network hub or router, use only a shielded STP or ScTP LAN cable which is available at retailer.

Follow all installation instructions. Failure to follow instructions could void your authority, granted by the FCC, to use the product.

4. NOTE

This product has been tested and found to comply with the limits for a Class B digital device, pursuant to Part 15 of the FCC Rules. These limits are designed to provide reasonable protection against harmful interference in a residential installation.

This product generates, uses and can radiate radio frequency energy and, if not installed and used in accordance with the instructions, may cause harmful interference to radio communications. However, there is no guarantee that interference will not occur in a particular installation. If this product does cause harmful interference to radio or television reception, which can be determined by turning the product OFF and ON, the user is encouraged to try to correct the interference by one or more of the following measures:

- Reorient or relocate the receiving antenna.
- Increase the separation between the equipment and receiver.
- Connect the product into an outlet on a circuit different from that to which the receiver is connected.
- Consult the local retailer authorized to distribute this type of product or an experienced radio/TV technician for help.

For Canadian customers:

This Class B digital apparatus complies with Canadian ICES-003.

NOTES ON USE

WARNINGS

- Avoid high temperatures.
Allow for sufficient heat dispersion when installed in a rack.
- Handle the power cord carefully.
Hold the plug when unplugging the cord.
- Keep the unit free from moisture, water, and dust.
- Unplug the power cord when not using the unit for long periods of time.
- Do not obstruct the ventilation holes.
- Do not let foreign objects into the unit.
- Do not let insecticides, benzene, and thinner come in contact with the unit.
- Never disassemble or modify the unit in any way.
- Ventilation should not be impeded by covering the ventilation openings with items, such as newspapers, tablecloths or curtains.
- Naked flame sources such as lighted candles should not be placed on the unit.
- Observe and follow local regulations regarding battery disposal.
- Do not expose the unit to dripping or splashing fluids.
- Do not place objects filled with liquids, such as vases, on the unit.
- Do not handle the mains cord with wet hands.
- When the switch is in the OFF (STANDBY) position, the equipment is not completely switched off from MAINS.
- The equipment shall be installed near the power supply so that the power supply is easily accessible.
- Do not keep the battery in a place exposed to direct sunlight or in places with extremely high temperatures, such as near a heater.

CAUTIONS ON INSTALLATION

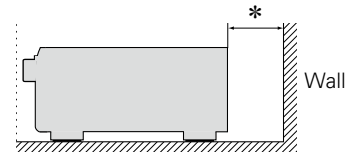
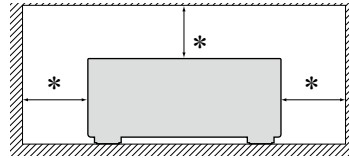

*** For proper heat dispersal, do not install this unit in a confined space, such as a bookcase or similar enclosure.**

- More than 12 in. (0.3 m) is recommended.
- Do not place any other equipment on this unit.

Getting started

Thank you for purchasing this DENON product. To ensure proper operation, please read this owner's manual carefully before using the product. After reading them, be sure to keep them for future reference.

Contents

Getting started	1
Accessories	2
Features	2
Cautions on handling	4
Basic version	5
Connections	6
Important information	6
Connecting an HDMI-compatible device	9
Connecting an HDMI-incompatible device	15
Connecting a device with a multi-channel output connector.....	28
Connecting an external power amplifier	29
Connecting an external control device.....	30
Connecting to a home network (LAN)	31
Connecting the power cord	32
Setup	33
Set up speakers (Audyssey® Setup)	33
Making the network settings (Network)	40
Playback (Basic operation)	41
Important information	41
Playing a Blu-ray Disc player/DVD player	42
Playing a Blu-ray Disc player compatible with Denon Link HD	42
Playing Super Audio CD	43
Playing a CD player	43
Playing an iPod.....	44
Playing a USB memory device.....	47
Listening to HD Radio stations	50
Network contents	59
Listening to Internet Radio	59
Playing back files stored on a PC and NAS	62
Using online services.....	66
Convenient functions.....	76
AirPlay function.....	82
Selecting a listening mode (Sound Mode)	84
Selecting a listening mode.....	84

Advanced version	90
Installation/connection/setup of speakers (Advanced)	91
Speaker installation.....	91
Speaker connection	93
Set up speakers.....	99
Playback (Advanced operation)	102
HDMI control function	102
InstaPrevue function.....	104
Sleep timer function	105
Quick select function	106
REC OUT mode	107
Web control function	108
Various memory functions.....	110
Playback in ZONE2/ZONE3/ZONE4 (Separate room)	111
Audio output	111
Video output	112
Playback.....	113
Sleep timer function	113
How to make detailed settings	114
Menu map	114
Examples of menu screen displays	116
Examples of menu and front display	117
Inputting characters	118
Audio.....	120
Video.....	128
Inputs.....	134
Speakers.....	139
Network.....	146
General	150
Operating external devices with the remote control	157
Registering preset codes	157
Operating external devices	160
Operating devices.....	161
Operating learning function	163
Operating macro function	165
Specifying the zone used with the remote control unit.....	167
Setting the Remote ID.....	167
Setting the display time length of the remote control unit display.....	167
Setting the back light	168
Restoring all settings of the remote control unit to default	168

Informations	169
Part names and functions	170
Front panel.....	170
Display	172
Rear panel.....	173
Remote control unit.....	174
Other information	176
Trademark information.....	176
Relationship between the Amp Assign mode settings and audio output.....	177
Surround	184
Relationship between video signals and monitor output.....	190
Explanation of terms.....	193
Troubleshooting	196
Resetting the microprocessor	201
Specifications	202

Accessories

Check that the following parts are supplied with the product.

① Getting Started	1
② CD-ROM (Owner's manual)	1
③ Safety Instructions	1
④ Warranty (for North America model only).....	1
⑤ Service network list.....	1
⑥ Power cord	1
⑦ Remote control unit (RC-1165).....	1
⑧ LR6/AA batteries	2
⑨ AM loop antenna	1
⑩ FM indoor antenna	1
⑪ Setup microphone	1
(ACM1HB)	

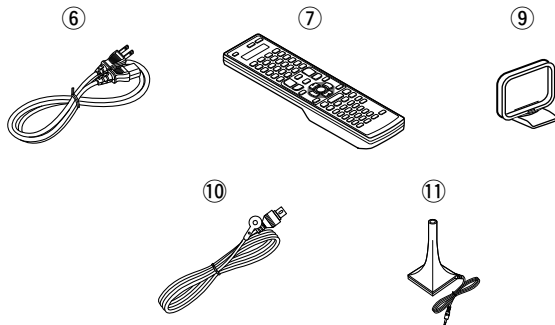

Features

Digital video processor up-scales analog video signals (SD resolution) to 4K

This unit is equipped with the 4K video upscaling function, which allows for outputting analogue or SD (standard video quality) video to HDMI at 4K (3840 × 2160 pixels). This enables the unit and a TV connected with a single HDMI cable and any video source to be reproduced precisely with HD level of quality.

DENON's unique high quality playback technology "Denon Link HD" (👉 page 42)

By connecting to a DENON Blu-ray Disc player compatible with Denon Link HD, the sound localization becomes more precise, reproducing a clear and three-dimensional sound image. Because this unit makes the integrated circuits operate while sharing the same clock with the Blu-ray Disc player, the transmitted digital audio has less jitter. This effect applies to any media audio source from the Blu-ray Disc player.

Equipped with "Hybrid PLL Jitter Reducer" capable of reducing jitter and phase noise that negatively affect sound quality

"Hybrid PLL Jitter Reducer" provided with this unit improves the sound localization, reproducing a natural sound field.

Equipped with a Multi-Zone Function 4 source, 4 zone output

This unit is equipped with a multi-zone function, so you can enjoy separate sound sources in four rooms including MAIN ZONE.

Equipped with an HDMI output for ZONE4

This unit is equipped with an HDMI output for ZONE4, which allows you to enjoy video and audio in a room in ZONE4 as well. You can enjoy video sources other than those in MAIN ZONE.

With a discrete-circuit configuration, the power amplifier provides identical quality for all 9 channels (190 W x 9ch)

The unit is equipped with a power amplifier that reproduces high-fidelity sound in sound mode with equal quality and power for all channels, true to the original sound.

The power amplifier circuit adopts a discrete-circuit configuration that achieves high-quality surround sound reproduction.

Supports Internet Radio, music, and photograph streaming

Supports AirPlay® (👉 page 82)

You can enjoy a wide variety of content, including listening to Internet Radio, playing the audio files stored on your PC, and displaying on a TV the photographs stored on your PC.

This unit also supports AirPlay that lets you stream your music library from an iPhone®, iPad®, iPod touch® or iTunes®.

Compatible with "Denon Remote App" for performing basic operations of the unit with an iPad, iPhone*1 or Android smartphone

"Denon Remote App" is application software that allows you to perform basic operations with an iPad, iPhone, Android smartphone or Android tablet such as turning the unit ON/OFF, controlling the volume, and switching the source.

*1 Download "Denon Remote App" from iTunes® App Store. The unit needs to be connected to a LAN and the iPhone/iPod touch needs to be connected to the same network by Wi-Fi (wireless LAN).

“Setup Assistant”, providing easy-to-follow setup instructions

First select the language when prompted. Then simply follow the instructions displayed on the TV screen to set up the speakers, network, etc.

Easy to use, Graphical User Interface

This unit is equipped with an easy to see “Graphical User Interface” that uses menu displays and levels. The use of level displays increases operability of the this unit.

HDMI connectors enable connection to various digital AV devices (input: 7, output: 3)

The unit is equipped with 7 HDMI input connectors for connecting devices with HDMI connectors, such as a Blu-ray Disc player, game machine, HD digital camcorder, etc.

Supports HDMI (3D, ARC, Deep Color, “x.v.Color”, Auto Lip Sync, 4K) and HDMI control function (page 9)

In addition to HDMI 3D and ARC (Audio Return Channel) functions, this unit supports the video pass-through function, which outputs video to TV without changing the video quality when video signals of 4K (3840×2160 pixels) are input, and the GUI overlay function, which overlays the menu screen (GUI) on the 4K video screen.

Simultaneous playback on two HDMI channels (for MAIN ZONE)

This unit is equipped with two HDMI MONITOR outputs. You can connect one output to a projector and the other output to a TV for simultaneous signal outputs.

Direct play for iPod and iPhone via USB

(page 23)

Music data from an iPod can be played back if you connect the USB cable supplied with the iPod via the iPod/USB port of this unit, and also an iPod can be controlled with the remote control unit for this unit.

Audyssey DSX®

This unit is equipped with Audyssey DSX® processor. By connecting front height speakers to this unit and playing back through Audyssey DSX®, you can experience a more powerful playback expression in the height audio range. By connecting front wide speakers, you can experience a more powerful playback expression in the wide audio range.

DTS Neo:X

This technology enables the playback of 2-channel source audio or 7.1/5.1 multi-channel source audio through a maximum 11.1 channel speakers, achieving an even broader sound field.

Audyssey LFC™ (Low Frequency Containment)

Audyssey LFC™ solves the problem of low frequency sounds disturbing people in neighboring rooms or apartments. Audyssey LFC™ dynamically monitors the audio content and removes the low frequencies that pass through walls, floors and ceilings. It then applies psychoacoustic processing to restore the perception of low bass for listeners in the room. The result is great sound that no longer disturbs the neighbors.

Discrete subwoofers and Audyssey Sub EQ HT™

The unit has two subwoofer output capability and can adjust the level and delay for each subwoofer individually. Audyssey Sub EQ HT makes the integration seamless by first compensating for any level and delay differences between the two subwoofers and then applying Audyssey MultEQ® XT 32 to both subwoofers together.

InstaPrevue Technology

Live picture-in-picture preview of HDMI input connected to an AV receiver.

MHL (Mobile High-Definition Link) function

You can charge your mobile device that supports MHL by providing power from this unit while outputting video from that mobile device. You can also control mobile devices that support MHL through this unit.

Cautions on handling

- **Before turning the power on**

Check once again that all connections are correct and that there are no problems with the connection cables.

- Power is supplied to some of the circuitry even when the unit is set to the standby mode. When going on vacation or leaving home for long periods of time, be sure to unplug the power cord from the power outlet.

- **About condensation**

If there is a major difference in temperature between the inside of the unit and the surroundings, condensation (dew) may form on the operating parts inside the unit, causing the unit not to operate properly.

If this happens, let the unit sit for an hour or two with the power turned off and wait until there is little difference in temperature before using the unit.

- **Cautions on using mobile phones**

Using a mobile phone near this unit may result in noise. If that occurs, move the mobile phone away from this unit when it is in use.

- **Moving the unit**





Turn off the power and unplug the power cord from the power outlet. Next, disconnect the connection cables to other system units before moving the unit.

- **About care**

- Wipe the cabinet and control panel clean with a soft cloth.
- Follow the instructions when using a chemical cleaner.
- Benzene, paint thinner or other organic solvents as well as insecticide may cause material changes and discoloration if brought into contact with the unit, and should therefore not be used.

Basic version

Here, we explain the connections and basic operation methods for this unit.

- **Connections**  [page 6](#)
- **Setup**  [page 33](#)
- **Playback (Basic operation)**  [page 41](#)
- **Network contents**  [page 59](#)
- **Selecting a listening mode (Sound Mode)**  [page 84](#)

Connections

Important information

Make connections before using this unit.

To create a home theater that can play back higher quality video and audio by fully utilizing the capabilities of this unit and your video devices, connect this unit to each of your video devices with HDMI cables.

❑ HDMI-compatible device

If your video device does not support HDMI connections, use the following connection.

❑ HDMI-incompatible device

This unit can change the source that is assigned to the DIGITAL AUDIO IN, ANALOG AUDIO IN, COMPONENT VIDEO IN and VIDEO IN connectors.

For details on assigning a source to connectors, see “Changing the source assigned to connectors” (👉 [page 15](#)). For the setting method, see “Input Assign” (👉 [page 135](#)).

NOTE

- While signals are being upscaled to 4K, the menu screen is only displayed on a TV that is connected to this unit via HDMI.
- Do not plug in the power cord until all connections have been completed. However, when the “Setup Assistant” is running, follow the instructions in the “Setup Assistant” (📖 [page 7](#)) screen for making connections. (During “Setup Assistant” operation, the input/output connectors do not conduct current.)
- When running the “Setup Assistant” (📖 [page 7](#)), turn off the power supply of connected devices.
- When making connections, also refer to the operating instructions of the other devices being connected.
- Be sure to connect the left and right channels properly (left with left, right with right).
- Do not bundle power cords together with connection cables. Doing so can result in noise.

❑ HDMI-compatible device



👉 [page 10](#)



👉 [page 12](#)



👉 [page 12](#)



👉 [page 12](#)



👉 [page 12](#)



👉 [page 12](#)



👉 [page 12](#)

❑ HDMI-incompatible device



👉 [page 16](#)



👉 [page 17](#)



👉 [page 18](#)



👉 [page 19](#)



👉 [page 20](#)



👉 [page 21](#)



👉 [page 22](#)



👉 [page 23](#)



👉 [page 25](#)



👉 [page 26](#)



👉 [page 27](#)



👉 [page 31](#)

❑ Others



👉 [page 93](#)



👉 [page 32](#)

Converting input video signals for output (Video conversion function)

This unit is equipped with three types of video input connectors (HDMI, Component video and video) and three types of video output connectors (HDMI, Component video and video).

This function automatically converts various formats of video signals input to this unit into the formats used to output the video signals from this unit to a monitor.

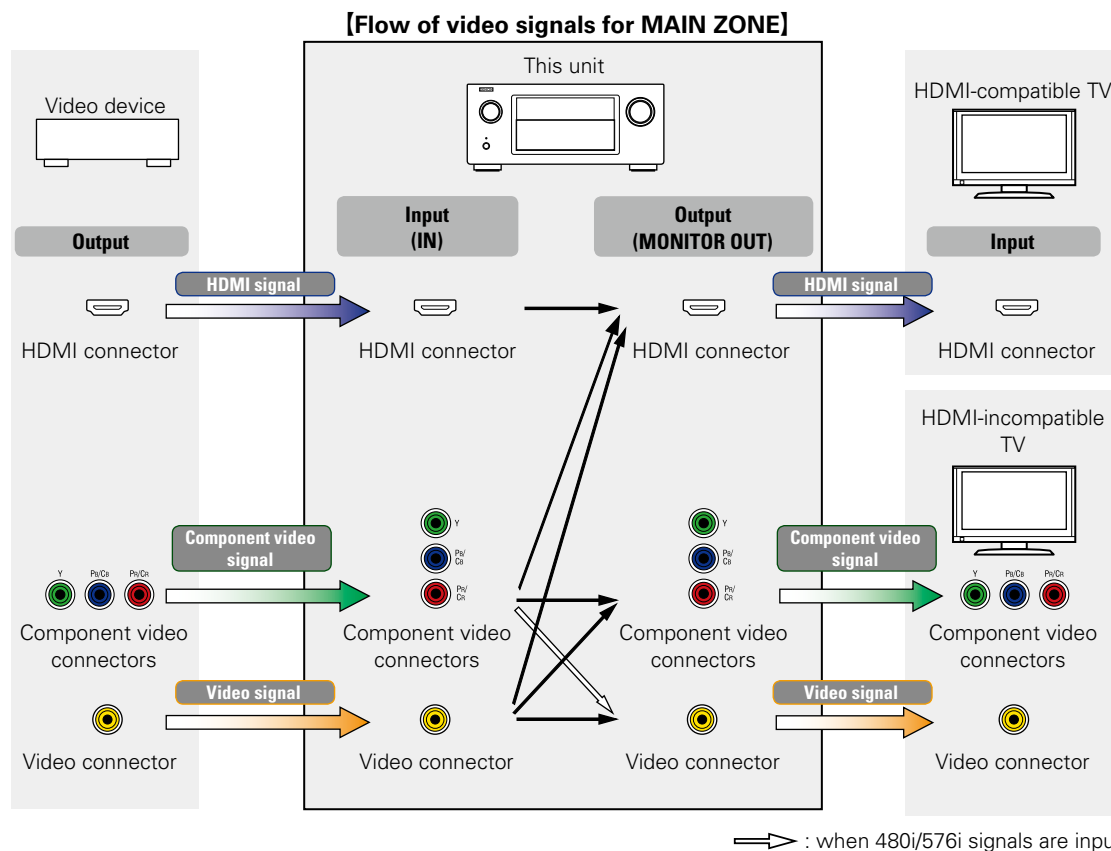

For example, when an HDMI-compatible TV is connected to this unit with an HDMI cable, input signals other than HDMI video signals are automatically converted to HDMI signals that are then output from the HDMI connector to the TV. Only one type of video signals is output, so video signals output from this unit to the TV do not change even when the source for playback is switched to a device that outputs video signals in a different format, which allows you to continue with playback without the need to switch the video input source on the TV. Furthermore, the video quality improves because analog video signals such as video and component video signals that are input to this unit are converted to digital HDMI video signals with a higher resolution for output. When a TV does not support the HDMI connection, make an analog connection between this unit and the TV for video signals. This unit cannot convert HDMI input signals to analog video signals, so when signals are input from an HDMI device, use the component video input connector or video input connector. In this case, the component video signals that are input to this unit are converted to video signals.

Make Settings as Necessary

- If you do not want this unit to convert video signals automatically, use the following setting item to disable this function.
"Video Conversion" (🔗 [page 131](#))
- If you want to change the resolution of video signals output to the TV, use the following setting item to do so.
"Resolution" (🔗 [page 132](#))



- The video conversion function supports the NTSC, PAL, SECAM, NTSC 4.43, PAL-N, PAL-M and PAL-60 formats.
- Resolutions of HDMI-compatible TVs can be checked at "Video" – "HDMI Monitor 1" or "HDMI Monitor 2" (🔗 [page 153](#)).

NOTE

- **While signals are being upscaled to 4K, the menu screen is only displayed on a TV that is connected to this unit via HDMI.**
- When a non-standard video signal from a game machine or some other source is input, the video conversion function might not operate.

[Flow of video signals for ZONE4]

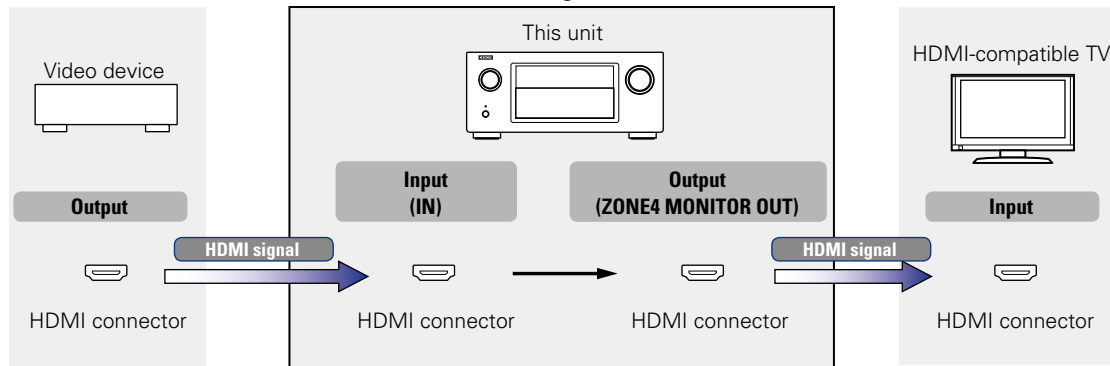

[Flow of video signals for ZONE2]

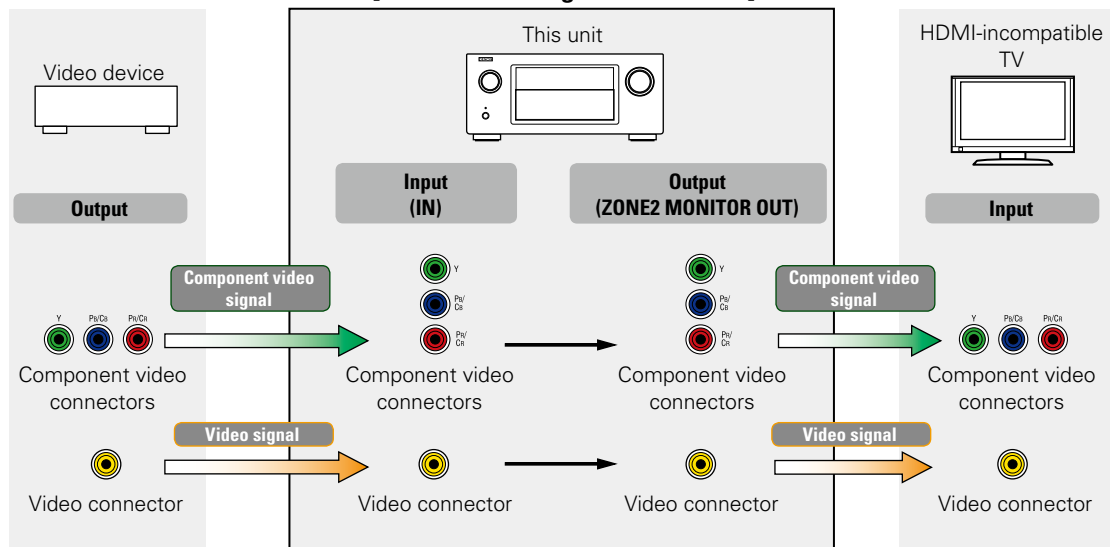

NOTE

- HDMI signals are digital. HDMI signals cannot be converted into analog signals.
- The HDMI ZONE4 function is only compatible with the HDMI 1 – 6 IN connectors. It is not compatible with the HDMI 7 IN connector.

Connecting an HDMI-compatible device

You can connect up to ten HDMI-compatible devices (7-inputs/3-outputs) to the unit.

When a TV is connected to the HDMI ZONE4 OUT connector, you can play back a video or audio from the device connected to the HDMI 1 – 6 IN connector in ZONE4 ([page 111](#)).

If the device connected to this unit is equipped with an HDMI connector, it is recommended to use HDMI connections. Connections with an HDMI cable offer the following benefits that can not be achieved with other connection methods.

- **High quality playback by transmitting audio and video via digital signals**

HDMI connections can transmit high definition video and high quality audio formats adopted by Blu-ray disc players (Dolby Digital Plus, Dolby TrueHD, dts-HD, dts-HD Master Audio).

HDMI connections also convey information required for playback between devices. The information is used for copyright protection and TV resolution recognition, the ARC function, the HDMI control function, etc.

- **Transmission of audio and video signals with a single HDMI cable**

Previous connections require multiple audio and video cables, but HDMI connections require only a single HDMI cable to transmit audio and video signals. This allows wires in a home theater system, which tend to be complicated, to be more organized.

- **Mutual control through the HDMI control function ([page 102](#))**

This unit and the HDMI device connected via HDMI can be linked to perform operations such as power control, volume control, and input source switching.

- **Other video and audio functions, such as 3D video playback, Content Type, the ARC function, are supported ([page 13](#)).**



- There is more than one version of HDMI standard. The supported functions and the performance vary according to the version. This unit complies with the HDMI standard, supporting the ARC and 3D playback functions. To enjoy these functions, the HDMI device connected to this unit also needs to use the same version of the standard. For the version of the HDMI standard on the device connected to this unit, see the device's manual.
- Some TVs do not support audio input via HDMI connections. For details, see your TV's manual.

❑ **Before connecting this unit to TV via HDMI connections** ([page 10](#))

❑ **Connecting this unit to a TV via HDMI connections** ([page 11](#))

❑ **Connecting this unit to video devices via HDMI connections** ([page 12](#))

❑ **HDMI function** ([page 13](#))

❑ **Settings related to HDMI connections** ([page 14](#))

Before connecting this unit to TV via HDMI connections

There are 2 methods to connect HDMI-compatible TV to this unit.
Use the connection method that suits your TV.

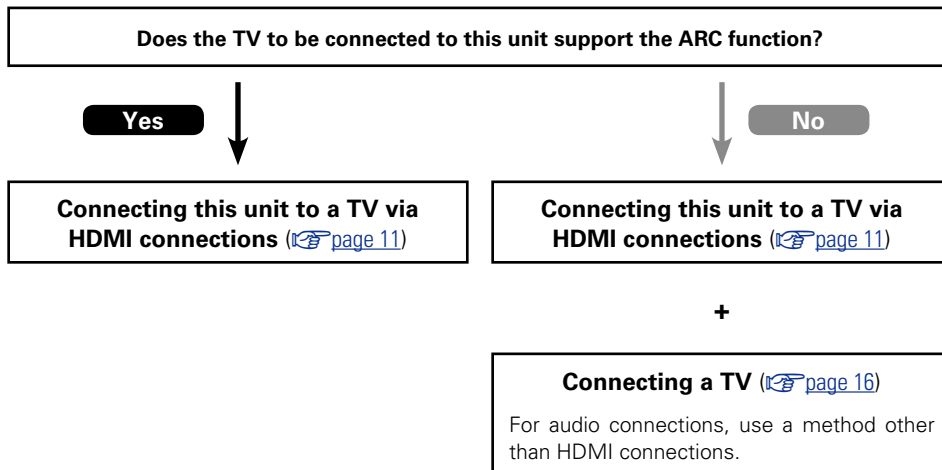

About ARC (Audio Return Channel) function

This function plays TV audio on this unit by sending the TV audio signal to this unit via HDMI cable. If a TV without the ARC function is connected via HDMI connections, video signals of the playback device connected to this unit are transmitted to the TV, but this unit can not play back the audio from the TV. If you want to enjoy surround audio for TV program, a separate audio cable connection is required.

In contrast, if a TV with the ARC function is connected via HDMI connections, no audio cable connection is required. Audio signals from the TV can be input to this unit through the HDMI cable between this unit and the TV. This function allows you to enjoy surround playback on this unit for the TV.



When the ARC function is used, connect a device with a "Standard HDMI cable with Ethernet" or "High Speed HDMI cable with Ethernet" for HDMI. Refer to the owner's manual for your TV for details about TV connection and settings.

NOTE

The HDMI ZONE4 OUT connector is not compatible with the ARC function.

[Connection to a TV with the ARC function]

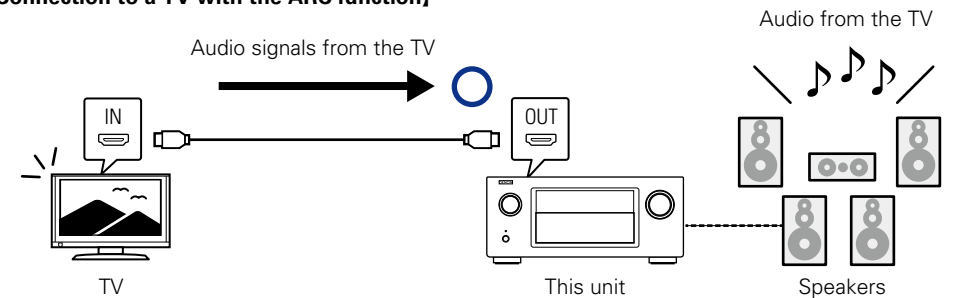

[Connection to a TV without the ARC function]

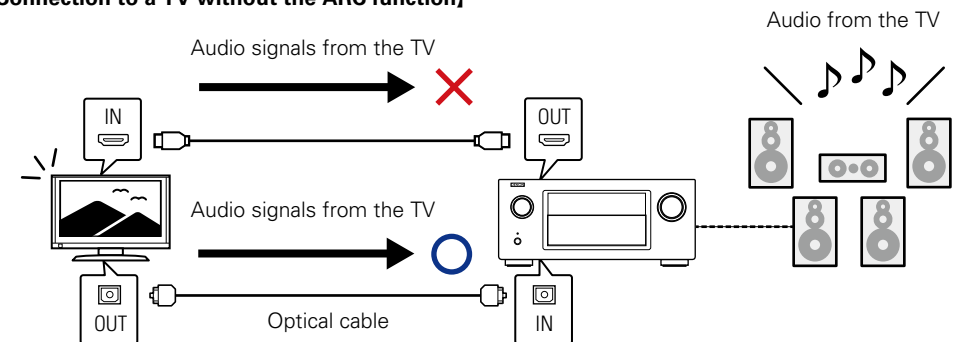

Connecting this unit to a TV via HDMI connections

When a TV is connected to the HDMI ZONE4 OUT connector, you can play back a video or audio from the device connected to the HDMI 1 – 6 IN connector in ZONE4 ([page 111](#)).

Cables used for connections

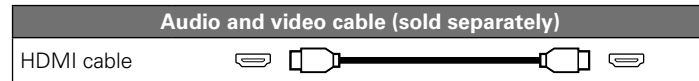

- This interface allows transfer of digital video signals and digital audio signals over a single HDMI cable.

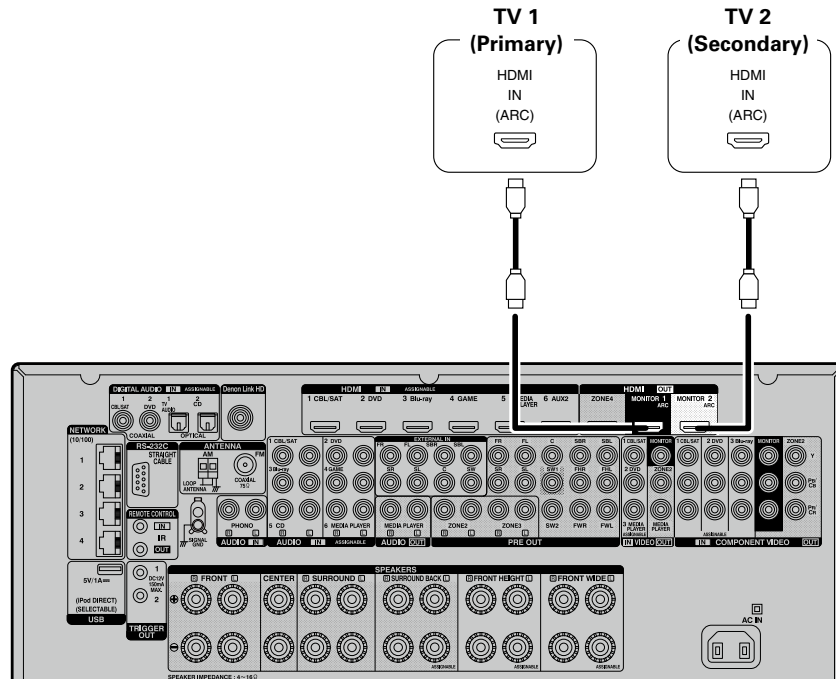

- Video signals are not output if the input video signals do not match the monitor's resolution. In this case, switch the Blu-ray Disc/DVD player's resolution to a resolution with which the monitor is compatible.
- When this unit and monitors are connected with an HDMI cable, if the monitor is not compatible with HDMI audio signal playback, only the video signals are output to the monitor. Make audio connections ([page 16](#) "Connecting a TV").

NOTE

- The HDMI 7 / MHL connector on the front panel does not support the HDMI ZONE4 function.
- The audio signal from the HDMI output connector (sampling frequency, number of channels, etc.) may be limited by the HDMI audio specifications of the connected device regarding permissible inputs.
- When connecting a TV that does not support the ARC function, an audio cable connection is required in addition to the HDMI cable. In this case, refer to "Connecting a TV" ([page 16](#)) for the connection method.**
- For the ARC function, see "About ARC (Audio Return Channel) function" ([page 10](#)).**

Connecting to a device equipped with a DVI-D connector

The DVI-D (Digital Visual Interface) method is also used for video transmission via digital signals. This is developed mainly for computers, and some AV devices such as projectors are equipped with this interface. To output HDMI video signals to a DVI-D video input compatible device, use an HDMI/DVI conversion cable, which converts HDMI video signals to DVI signals. The DVI-D connector can transmit high quality digital signals, but the copy guard and other issues may hinder normal operations for some device combinations.

NOTE

- No sound is output when connected to a device equipped with a DVI-D connector. Make audio connections as described in "Connecting a TV" ([page 16](#)).
- Signals cannot be output to DVI-D devices that do not support HDCP.
- Depending on the combination of devices, the video signals may not be output.

Settings required when using a TV that supports the ARC function

When using a TV that supports the ARC function, make the following settings.

- Set "HDMI Control" ([page 130](#)) to "On".
- Set "Control Monitor" ([page 130](#)) to match the number of the HDMI MONITOR connector connected to the TV that supports the ARC function.

NOTE

If the TV that supports the ARC function is connected to both HDMI MONITOR 1 and HDMI MONITOR 2 connectors, you cannot use ARC function at the same time.

Connecting this unit to video devices via HDMI connections

Cables used for connections

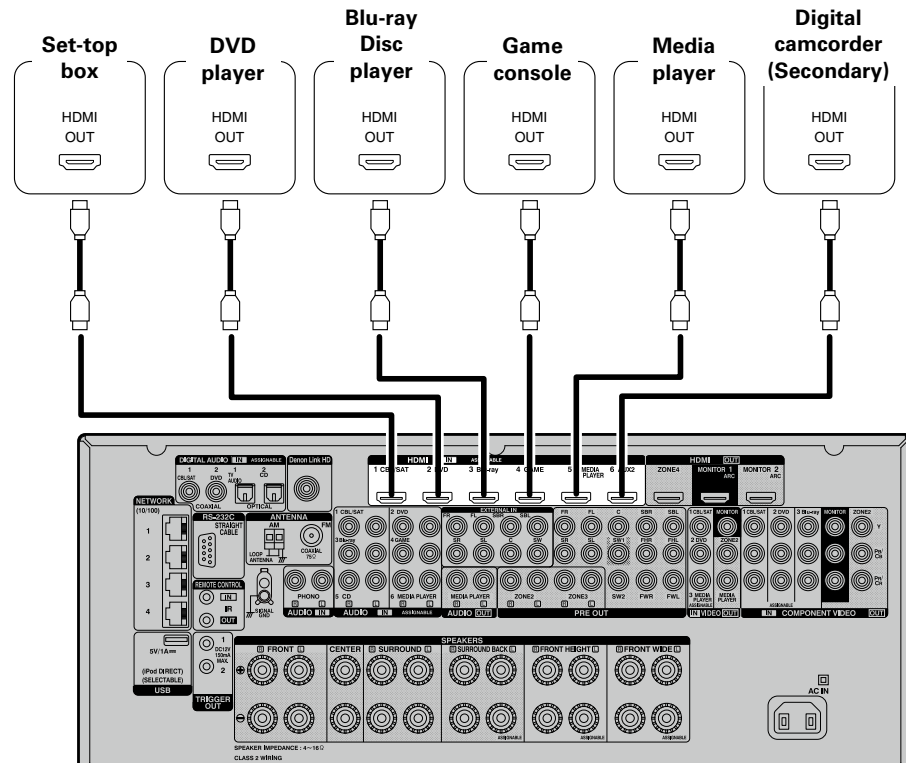
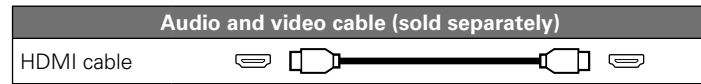

[Rear panel]

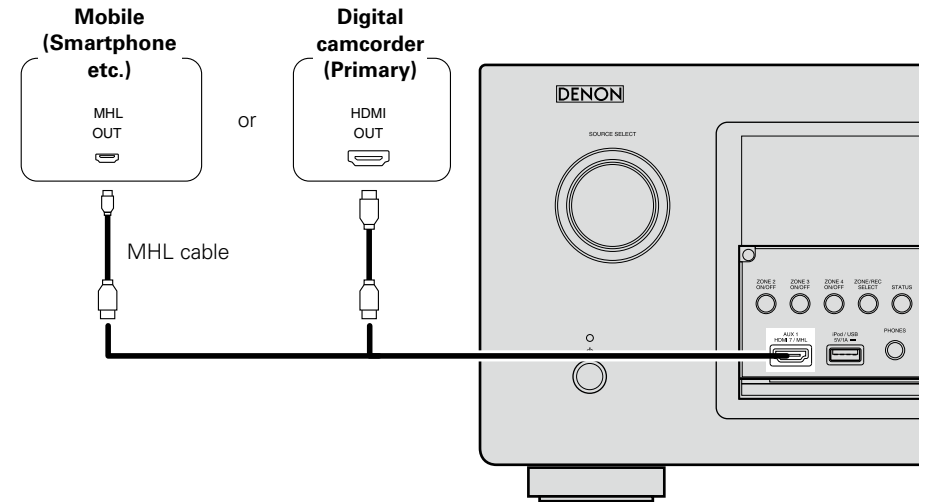

[Front panel]



- Connect Mobile (Smartphone etc.) to the HDMI 7 / MHL connector on the front panel.
- When this unit is connected to other devices with HDMI cables, connect this unit and TV also with an HDMI cable.
- When connecting a device that supports Deep Color or 4K, please use a “High Speed HDMI cable” or “High Speed HDMI cable with Ethernet”.
- Video signals are not output if the input video signals do not match the monitor’s resolution. In this case, switch the Blu-ray Disc/DVD player’s resolution to a resolution with which the monitor is compatible.

NOTE

- The HDMI 7 / MHL connector on the front panel does not support the HDMI ZONE4 function.
- The HDMI 7 / MHL connector on the front panel does not support the InstaPrevue function.
- The HDMI 7 / MHL connector on the front panel does not support the 4K.

Connecting a player compatible with the Denon Link HD function

By making a Denon Link HD connection to a player compatible with the Denon Link HD function, you can enjoy higher quality playback compared with when only the HDMI connector connection is made. For the playback method, see “Playing a Blu-ray Disc player compatible with Denon Link HD” (page 42).

When making this connection, set “Input Assign” – “DIGITAL” (page 136) to “D.LINK”.

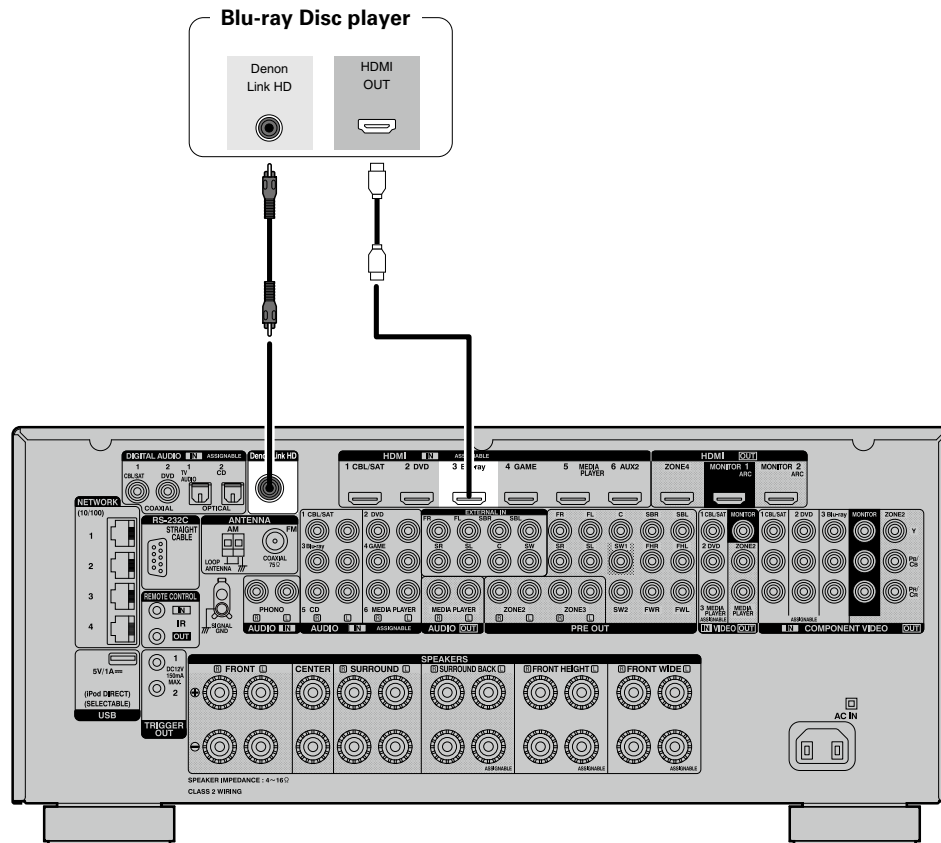

NOTE

The Denon Link HD connector is not an audio signal input connector. Audio signals cannot be played back only by making a connection with the Denon Link HD connector.

HDMI function

This unit supports the following HDMI functions:

About 3D function

This unit supports input and output of 3D (3 dimensional) video signals of HDMI.

To play back 3D video, you need a TV and player that provide support for the HDMI 3D function and a pair of 3D glasses.

NOTE

- When playing back 3D video, refer to the instructions provided in the manual of your playback device together with this manual.
- When playing back 3D video content, the menu screen or status display screen can be superimposed over the image. However, the menu screen or status display screen cannot be superimposed over certain 3D video content.
- If 3D video with no 3D information is input, the menu screen and status display on this unit are displayed over the playback video.
- If 2D video is converted to 3D video on the television, the menu screen and status display on this unit are not displayed correctly. To view the menu screen and status display on this unit correctly, turn the television setting that converts 2D video to 3D video off.

About 4K function

This unit supports input and output of 4K (3840 x 2160 pixels) video signals of HDMI.



When a device supporting 4K is connected, use a cable compatible with “High Speed HDMI cable” or “High Speed HDMI cable with Ethernet”.

HDMI pass through function (page 130)

Signals input to the HDMI input connector are output to the television or other device connected to the HDMI output connector, even if the power of this unit is in standby.

HDMI control function (👉 [page 102](#))

This function allows you to operate external devices from the unit and operate the unit from external devices.

NOTE

- The HDMI control function may not work depending on the device it is connected to and its settings.
- You cannot operate a TV or Blu-ray Disc player/DVD player that is not compatible with the HDMI control function.
- The HDMI ZONE4 function is compatible with the HDMI control function. To enable the HDMI control for the ZONE4 HDMI monitor, set "Control Monitor" (👉 [page 130](#)) to "ZONE4".

About Content Type

This function was added with the HDMI standard. It automatically makes settings suitable for the video-output type (content information).

NOTE

To enable the Content Type, set "Video Mode" to "Auto" (👉 [page 131](#)).

Deep Color (👉 [page 193](#))

When a device supporting Deep Color is connected, use a cable compatible with "High Speed HDMI cable" or "High Speed HDMI cable with Ethernet".

Auto Lip Sync (👉 [page 129](#), [193](#))**"x.v.Color", sYCC601 color, Adobe RGB color, Adobe YCC601 color** (👉 [page 193](#), [195](#))**High definition digital audio format****ARC (Audio Return Channel)** (👉 [page 10](#))**Copyright protection system**

In order to play back digital video and audio such as BD-Video or DVD-Video via HDMI connection, both this unit and TV or the player need to support the copyright protection system known as HDCP (High-bandwidth Digital Content Protection System). HDCP is copyright protection technology comprised of data encryption and authentication of the connected AV devices. This unit supports HDCP.

- If a device that does not support HDCP is connected, video and audio are not output correctly. Read the owner's manual of your television or player for more information.

Settings related to HDMI connections

Set as necessary. For details, see the respective reference pages.

HDMI Setup (👉 [page 129](#))

Make settings for HDMI video/audio output.

- | | | |
|------------------|---------------------|-----------------------|
| • Auto Lip Sync | • Vertical Stretch | • Pass Through Source |
| • HDMI Audio Out | • HDMI Pass Through | • Control Monitor* |
| • Video Output | • HDMI Control* | • Power Off Control |

* Only these items are supported for HDMI ZONE4.

NOTE

To output audio signals that are input from the HDMI input connector to a TV connected via HDMI, set "HDMI Audio Out" (👉 [page 129](#)) to "TV".

Audio signals input via the Analog/Coaxial/Optical input connectors cannot be output from the HDMI MONITOR output connector.

Connecting an HDMI-incompatible device







For high quality video and surround playback, it is recommended to use an HDMI cable to connect this unit to TV and other video devices (see [page 9](#) "Connecting an HDMI-compatible device").

This section describes connections when your device does not support HDMI connections.

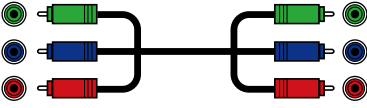
Connection methods for various devices

 TV	 page 16	 CBL/SAT	 page 17
 DVD	 page 18	 Blu-ray	 page 19
 GAME	 page 20	 AUX	 page 21
 MEDIA PLAYER	 page 22	 iPod/USB	 page 23
 CD	 page 25	 PHONO	 page 26
 TUNER	 page 27	 NETWORK	 page 31

Cables used for connections

Video cable (sold separately)	
Component video cable	
Video cable	
Audio cable (sold separately)	
Coaxial digital cable	
Optical cable	
Audio cable	
Cable (sold separately)	
Ethernet cable	

Changing the source assigned to connectors

This unit can change the source that is assigned to the HDMI IN, DIGITAL AUDIO IN, COMPONENT VIDEO IN, VIDEO IN and AUDIO IN connectors.

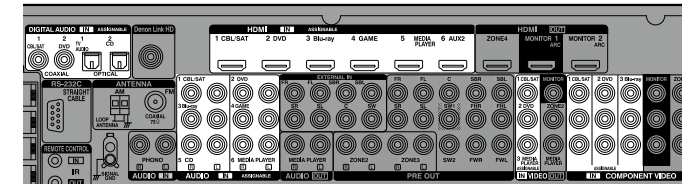

Let us take a digital audio connection for Blu-ray Disc players for an example. The rear panel digital audio input connectors do not have the input connector indication for Blu-ray disc players (Blu-ray). However, DIGITAL AUDIO IN connectors have the "ASSIGNABLE" indication, which means that you can change the source assigned to these connectors. You can assign Blu-ray disc players to these connectors to use them for Blu-ray disc players. Select "Blu-ray" when switching functions on this unit to play back the source connected to these connectors.

How to change the source assigned to connectors ([page 135](#))

Connecting a TV

- This section describes how to connect when your TV does not support HDMI connections. For instructions on HDMI connections, see “Connecting an HDMI-compatible device” ([page 9](#)).
- To listen to TV audio through this device, use the optical digital connection.



For video connections, see “Converting input video signals for output (Video conversion function)” ([page 7](#)).

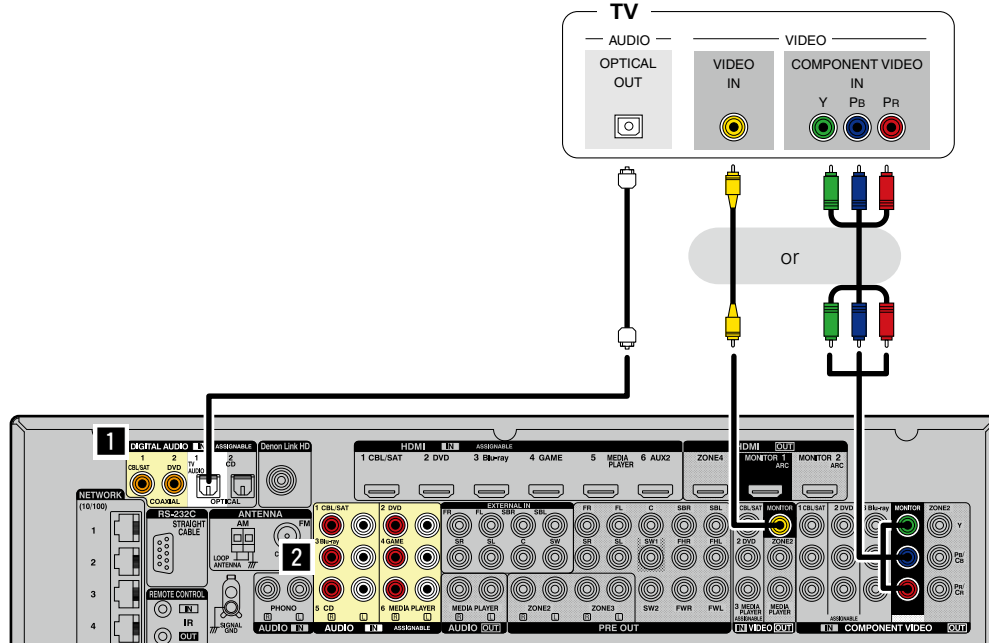

You can also make connections for the part on the connection diagram. To make connections for these connectors, you need to make the input connector settings.

To make connections for connectors indicated by **1**

Assign a connector to which an audio cable is inserted to “TV AUDIO” in “Input Assign” – “DIGITAL” ([page 136](#)).

To make connections for connectors indicated by **2**

Assign a connector to which an audio cable is inserted to “TV AUDIO” in “Input Assign” – “ANALOG” ([page 136](#)).

Connecting a set-top box (Satellite tuner/cable TV)

This section describes how to connect when your satellite tuner or cable TV does not support HDMI connections.

For instructions on HDMI connections, see “Connecting an HDMI-compatible device” ([page 9](#)).

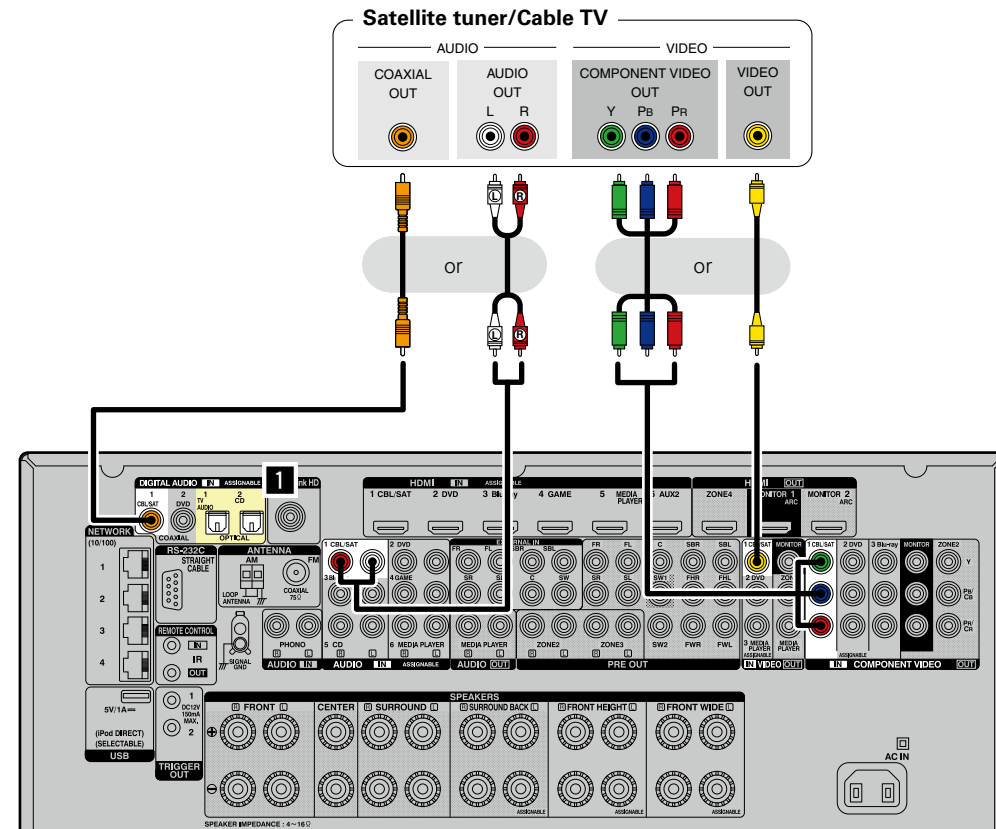

You can also make connections for the part on the connection diagram. To make connections for these connectors, you need to make the input connector settings.

To make connections for connectors indicated by 1

Assign a connector to which an audio cable is inserted to “CBL/SAT” in “Input Assign” – “DIGITAL” ([page 136](#)).

Connecting a DVD player

This section describes how to connect when your DVD player does not support HDMI connections. For instructions on HDMI connections, see "Connecting an HDMI-compatible device" ([page 9](#)).

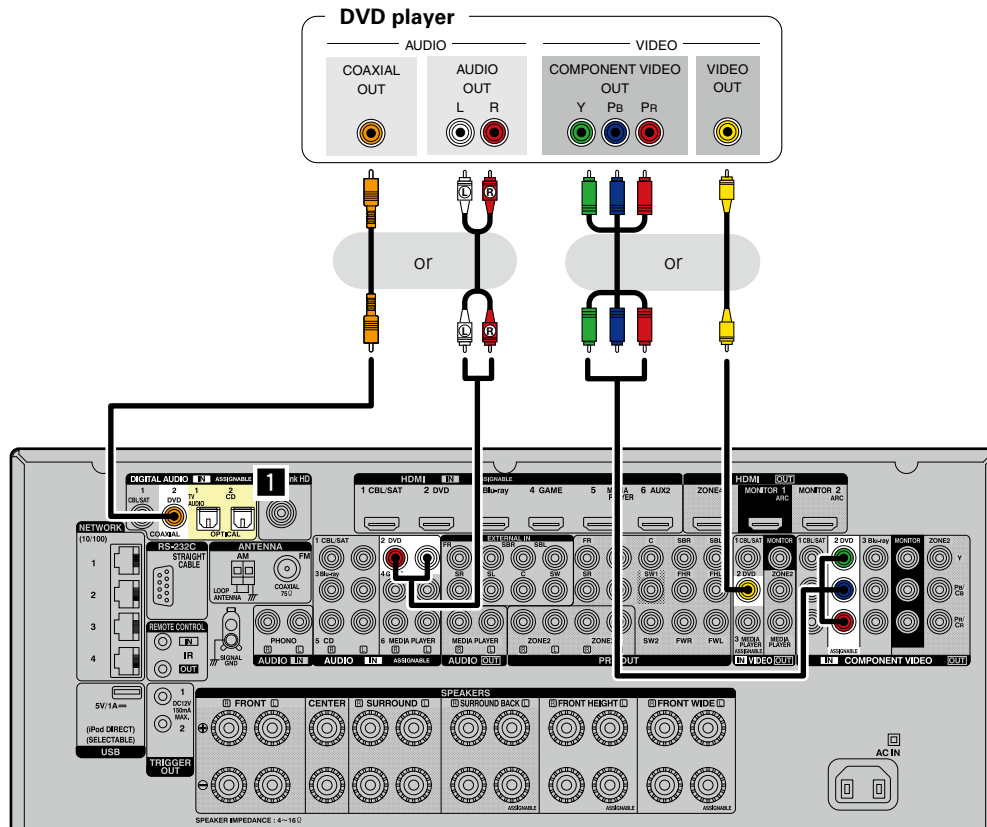

You can also make connections for the part on the connection diagram. To make connections for these connectors, you need to make the input connector settings.

To make connections for connectors indicated by 1

Assign a connector to which an audio cable is inserted to "DVD" in "Input Assign" – "DIGITAL" ([page 136](#)).

Connecting a Blu-ray Disc player

This section describes how to connect when your Blu-ray disc player does not support HDMI connections. For instructions on HDMI connections, see “Connecting an HDMI-compatible device” ([page 9](#)).

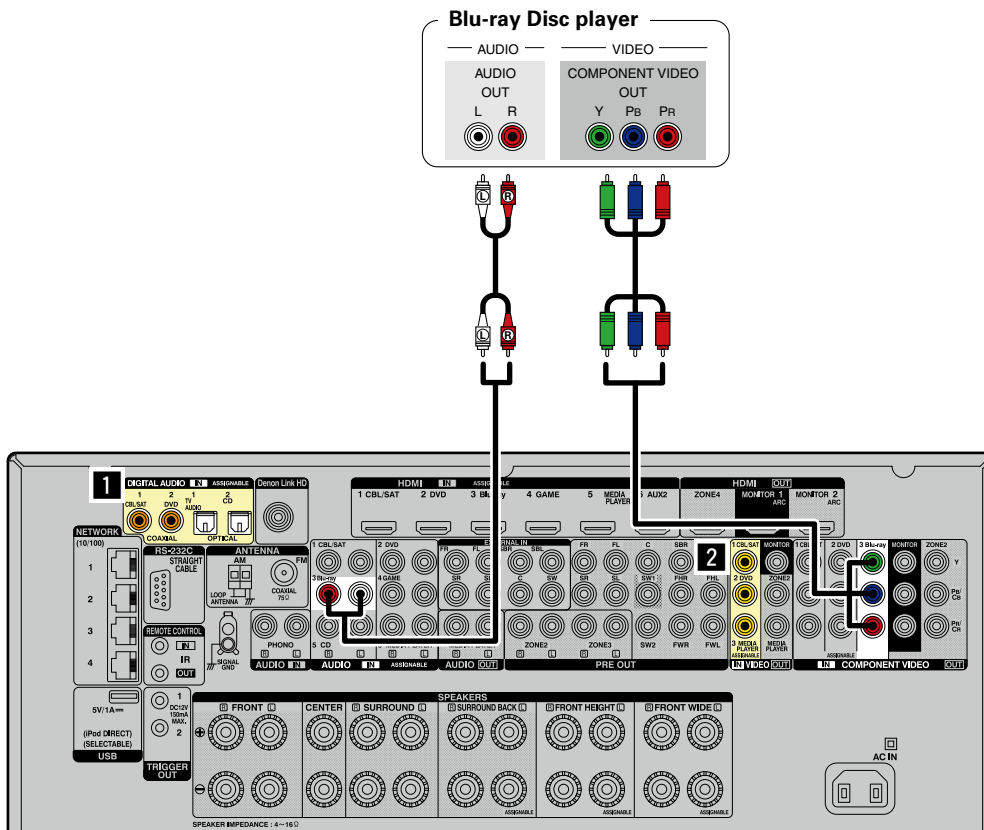

When you want to play back HD Audio (Dolby TrueHD, DTS-HD, Dolby Digital Plus, DTS Express) and Multi-channel PCM with this unit, use an HDMI connection ([page 9](#) “Connecting an HDMI-compatible device”).

You can also make connections for the part on the connection diagram. To make connections for these connectors, you need to make the input connector settings.

To make connections for connectors indicated by **1**

Assign a connector to which an audio cable is inserted to “Blu-ray” in “Input Assign” – “DIGITAL” ([page 136](#)).

To make connections for connectors indicated by **2**

Assign a connector to which a video cable is inserted to “Blu-ray” in “Input Assign” – “VIDEO” ([page 136](#)).

Connecting a game console

This section describes how to connect when your game console does not support HDMI connections. For instructions on HDMI connections, see “Connecting an HDMI-compatible device” ([page 9](#)).

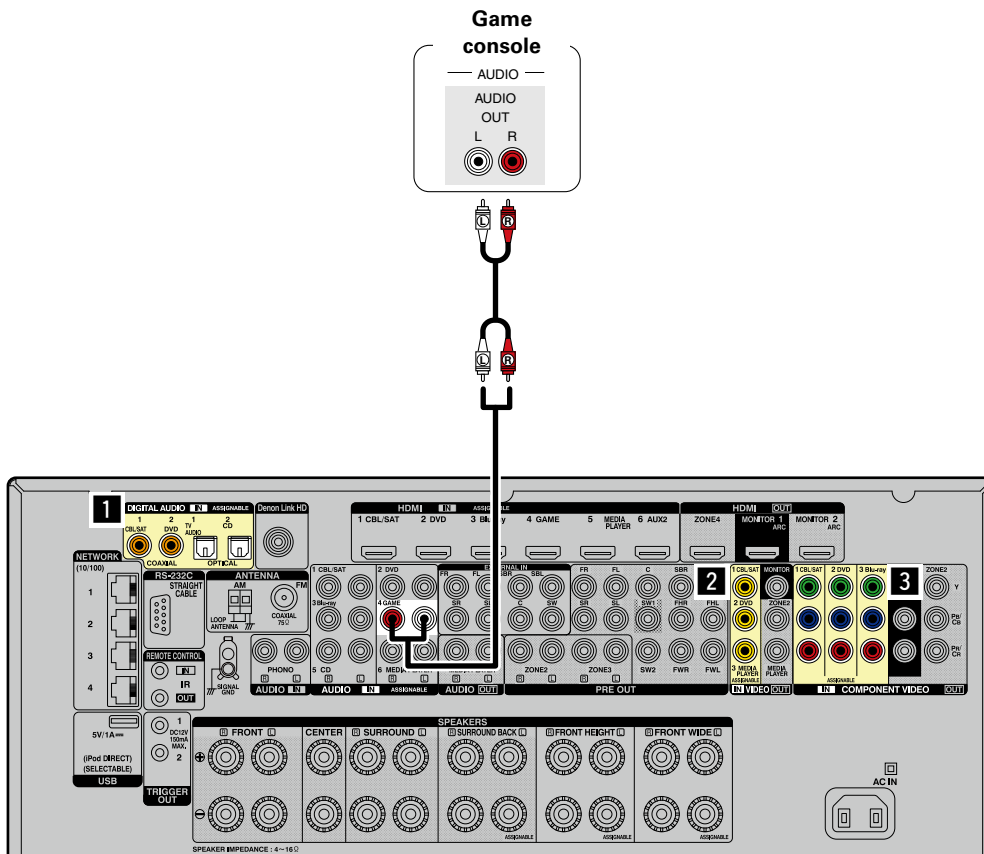

You can also make connections for the part on the connection diagram. To make connections for these connectors, you need to make the input connector settings.

To make connections for connectors indicated by **1**

Assign a connector to which an audio cable is inserted to “GAME” in “Input Assign” – “DIGITAL” ([page 136](#)).

To make connections for connectors indicated by **2**

Assign a connector to which a video cable is inserted to “GAME” in “Input Assign” – “VIDEO” ([page 136](#)).

To make connections for connectors indicated by **3**

Assign a connector to which a video cable is inserted to “GAME” in “Input Assign” – “COMP” ([page 136](#)).

Connecting a digital camcorder

This section describes how to connect when your digital camcorder does not support HDMI connections. For instructions on HDMI connections, see “Connecting an HDMI-compatible device” ([page 9](#)).

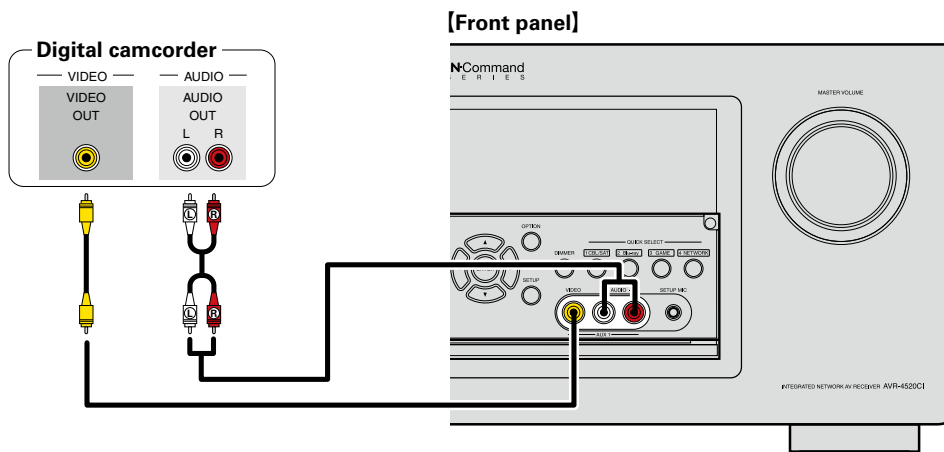

You can also make connections for the part on the connection diagram. To make connections for these connectors, you need to make the input connector settings.

To make connections for connectors indicated by **1**

Assign a connector to which an audio cable is inserted to “AUX1” in “Input Assign” – “DIGITAL” ([page 136](#)).

To make connections for connectors indicated by **2**

Assign a connector to which a video cable is inserted to “AUX1” in “Input Assign” – “COMP” ([page 136](#)).

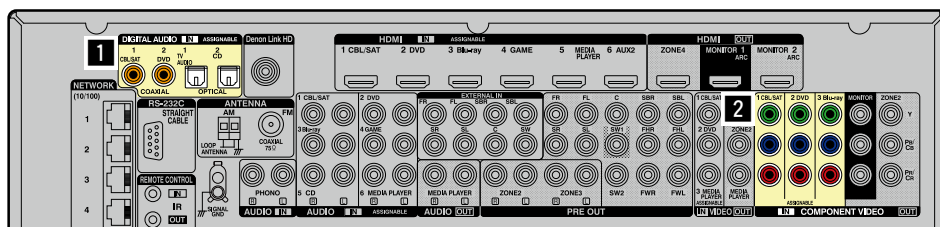

[Rear panel]



You can enjoy games by connecting a game machine via the AUX1 input connector. In this case, select the input source to “AUX1”.

NOTE

When a non-standard video signal from a game machine or some other source is input, the video conversion function ([page 7](#)) might not operate. In this case, use the monitor output of the same connector as the input.

Connecting a media player

- This section describes how to connect when your media player does not support HDMI connections. For instructions on HDMI connections, see “Connecting an HDMI-compatible device” ([page 9](#)).
- When recording analog audio, use the analog connection.
- See “REC OUT mode” ([page 107](#)) for operating instructions.

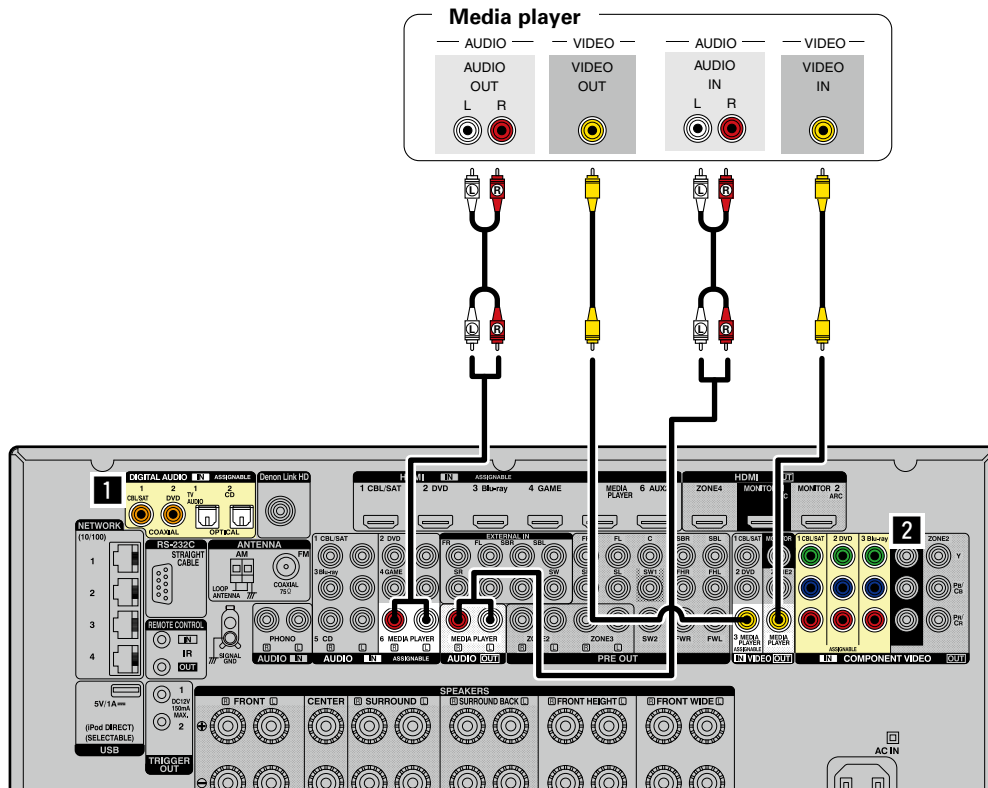

You can also make connections for the part on the connection diagram. To make connections for these connectors, you need to make the input connector settings.

To make connections for connectors indicated by **1**

Assign a connector to which an audio cable is inserted to “MEDIA PLAYER” in “Input Assign” – “DIGITAL” ([page 136](#)).

To make connections for connectors indicated by **2**

Assign a connector to which a video cable is inserted to “MEDIA PLAYER” in “Input Assign” – “COMP” ([page 136](#)).

NOTE

To record video signals through this unit, use the video cable for connection between this unit and the player.

Connecting an iPod or USB memory device to the iPod/USB port

- You can enjoy music stored on an iPod or USB memory device.
- For operating instructions see “Playing an iPod” ([page 44](#)) or “Playing a USB memory device” ([page 47](#)).



DENON does not guarantee that all USB memory devices will operate or receive power. When using a portable USB connection type HDD of the kind to which an AC adapter can be connected to supply power, use the AC adapter.

NOTE

- You cannot use the USB ports on the front panel and rear panel simultaneously.** Select and connect the USB port to use ([page 76](#)).
- USB memory devices will not work via a USB hub.
- It is not possible to use this unit by connecting the unit's iPod/USB port to a PC via a USB cable.
- Do not use an extension cable when connecting a USB memory device. This may cause radio interference with other devices.
- When connecting an iPhone to this unit, keep the iPhone at least 20 cm away from this unit. If the iPhone is kept closer to this unit and a telephone call is received by the iPhone, noise may be output from this device.
- If the iPod is connected using an iPod cable (commercially available) that is longer than 6.6 ft (2 m), sound may not be played correctly. In this case, use a genuine iPod cable, or a cable that is shorter than 3.3 ft (1 m).

Cables used for connections

To connect an iPod to this unit, use the USB cable supplied with the iPod.

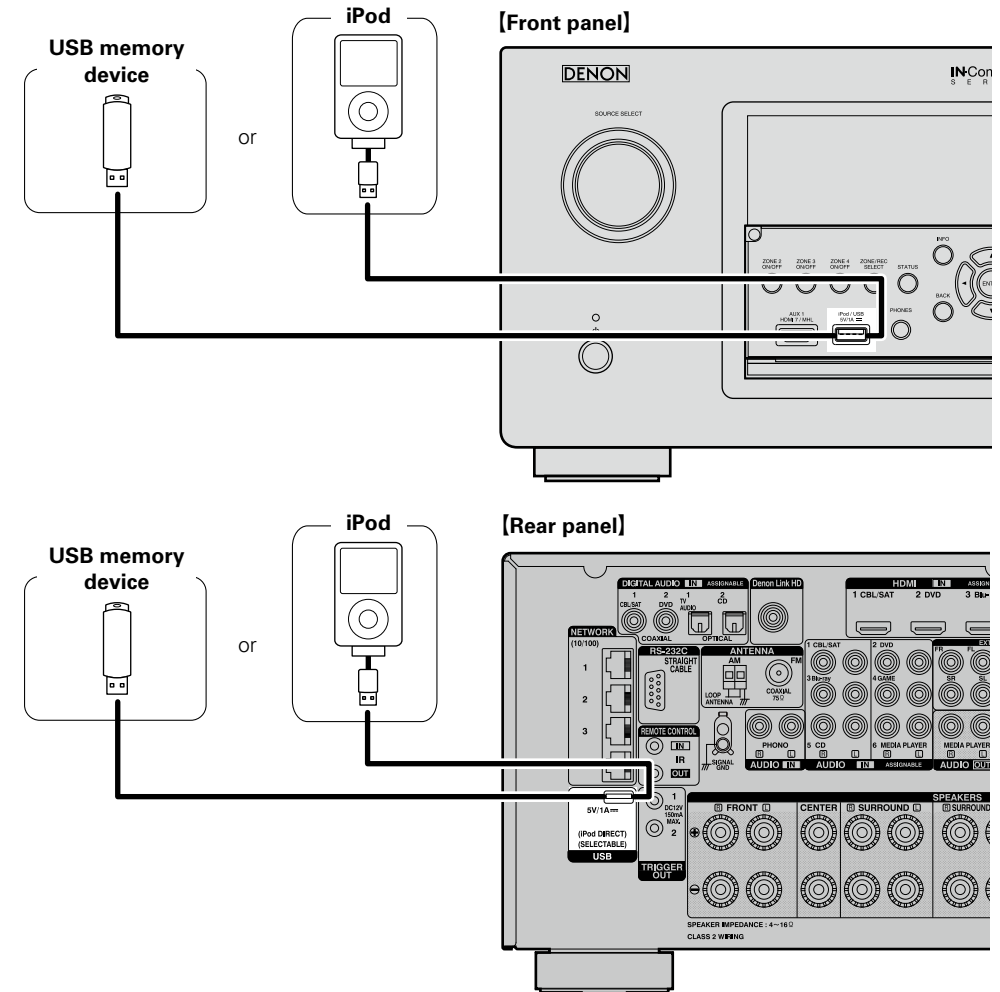

Supported iPod models

• iPod classic



iPod classic
80GB



iPod classic
160GB (2007)



iPod classic
160GB (2009)

• iPod nano



iPod nano
3rd generation
(video)
4GB 8GB



iPod nano
4th generation (video)
8GB 16GB



iPod nano
5th generation (video camera)
8GB 16GB



iPod nano
6th generation
8GB 16GB

• iPod touch



iPod touch
1st generation
8GB 16GB 32GB



iPod touch
2nd generation
8GB 16GB 32GB



iPod touch
3rd generation
32GB 64GB



iPod touch
4th generation
8GB 32GB 64GB

• iPhone



iPhone
4GB 8GB 16GB



iPhone 3G
8GB 16GB



iPhone 3GS
8GB 16GB 32GB



iPhone 4
8GB 16GB 32GB



iPhone 4S
16GB 32GB 64GB

(as of August 2012)

Connecting a CD player

You can enjoy CD sound.

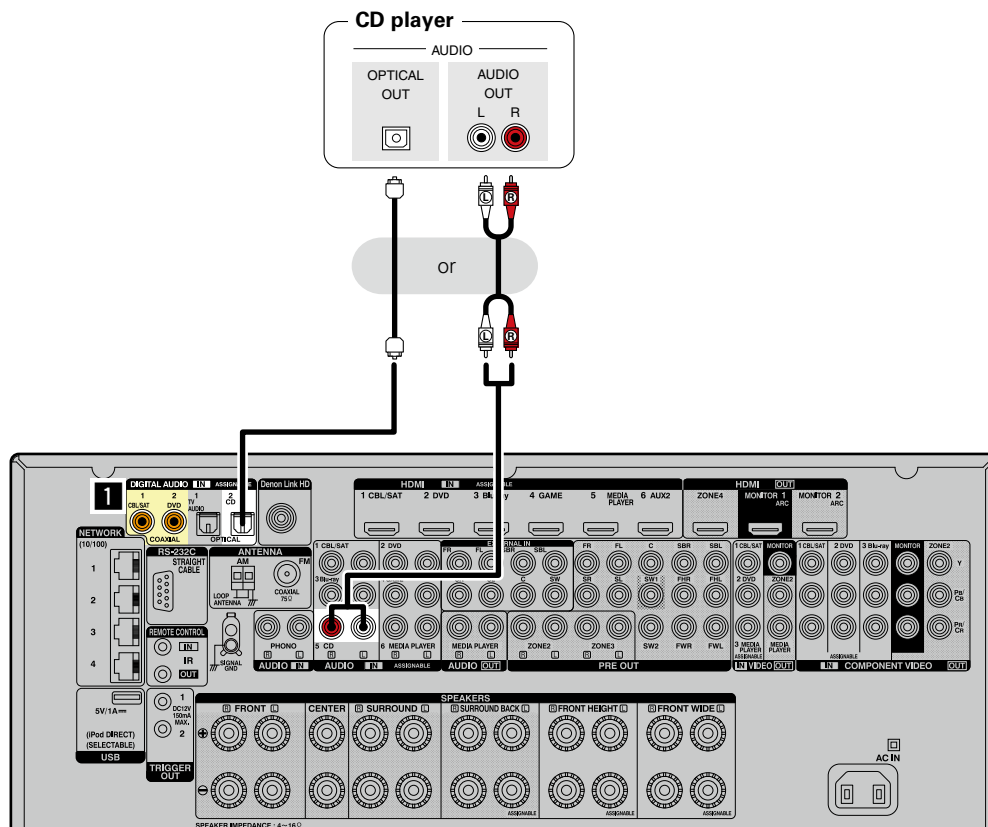

When you want to play back HD Audio (Dolby TrueHD, DTS-HD, Dolby Digital Plus, DTS Express), DSD and Multi-channel PCM with this unit, use an HDMI connection ([page 9](#) “Connecting an HDMI-compatible device”).

You can also make connections for the part on the connection diagram. To make connections for these connectors, you need to make the input connector settings.

To make connections for connectors indicated by **1**

Assign a connector to which an audio cable is inserted to “CD” in “Input Assign” – “DIGITAL” ([page 136](#)).

Connecting a record player

You can enjoy playing records.



- This unit is compatible with record players with an MM cartridge. When you connect to a record player with an MC cartridge, use a commercially available MC head amp or a step-up transformer.
- If you set this unit's input source to "PHONO" and increase the volume without connecting the record player, there may be a "booming" noise from the speakers.

NOTE

The SIGNAL GND terminal of this unit is not a safety ground connection. Connect it to reduce noise when noise is excessive. Note that depending on the record player, connecting the ground line may have the reverse effect of increasing noise. In this case, it is not necessary to connect the ground line.

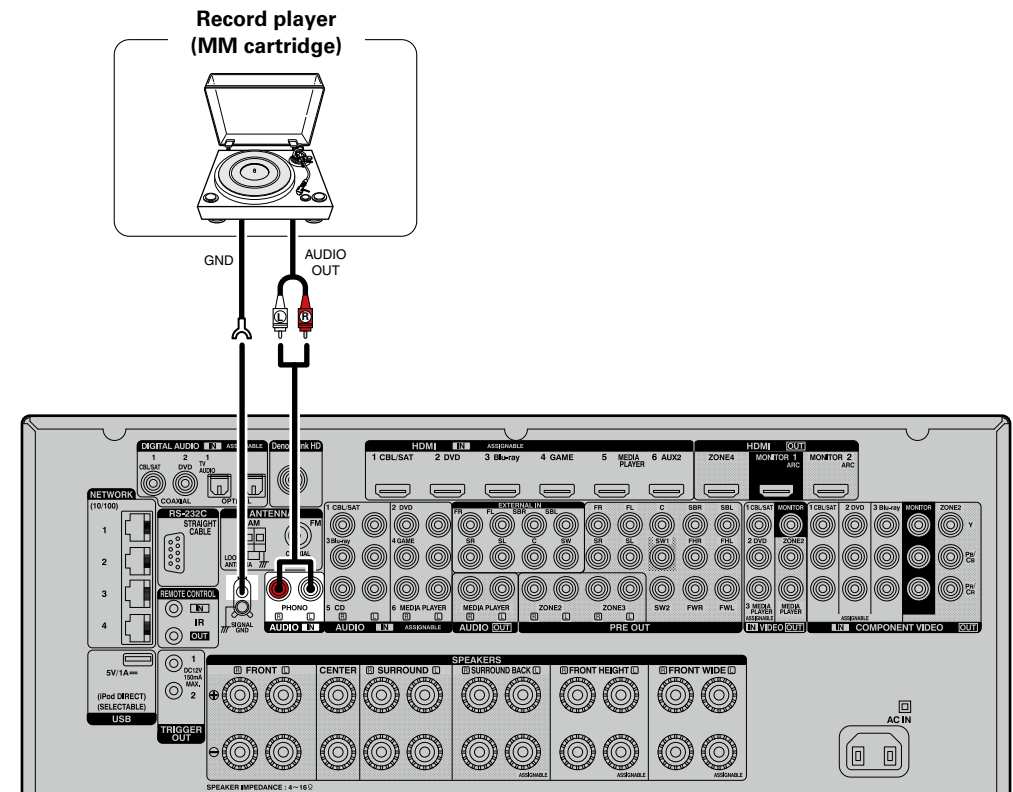

Connecting an HD Radio receiver

- By connecting a HD Radio antenna to this unit, you can receive HD Radio programs.
- HD Radio broadcasting currently is available in the United States and select other countries.
- After connecting the antenna and receiving a broadcast signal (see page 51 "Listening to HD Radio stations"), fix the antenna with tape in a position where the noise level becomes minimal.

AM loop antenna assembly

1 Put the stand section through the bottom of the loop antenna from the rear and bend it forward.

2 Insert the projecting part into the square hole in the stand.

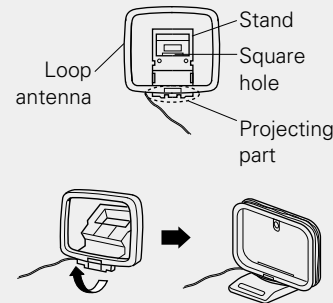

Using the AM loop antenna

Suspending on a wall

Suspend directly on a wall without assembling.

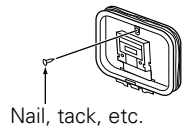

Nail, tack, etc.

Standing alone

Use the procedure shown above to assemble.

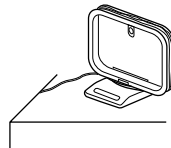

NOTE

- Do not connect two FM antennas simultaneously.
- Even if an external AM antenna is used, do not disconnect the AM loop antenna.
- Make sure the AM loop antenna lead terminals do not touch metal parts of the panel.
- If the signal has noise interference, connect the ground terminal (GND) to reduce noise.
- If you are unable to receive a good broadcast signal, we recommend installing an outdoor antenna. For details, inquire at the retail store where you purchased the unit.

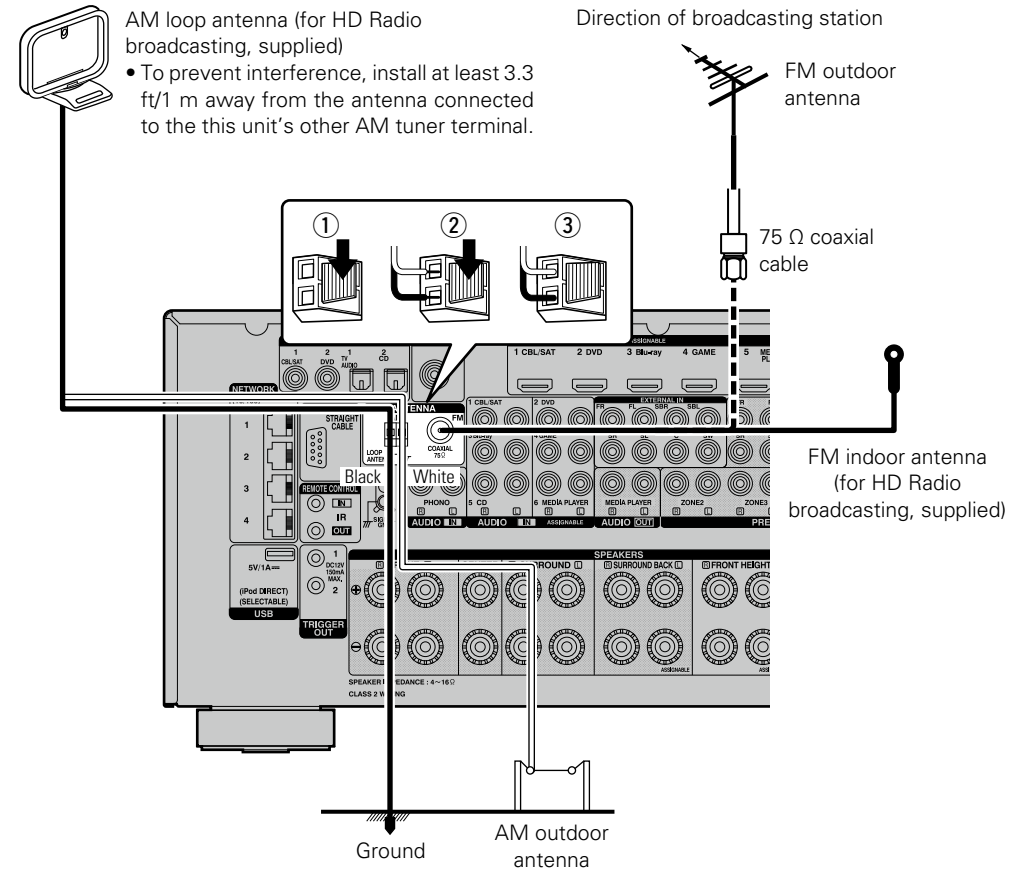

Connecting a device with a multi-channel output connector

- You can connect this unit to an external device fitted with multi-channel sound audio output connectors to enjoy music and video.
- To play analog signals input from EXTERNAL IN connectors, set "Input Mode" ([page 138](#)) to "EXTERNAL IN".
- The video signal can be connected in the same way as a Blu-ray Disc player / DVD player ([page 18](#) "Connecting a DVD player", [page 19](#) "Connecting a Blu-ray Disc player").

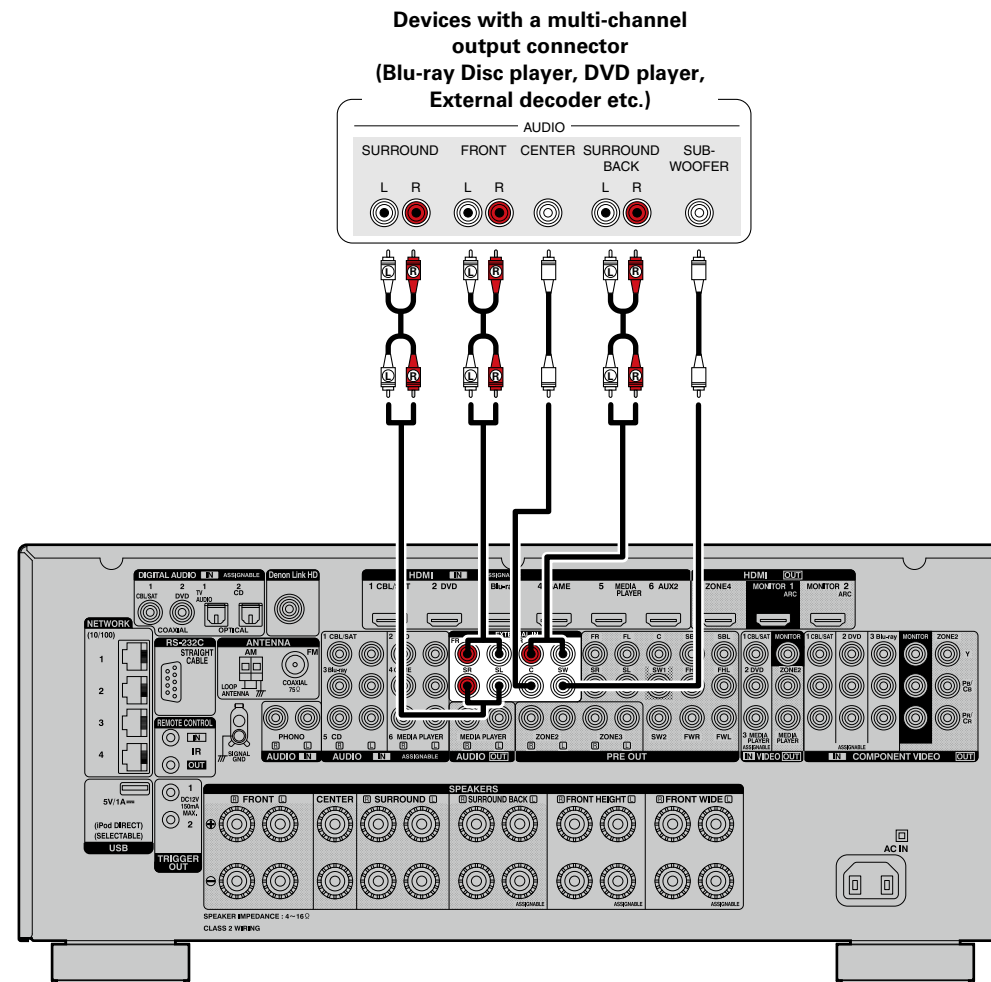

Connecting an external power amplifier

- You can use this unit as a pre-amp by connecting a commercially available power amp to the PRE OUT connector. Adding a power amp to each of the channels provides an even greater sound presence.
- Select the terminal to use and connect the device.



- When using just one surround back speaker, connect it to the left channel (L) terminal.
- Use the volume control on the subwoofer to control subwoofer volume.
- If the subwoofer volume sounds low, use the volume control provided on the subwoofer to adjust the volume.

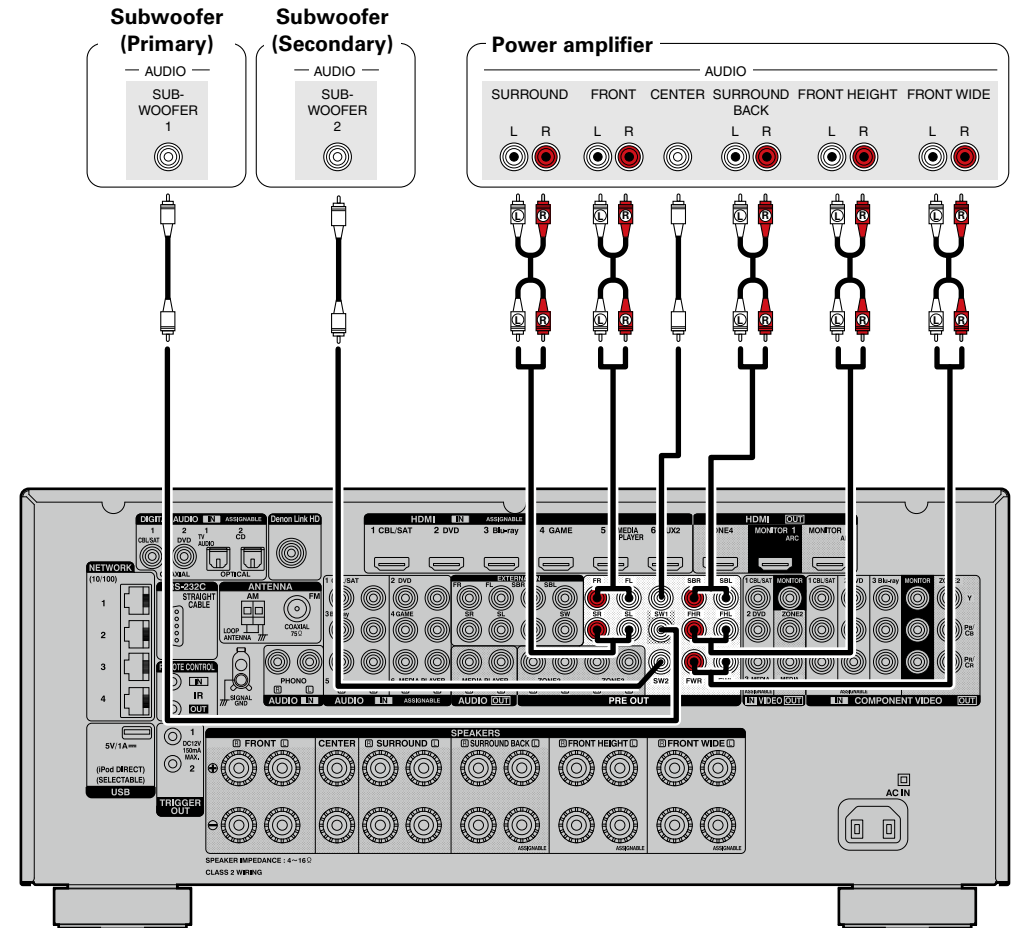

Connecting an external control device

REMOTE CONTROL jacks

If this unit is installed in a location that is out of range of the signal from the remote control unit, you can still operate the unit and the devices connected to it by using a commercially available IR receiver. You can also use it to remotely control ZONE2, ZONE3 and ZONE4 (another room).

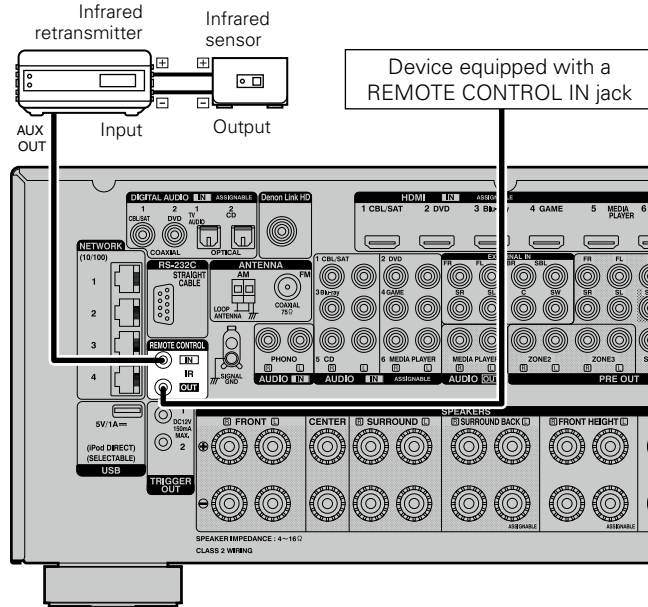

RS-232C connector

When you connect an external control device, you can control this unit with the external controller (such as power supply operation, volume adjustment, and input source switching).

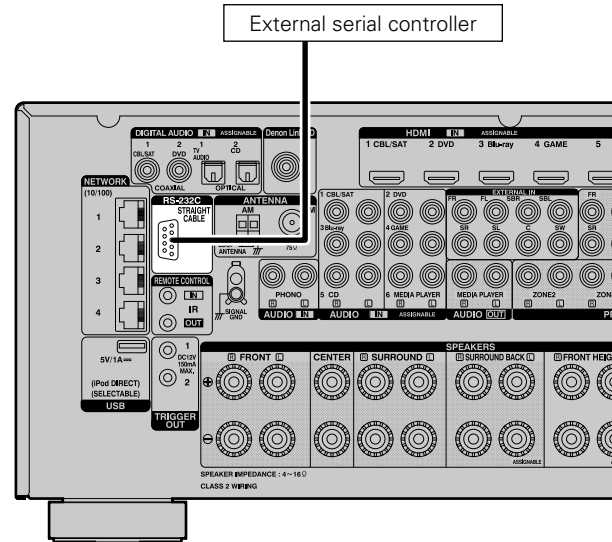

Perform the operation below beforehand.

- ① Turn on the power of this unit.
- ② Turn off the power of this unit from the external controller.
- ③ Check that the unit is in the standby mode.

TRIGGER OUT jacks

When a device with TRIGGER IN jack is connected, the connected device's power on/standby can be controlled through linked operation to this unit.

The TRIGGER OUT jack outputs a maximum 12 V/150 mA electrical signal.

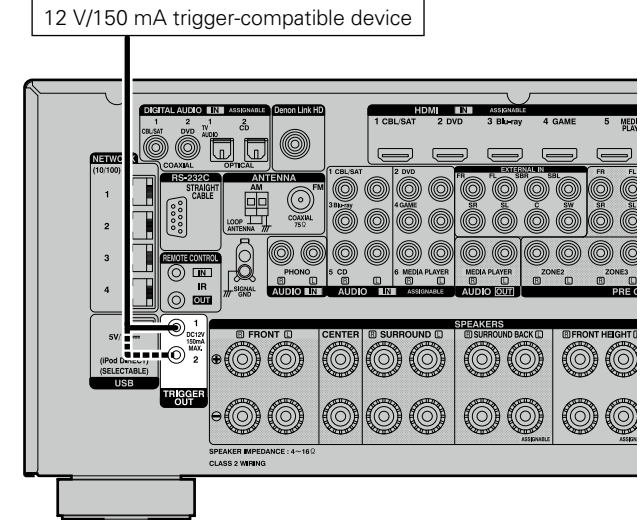

NOTE

- Use the monaural mini-plug cable for connecting TRIGGER OUT jacks. Do not use the stereo mini-plug cable.
- If the permissible trigger input level for the connected device is larger than 12 V/150 mA, or has shorted, the TRIGGER OUT jack cannot be used. In this case, turn off the power to the unit, and disconnect it.

Connecting to a home network (LAN)

You can connect this unit to your home network (LAN) to perform various types of playbacks and operations as follows. This unit is also equipped with a switching hub function. Make network connections for this unit by carefully reading information on this page.

- Playback of network audio such as the Internet Radio and Media Servers
- Playback of music from online services
- AirPlay
- Operations on this unit via the network

In addition, when an updated firmware becomes available for improving this unit, the update information is delivered from us to this unit over the network. You can then download the latest firmware. For more information, on the menu, select "Update" ([page 154](#)).

Network settings are necessary. See "Network" on the menu ([page 146](#)) for more information on network setting.

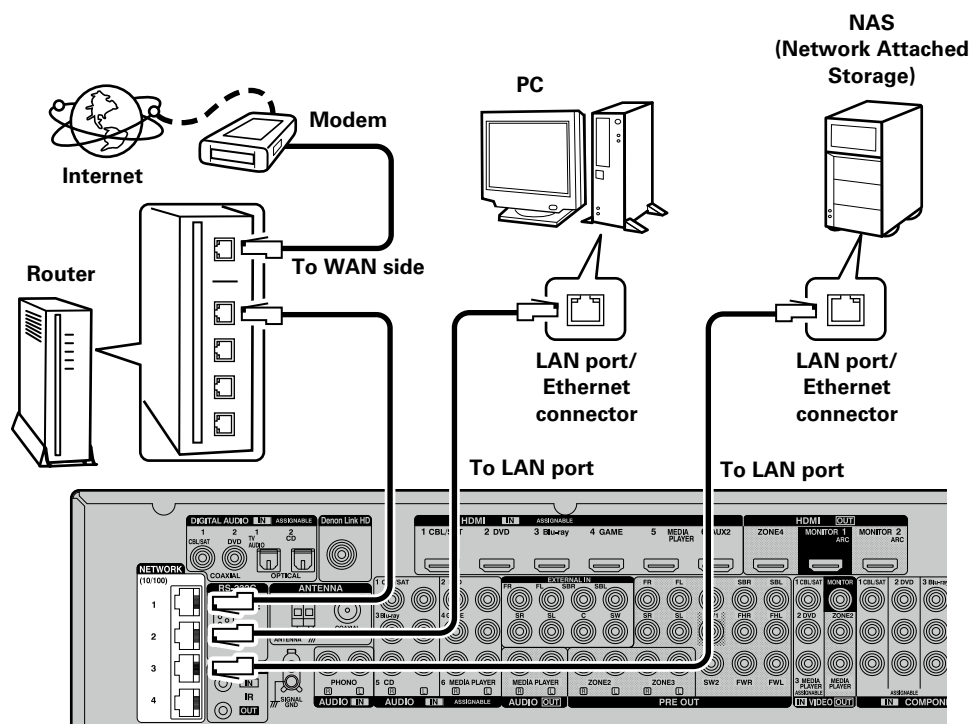

The figure above is an example. Connect the LAN cable to any of the NETWORK connectors from 1 – 4.

For connections to the Internet, contact an ISP (Internet Service Provider) or a computer shop.

Required system

❑ Broadband internet connection

❑ Modem

Device that connects to the broadband circuit and conducts communications on the Internet. A type that is integrated with a router is also available.

❑ Router

When using this unit, we recommend you use a router equipped with the following functions:

- Built-in DHCP server
This function automatically assigns IP addresses on the LAN.
- Built-in 100BASE-TX switch
When connecting multiple devices, we recommend a switching hub with a speed of 100 Mbps or greater.

NOTE

- Connect the router to one of the NETWORK connectors on this unit. Furthermore, do not use more than 2 LAN cables when connecting this unit with a router.
- When connecting a hub to this unit, connect using just 1 LAN cable per hub. Connecting with two or more LAN cables may cause a malfunction.
- To use a NETWORK connector as a hub, set "Network" ([page 147](#)) in the menu to "Always On" (default).
- The loop detection function is not provided.
- Do not connect in the following ways.

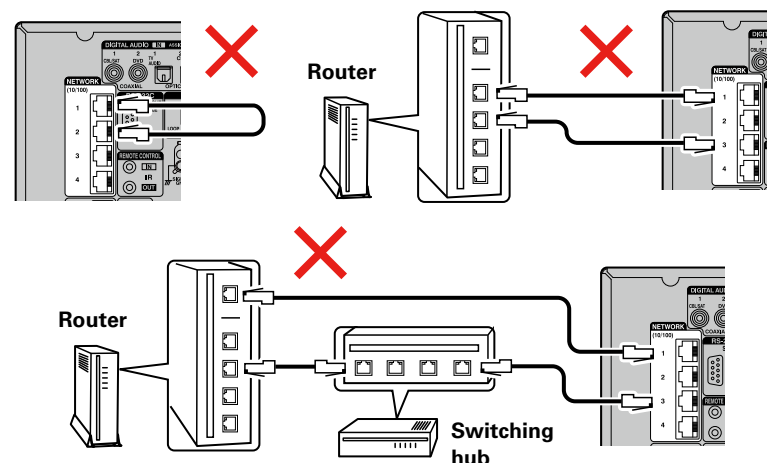

Ethernet cable

(CAT-5 or greater recommended)

- Use only a shielded STP or ScTP LAN cable which is available at retailer.
- The normal shielded-type Ethernet cable is recommended. If a flat-type cable or unshielded-type cable is used, other devices could be affected by noise.
- This product is equivalent to the crossover cable.



- If you have an Internet provider contract for a line on which network settings are made manually, make the settings at “Network” (page 146).
- With this unit, it is possible to use the DHCP and Auto IP functions to make the network settings automatically.
- When using this unit with the broadband router’s DHCP function enabled, this unit automatically performs the IP address setting and other settings.
When using this unit connected to a network with no DHCP function, make the settings for the IP address, etc., at “Network” (page 146).
- When setting manually, check the setting contents with the network administrator.

NOTE

- A contract with an ISP is required to connect to the Internet.
No additional contract is needed if you already have a broadband connection to the Internet.
- The types of routers that can be used depend on the ISP. Contact an ISP or a computer shop for details.
- DENON assumes no responsibility whatsoever for any communication errors or troubles resulting from customer’s network environment or connected devices.
- This unit is not compatible with PPPoE. A PPPoE-compatible router is required if you have a contract for a type of line set by PPPoE.
- To listen to audio streaming, use a router that supports audio streaming.

Connecting the power cord

After completing all the connections, insert the power plug into the power outlet.

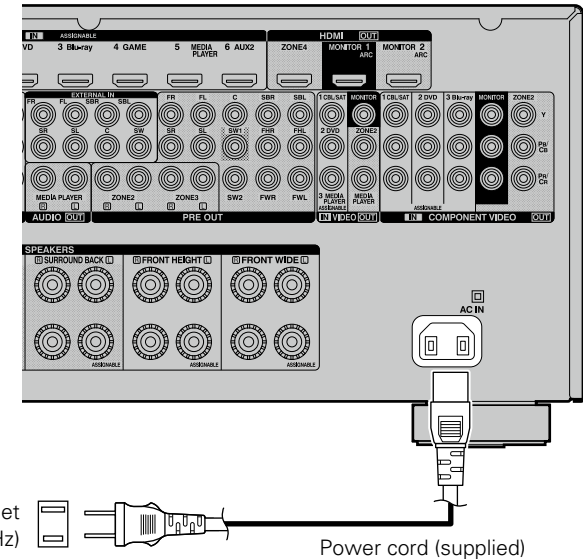

NOTE

- **Do not plug in the power cord until all connections have been completed.**
- **Do not plug in the power cord until all connections have been completed. However, when the “Setup Assistant” is running, follow the instructions in the “Setup Assistant” (page 7) screen for making connections. (During “Setup Assistant” operation, the input/output connectors do not conduct current.)**
- Do not bundle power cords together with connection cables. Doing so can result in humming or noise.

Setup

Here, we explain “Audyssey® Setup”, which allows you to automatically make the optimal settings for your speakers, and “Network”, which allows you to connect this unit to a home network (LAN).

This unit lets you play via your home network (LAN) music files stored on a computer and music content such as that from Internet Radio.

❑ **Speaker connection** (👉 [page 93](#))

❑ **Set up speakers (Audyssey® Setup)** (👉 [page 33](#))

❑ **Making the network settings (Network)**
(👉 [page 40](#))

Playback (Basic operation) (👉 [page 41](#))

Selecting a listening mode (Sound Mode)
(👉 [page 84](#))

Playback (Advanced operation) (👉 [page 102](#))



Set up speakers (Audyssey® Setup)



The acoustic characteristics of the connected speakers and listening room are measured and the optimum settings are made automatically. This is called “Audyssey® Setup”.

To perform measurement, place the setup microphone in multiple locations all around the listening area. For best results, we recommend you measure in six or more positions, as shown in the illustration (up to eight positions).

- When performing Audyssey® Setup, Audyssey MultEQ® XT 32/Audyssey Dynamic EQ®/Audyssey Dynamic Volume® functions become active (👉 [page 125, 126](#)).
- To set up the speakers manually, use “Speakers” (👉 [page 139](#)) on the menu.

NOTE

- Make the room as quiet as possible. Background noise can disrupt the room measurements. Close windows and turn off the power on electronic devices (TVs, radios, air conditioners, fluorescent lights, etc.). The measurements could be affected by the sounds emitted by such devices.
- During the measurement process, place cell phones outside the listening room. Cell phone signals could disrupt the measurements.
- Do not unplug the setup microphone from the main unit until Audyssey® Setup is completed.
- Do not stand between the speakers and setup microphone or allow obstacles in the path while the measurements are being made. This will cause inaccurate readings.
- During the measurement process, loud test sounds may be played, but this is part of normal operation. If there is background noise in room, these test signals will increase in volume.
- Operating **VOLUME ▲▼** on the remote control unit or **MASTER VOLUME** on the main unit during the measurements will cancel the measurements.



- Measurement cannot be performed when headphones are connected. Unplug the headphones before performing Audyssey® Setup.

About setup microphone placement

- Measurements are performed by placing the setup microphone successively at multiple positions throughout the entire listening area, as shown in **[Example ①]**. For best results, we recommend you measure in six or more positions, as shown in the illustration (up to eight positions).
- Even if the listening environment is small as shown in **[Example ②]**, measuring at multiple points throughout the listening environment results in more effective correction.

[Example ①]

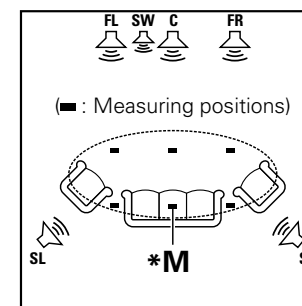

[Example ②]

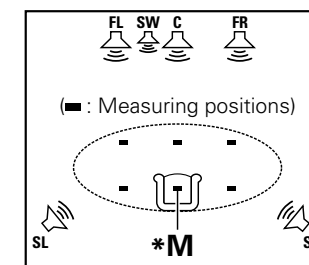

FL Front speaker (L)
FR Front speaker (R)
C Center speaker

SW Subwoofer
SL Surround speaker (L)
SR Surround speaker (R)

About the main listening position (*M)

The main listening position is the position where listeners would normally sit or where one would normally sit alone within the listening environment. Before starting Audyssey® Setup, place the setup microphone in the main listening position. Audyssey MultEQ® XT 32 uses the measurements from this position to calculate speaker distance, level, polarity, and the optimum crossover value for the subwoofer.

1 Prepare the included setup microphone

Mount the setup microphone on a tripod or stand and place it in the main listening position.

When placing the setup microphone, adjust the height of the sound receptor to the level of the listener's ear.

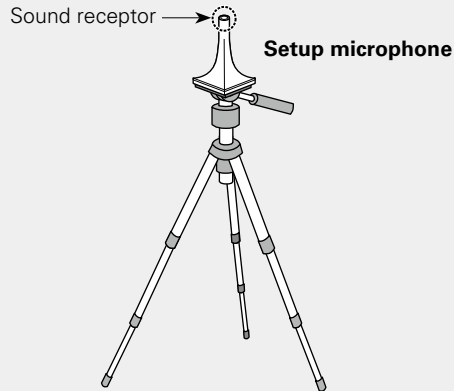

If you do not have a tripod or stand, set up the microphone on, for example, a seat without a back.

NOTE

- Do not hold the setup microphone in your hand during measurements.
- Avoid placing the setup microphone close to a seat back or wall as sound reflections may give inaccurate results.

About Audyssey Sub EQ HT™

Audyssey Sub EQ HT™ makes the integration seamless by first compensating for any level and delay differences between the two subwoofers and then applying Audyssey MultEQ® XT 32 to both subwoofers together.

* To run Audyssey Sub EQ HT™ you must select "Measure (2 spkrs)" in "Set up "Channel Select"" (page 101).

2 Set up the subwoofer

If using a subwoofer capable of the following adjustments, set up the subwoofer as shown below.

For details, see your subwoofer's manual.

□ When using a subwoofer with a direct mode

Set the direct mode to "On" and disable the volume adjustment and crossover frequency setting.

□ When using a subwoofer without a direct mode

Make the following settings:

- **Volume** : "12 o'clock position"
- **Crossover frequency** : "Maximum/Highest Frequency"
- **Low pass filter** : "Off"
- **Standby mode** : "Off"

NOTE

When using 2 subwoofers at the same time, before starting Audyssey® Setup, adjust the volume of the subwoofers by using "Subwoofer Level" (page 121) from the menu. You cannot set the volume for individual subwoofers.

3 Set up the zone mode

Press **ZONE SELECT** to switch the zone mode.

The **M** indicator lights.

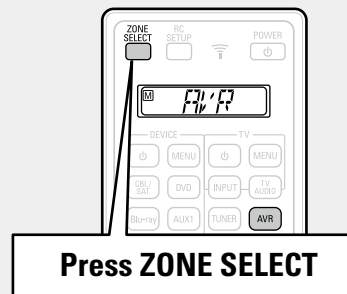

NOTE

When using a remote control with preset codes registered (page 160), press **AVR** to set the remote control to the AVR-operation mode before operation.

Preparation

4 Connect the setup microphone to the SETUP MIC jack of this unit.

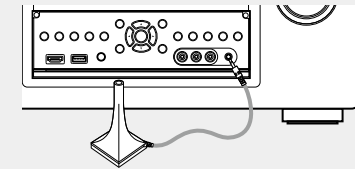

When the setup microphone is connected, the following screen is displayed.

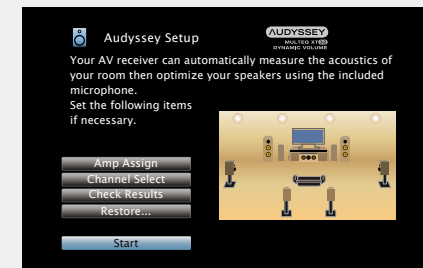

- Here, we explain setup using the example of 7.1-channel speaker playback.

For settings other than 7.1-channel speaker playback, select "Amp Assign" and perform step 3 to 10 of "Set up "Amp Assign"" (page 99).

If unused channels are set with "Channel Select", measuring time can be shortened. For setting, perform steps 13 to 19 of "Set up "Channel Select"" (page 101).

Preparation (Continued)

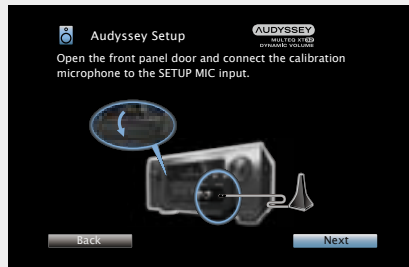
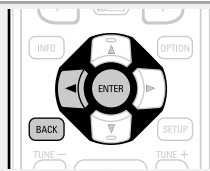
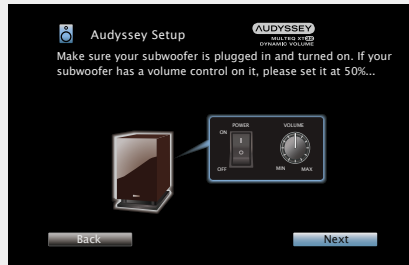
5 Select “Start” and then press **ENTER**.**6** Select “Next” and then press **ENTER**.
The subwoofer volume setting screen is displayed.

Detection & Measurement (Main)

This step automatically checks the speaker configuration and speaker size, and calculates the channel level, distance, and crossover frequency. It also corrects distortion in the listening area.

7 Select “Begin Test” and then press **ENTER**.
The volume level for the subwoofer is measured.

- If the volume level for the subwoofer is not appropriate, an error message is displayed. See “Subwoofer level error message and how to adjust” (page 39) and adjust the volume level for the subwoofer.
- Measurement requires several minutes.
- To stop measuring, select “Cancel” and then press **ENTER**.

8 The detected speakers are displayed.

- The illustration below shows an example of when the front speakers, center speaker, subwoofer, surround and surround back speakers have been detected.

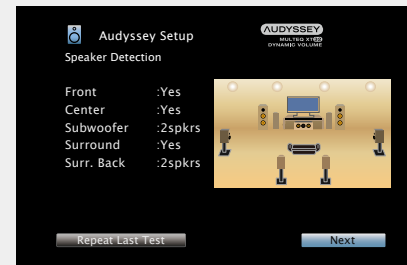
**NOTE**

If a connected speaker is not displayed, the speaker may not be connected correctly. Check the speaker connection.

9 Select “Next” and then press **ENTER**.**NOTE**

If “Caution!” is displayed on TV screen:

Go to “Error messages” (page 38). Check any related items, and perform the necessary procedures.

If the problem is resolved, return and restart “Audyssey® Setup”.

Going back to the previous screen

Select “Back” and then press **ENTER**.

When measuring has stopped

- ① Press **BACK** to display the popup screen.
- ② Press < to select “Yes”, and then press **ENTER**.

Setting up the speakers again

Repeat the operation from step 4.

Measurement (2nd – 8th)

- In this step, you will perform measurements at multiple positions (two to eight positions) other than the main listening position.
- Just one position can be measured but measuring multiple positions increases the accuracy of the correction of acoustic distortion within the listening area.

10 Move the setup microphone to position 2, select “Continue”, and then press ENTER.

The measurement of the second position starts. Measurements can be made in up to eight positions.

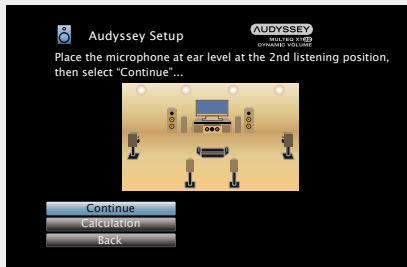

- To skip measuring the third and subsequent listening position, use $\Delta \nabla$ to select “Calculation” and press **ENTER** to proceed to step 13.
- To measure the second position again, use $\Delta \nabla$ to select “Repeat Last Test” and press **ENTER**.

Calculation

11 Repeat step 10, measuring positions 3 to 8.

When measurement of position 8 is completed, a “Measurements finished.” message is displayed.

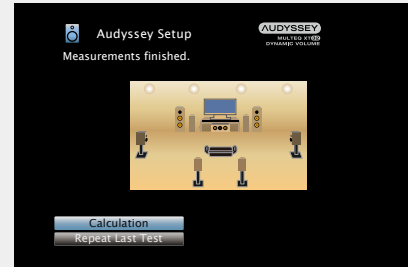

12 Select “Calculation” and then press ENTER.

Measuring results are analyzed, and the frequency response of each speaker in the listening room is determined.

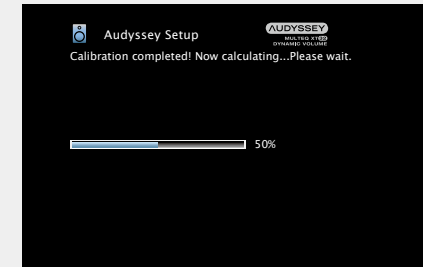

- Analysis takes several minutes to complete. The more speakers and measurement positions that there are, the more time it takes to perform the analysis.

Check

- 13** Use Δ / ∇ to select the item you want to check, and then press **ENTER**.

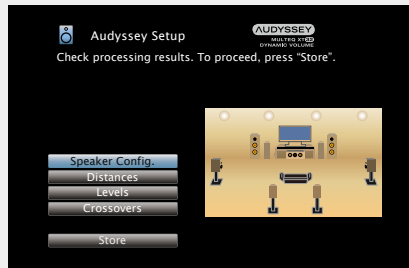

- Subwoofers may measure a greater reported distance than the actual distance due to added electrical delay common in subwoofers.
- If you want to check another item, press **BACK**.

NOTE

- If the result differs from the actual connection status, or if “Caution!” is displayed, see “Error messages” ([page 38](#)). Then carry out Audyssey® Setup again.
- If you change speaker positions or orientation, perform Audyssey® Setup again to find the optimal equalizer settings.

Store

- 14** Select “Store” and then press **ENTER**.
Save the measurement results.

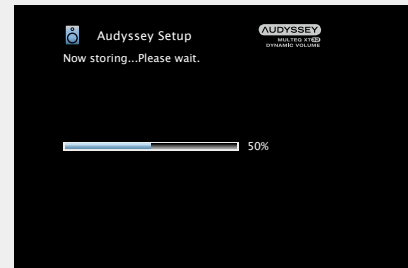
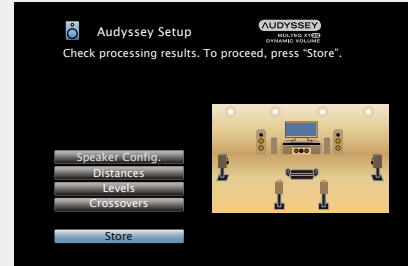

- Saving the results requires about 20 seconds.
- During saving of measurements results, “Now storing...Please wait.” is displayed. When saving is completed, “Storing complete. Audyssey® Setup is now finished. Please unplug microphone.” is displayed.

NOTE

During saving of measurement results, be sure not to turn off the power.

Finish

- 15** Unplug the setup microphone from the unit’s **SETUP MIC** jack.

- 16** Set Audyssey Dynamic Volume®.

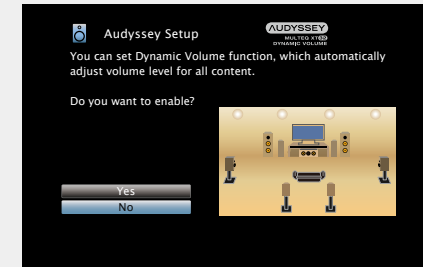

- This feature adjusts the output volume to the optimal level while constantly monitoring the level of the audio input to the unit. Optimal volume control is performed automatically without any loss in the dynamism and clarity of the sound when, for example, the volume suddenly increases for commercials shown during television programs.

When turning Dynamic Volume on

- Press Δ to select “Yes”, and then press **ENTER**.
The unit automatically enters “Medium” ([page 126](#)) mode.

When turning Dynamic Volume off

- Press ∇ to select “No”, and then press **ENTER**.

NOTE

After performing Audyssey® Setup, do not change the speaker connections or subwoofer volume. In event of a change, perform Audyssey® Setup again.

Error messages

NOTE

- An error message is displayed if Audyssey® Setup could not be completed due to speaker placement, the measurement environment, etc. If an error message is displayed, check the relevant items and perform the necessary measures. Then perform Audyssey® Setup again.
- If the result still differs from the actual connection status after remeasurement or the error message still appears, it is possible that the speakers are not connected properly. Turn this unit off, check the speaker connections and repeat the measurement process from the beginning.
- Be sure to turn off the power before checking speaker connections.

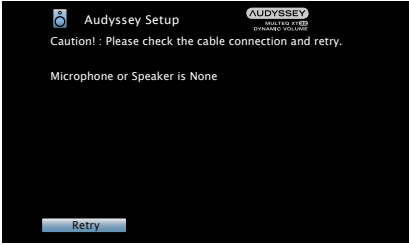
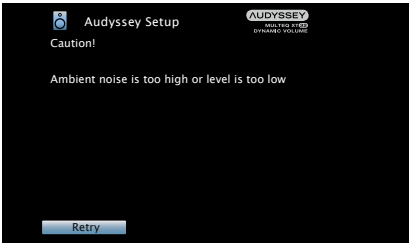
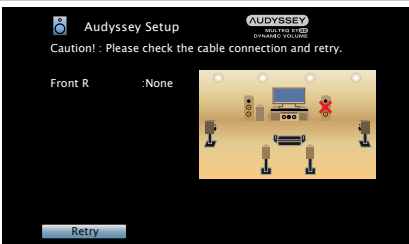
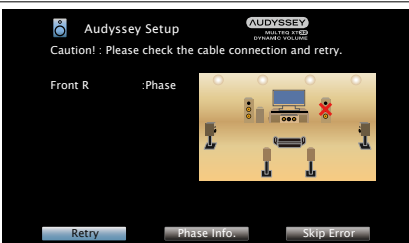
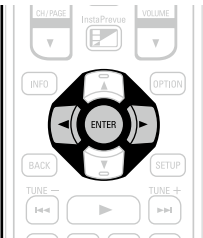
Examples	Error details	Measures
 <p>Audyssey Setup CAUTION! : Please check the cable connection and retry. Microphone or Speaker is None Retry</p>	<ul style="list-style-type: none"> • The connected setup microphone is broken, or a device other than the supplied setup microphone is connected. • Not all speakers could be detected. 	<ul style="list-style-type: none"> • Connect the included setup microphone to the SETUP MIC jack of this unit. • Check the speaker connections.
 <p>Audyssey Setup CAUTION! Ambient noise is too high or level is too low Retry</p>	<ul style="list-style-type: none"> • There is too much noise in the room for accurate measurements to be made. • Speaker or subwoofer sound is too low for accurate measurements to be made. 	<ul style="list-style-type: none"> • Either turn off any device generating noise or move it away. • Perform again when the surroundings are quieter. • Check the speaker installation and the direction in which the speakers are facing. • Adjust the subwoofer's volume.
 <p>Audyssey Setup CAUTION! : Please check the cable connection and retry. Front R :None Retry</p>	<ul style="list-style-type: none"> • The displayed speaker could not be detected. (The screen on the left indicates that the front right speaker cannot be detected.) 	<ul style="list-style-type: none"> • Check the connections of the displayed speaker.
 <p>Audyssey Setup CAUTION! : Please check the cable connection and retry. Front R :Phase Retry Phase Info. Skip Error</p>	<ul style="list-style-type: none"> • The displayed speaker is connected with the polarity reversed. (The screen on the left indicates that the polarity phases of the front right speakers are reversed.) 	<ul style="list-style-type: none"> • Check the polarity of the displayed speaker. • For some speakers, this error message may be displayed even if the speaker is properly connected. If you are sure the connection is correct, use ◀▶ to select "Skip Error", then press ENTER. 

❑ Subwoofer level error message and how to adjust

The optimal level of each subwoofer channel for Audyssey Setup measurement is 75 dB.

During subwoofer level measurement (see [page 33](#) “Set up speakers (Audyssey® Setup)”), an error message is displayed when one level of subwoofers is outside the 72 – 78 dB range.

When using a subwoofer with built-in amplifier (active type), adjust the subwoofer volume so that the subwoofer level is within the 72 to 78 dB range.

[Error message]

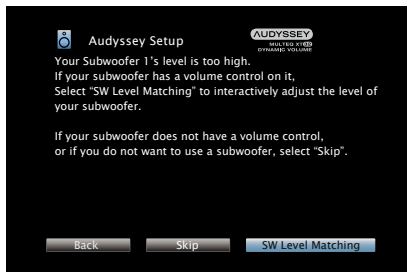

1 Select “SW Level Matching” and then press ENTER.

Subwoofer level measurement begins. During measuring, a “Calibrating...” message is displayed. The measured level appears on the level indicator after about 3 to 5 seconds.

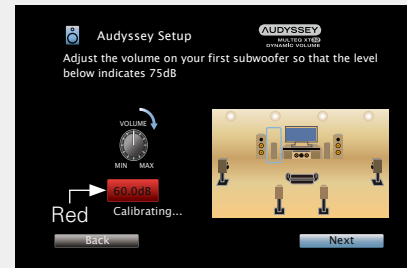
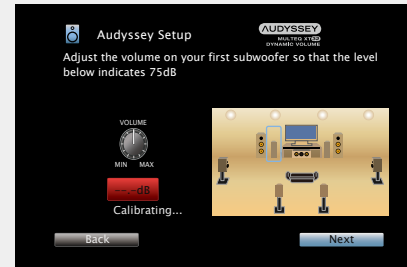
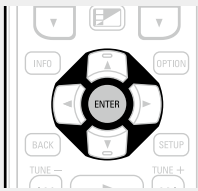

- If the measured level is outside the 72 to 78 dB range, the level indicator is red.
- When measuring finishes, select “Back” and then press **ENTER**.

2 Adjust the volume control on your subwoofer so that the measured level is within the 72 to 78 dB range.

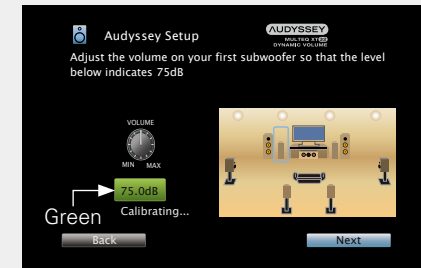

- If the measured level is within the 72 to 78 dB range, the level indicator is green.

3 When the measured level is within the 72 to 78 dB range, select “Next” and then press ENTER.

- If you use two subwoofers, the second subwoofer’s adjust will be started. Repeat the operation from step 2, 3.



When you use two subwoofers, adjust each subwoofer so that the volume levels of Subwoofer 1 and Subwoofer 2 are appropriate for your needs.

Check Results

This function enables you to check the measurement results and equalizer characteristics after Audyssey® Setup.

- 1** Press **SETUP** to display the menu on the TV screen.
- 2** Use Δ / ∇ to select “Speakers” – “Audyssey® Setup” and then press **ENTER** or \triangleright .
- 3** Use Δ / ∇ to select “Check Results” and then press **ENTER**.

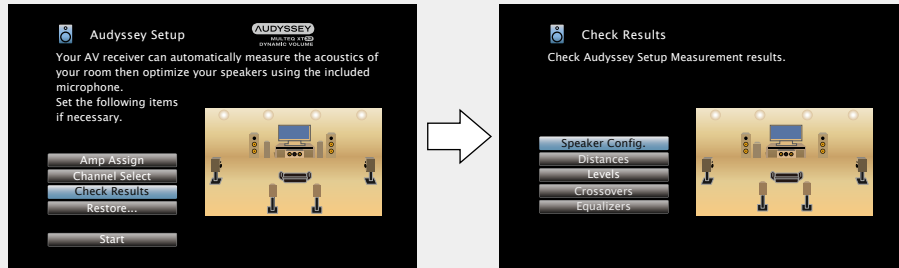

- 4** Use Δ / ∇ to select the item you want to check, then press **ENTER**.
Measurement results for each speaker are displayed.

Speaker Config.	Check the speaker configuration.
Distances	Check the speaker distance.
Levels	Check the speaker channel level.
Crossovers	Check the speaker crossover frequency.
Equalizers	Check the equalizer.

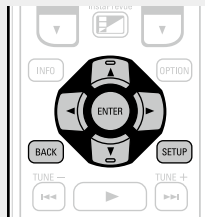

- If “Equalizers” is selected, press Δ / ∇ to select equalizing curve (“Audyssey” or “Audyssey Flat”) to be checked.
Use Δ / ∇ to switch the display between the different speakers.

- 5** Press \triangleleft or **BACK**.
The confirmation screen reappears. Repeat step 2.

Retrieving Audyssey® Setup settings

If you set “Restore...” to “Restore”, you can return to Audyssey® Setup measurement result (value calculated at the start by MultEQ® XT 32) even when you have changed each setting manually.



Making the network settings (Network)



This unit can be connected to a home network (LAN) to listen to Internet Radio or play back music files and still image (JPEG) files stored on a computer.

- 1** Connect the Ethernet cable (☞ [page 31](#) “Connecting to a home network (LAN)”).
- 2** Turn on this unit (☞ [page 41](#)).
This unit performs automatic network setup due to the DHCP function.
When connecting to a network that has no DHCP function, perform the setting in “Settings” (☞ [page 148](#)).

Playback (Basic operation)

Setup (page 33)

- ❑ Turning the power on (page 41)
- ❑ Selecting the input source (page 41)
- ❑ Adjusting the master volume (page 42)
- ❑ Turning off the sound temporarily (page 42)

- ❑ Playing a Blu-ray Disc player/DVD player (page 42)
- ❑ Playing a Blu-ray Disc player compatible with Denon Link HD (page 42)
- ❑ Playing Super Audio CD (page 43)
- ❑ Playing a CD player (page 43)
- ❑ Playing an iPod (page 44)
- ❑ Playing a USB memory device (page 47)
- ❑ Listening to HD Radio stations (page 50)

- ❑ Listening to Internet Radio (page 59)
- ❑ Playing back files stored on a PC and NAS (page 62)
- ❑ Using online services (page 66)
- ❑ Convenient functions (page 76)
- ❑ AirPlay function (page 82)

Selecting a listening mode (Sound Mode) (page 84)

Playback (Advanced operation) (page 102)

Important information

Before starting playback, make the connections between the different devices and the settings on the unit.

NOTE

Also refer to the operating instructions of the connected devices when playing them.

Turning the power on

Press **POWER** to turn on power to the unit.

The power indicator flashes green and the power turns on.

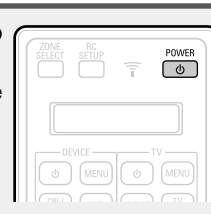

You can also switch the power to standby by pressing **POWER** on the main unit.

When power is switched to standby

Press **POWER**.

[Power indicator status in standby mode]

- Normal standby : Off
- When "HDMI Pass Through" or "HDMI Control" (page 130) is set to "On" : Red
- When "Network" (page 147) is set to "Always On" : Red
- When a mobile device that supports MHL is being charged : Red

Selecting the input source

Press the input source select button (**CBL/SAT, Blu-ray, GAME, MEDIA PLAYER, DVD, AUX1, AUX2, CD, TUNER, PHONO, NETWORK, TV AUDIO, iPod/USB** or **INTERNET RADIO**) to be played back.

The desired input source can be selected directly.

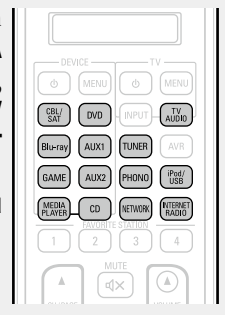

You can also use the following operation to select an input source.

Select the input source using the main unit

Turn **SOURCE SELECT**.

- Turning **SOURCE SELECT** switches the input source, as shown below.

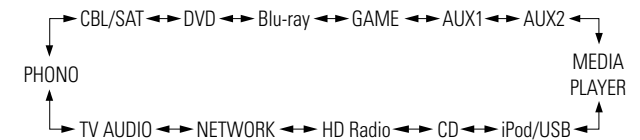

Adjusting the master volume

Use **VOLUME ▲▼** to adjust the volume.

- The volume display method varies depending on the "Scale" setting ([page 124](#)).

□ When the "Scale" setting ([page 124](#)) is "0 – 98"

[Adjustable range] 0.0 0.5 – 98.0

□ When the "Scale" setting ([page 124](#)) is "–79.5dB – 18.0dB"

[Adjustable range] ----- –79.5dB – 18.0dB

- The variable range differs according to the input signal and channel level setting.



You can also adjust the master volume by turning **MASTER VOLUME** on the main unit.

Turning off the sound temporarily

Press **MUTE** .

- "MUTE" indicator on the display flashes.
-  appears on a TV screen.



- The sound is reduced to the level set at "Mute Level" ([page 124](#)).
- To cancel, press **MUTE**  again. Muting can also be canceled by adjusting the master volume.

Playing a Blu-ray Disc player/DVD player

The following describes the procedure for playing Blu-ray Disc player/DVD player.

1 Prepare for playback.

- Turn on the power of the TV, subwoofer and player.
- Change the TV input to the input of this unit.
- Load the disc in the player.

2 Press **POWER** to turn on power to the unit.

3 Press **Blu-ray** or **DVD** to switch an input source for a player used for playback.

4 Play the Blu-ray Disc player or DVD player.

- Make the necessary settings on the player (language setting, subtitles setting, etc.) beforehand.

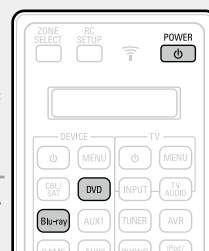

Playing a Blu-ray Disc player compatible with Denon Link HD

- Denon Link HD uses the clock of the AV amplifier connected by Denon Link to achieve HDMI signal transfer with low jitter when playing BD.
- To play Denon Link HD signals, make HDMI and Denon Link connections with a compatible Blu-ray disc player ([page 13](#) "Connecting a player compatible with the Denon Link HD function").

1 Prepare for playback.

- Turn on the power of the TV, subwoofer and player.
- Change the TV input to the input of this unit.
- Load the disc in the player.

2 Press **POWER** to turn on power to the unit.

3 Perform the settings of the "Input Assign" menu ([page 135](#)).

- Assign HDMI connectors for the input source (example: Blu-ray).
- Set "DIGITAL" to "D.LINK".
 - The default assign of "D.LINK" is "Blu-ray".

4 Press the input source select button (example: **Blu-ray**) to switch an input source assigned in step 3 - ①.

5 Set the audio input mode to "Auto" or "HDMI" using the "Input Mode" menu ([page 138](#)).

- The default setting of "Input Mode" is "Auto".

6 Play the component connected to this unit.

- Make the necessary settings on the player (language setting, subtitles setting, etc.) beforehand.

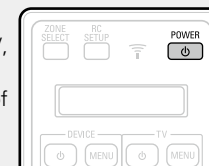

Playing a Blu-ray Disc player compatible with Denon Link HD

NOTE

- Set the Blu-ray disc player's "Denon Link" setting to "On". For instructions on operation, refer to the Blu-ray disc player's manual.
- When a Blu-ray disc is played with the "Input Mode" (☞ [page 138](#)) set to "Auto" or "HDMI", playback is performed in the Denon Link HD mode.

Playing Super Audio CD

The following describes the procedure for playing Super Audio CD.

1 Prepare for playback.

- ① Turn on the power of the subwoofer and player.
- ② Load the disc in the player.

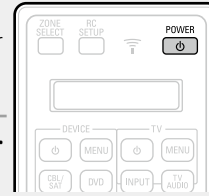

2 Press POWER to turn on power to the unit.

3 Perform the settings of the "Input Assign" menu (☞ [page 135](#)).

Assign HDMI connectors for the input source (example: DVD).

4 Press the input source select button (example: DVD) to switch an input source assigned in step 3.

5 Set the audio input mode to "Auto" using the "Input Mode" menu (☞ [page 138](#)).

- The default setting of "Input Mode" is "Auto".

6 Play the component connected to this unit.

The [DSD] indicator lights on the display.



When playing back Super Audio CD, DSD signals are converted into PCM signals which are then converted into analog signals.

Playing a CD player

The following describes the procedure for playing CD player.

1 Prepare for playback.

- ① Turn on the power of the subwoofer and player.
- ② Load the disc in the player.

2 Press POWER to turn on power to the unit.

3 Press CD to switch the input source to "CD".

4 Play the CD player.



Playing an iPod

You can use the USB cable provided with the iPod to connect the iPod with the unit's iPod/USB port and enjoy music stored on the iPod.

For information on the iPod models that can be played back with this unit, see "Connecting an iPod or USB memory device to the iPod/USB port" ([page 23](#)).

Listening to music on an iPod

The iPod display modes include "From iPod" and "On-Screen".

By default, "From iPod", where you directly operate iPod itself while seeing the iPod screen, is set.

To change to "On-Screen", where you perform operations while having the iPod information displayed on the TV screen, see "Setting operation mode (iPod Browse Mode)" ([page 45](#)).

1 Using the USB cable provided with the iPod, connect the iPod to the iPod/USB port ([page 23](#)).

2 Press **POWER**  to turn on power to the unit.

3 Press **iPod/USB** to switch the input source to "iPod/USB".

"Remote iPod" is displayed on the display of this unit.

• Nothing is displayed on the TV screen.

4 Operate iPod itself directly while seeing the iPod screen to play back music.

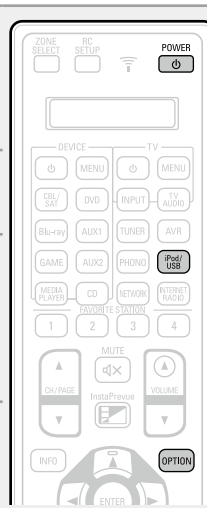

- Streaming music stored in iPhone, iPod touch, or iPad directly to the unit ([page 82](#))
- Playing iTunes music with this unit ([page 82](#))

Operations available through the OPTION button

Press the **OPTION** button to display a menu of functions that can be used on the TV screen. Select the function you want to use from this menu. You can easily find and use the desired function.

Setting the USB port to use (USB Select)
([page 76](#))

Setting operation mode (iPod Browse Mode)
([page 45](#))

Performing repeat playback (Repeat)
([page 46](#))

Performing random playback (Random)
([page 46](#))

Adjusting the picture quality for your viewing environment (Picture Mode) ([page 80](#))

All Zone Stereo function ([page 80](#))

❑ Setting operation mode (iPod Browse Mode)

In this mode, various lists and screens during playback on iPod are displayed on the TV screen.

This section describes the steps up to playing back tracks on iPod in "On-Screen".

1 Press **iPod/USB** to switch the input source to "iPod/USB".

2 Press **OPTION**.
The option menu screen is displayed.

3 Select "iPod Browse Mode", then press **ENTER**.
The "iPod Browse Mode" screen is displayed.

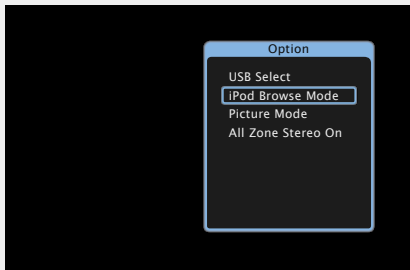

4 Use **◀ ▶** to select "On-Screen", then press **ENTER**.
The iPod screen is displayed.

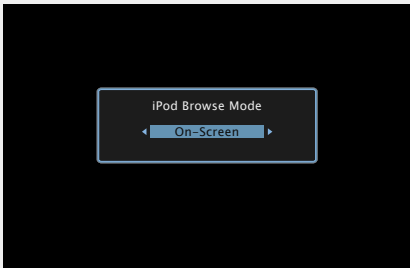

- English letters, numbers and certain symbols are displayed. Incompatible characters are displayed as "." (period).
- Operations available for "On-Screen" and "From iPod" are listed below.

Display mode		From iPod	On-Screen
Playable files	Music file	✓	✓
	Video file	*	
Active buttons	Remote control unit (This unit)	✓	✓
	iPod	✓	

* Only the sound is played.

5 Use **△▽** to select the item, then press **ENTER** or **▶** to select the file to be played.

6 Press **ENTER**, **▶** or **▶▶**.
Playback starts.

❑ Adjusting the sound quality (Restorer)

Make this setting at "Restorer" ([page 124](#)) in the menu.

You can use the "Restorer" function to restore to a state close to the audio before compression while correcting the bass feel to enjoy a richer playback experience. The default setting is "Mode 3 (Low)".

❑ Changing the screen display duration

Make this setting at "Now Playing" ([page 133](#)) in the menu. The default setting is "Always On".

When "Auto Off" is set, the on-screen display is turned off 30 seconds after an operation.

Press **△▽◀▶** while the display is off to return to the original screen.

❑ Switching the screen display

Press **STATUS** on this unit during playback with "iPod Browse Mode" set to "On-Screen".

The display switches between track title, artist name, and album title etc. each time the button is pressed.

NOTE

- Depending on the type of iPod and the software version, some functions may not operate.
- Note that DENON will accept no responsibility whatsoever for any problems arising with the data on an iPod when using this unit in conjunction with the iPod.

❑ Performing repeat playback (Repeat)

1 Press **OPTION** with “iPod Browse Mode” set to “On-Screen”.
The option menu screen is displayed.

2 Use Δ / ∇ to select “Repeat”, then press **ENTER**.

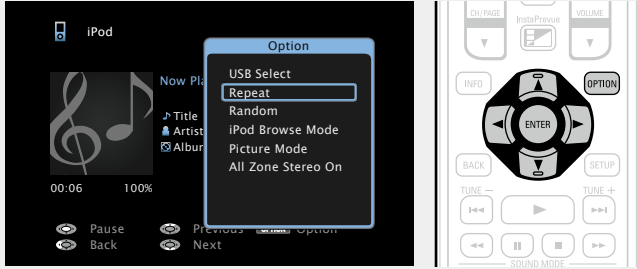

3 Use \triangleleft / \triangleright to select repeat playback mode.

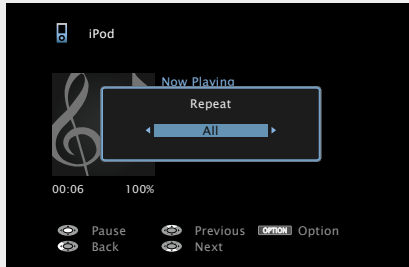

• Each time \triangleleft / \triangleright is pressed, the setting is changed as shown below.



Off Repeat playback mode is canceled.

One A file being played is played repeatedly.

All All files in the folder currently being played are played repeatedly.

4 Press **ENTER**.
The display returns to the playback screen.

❑ Performing random playback (Random)

1 Press **OPTION** with “iPod Browse Mode” set to “On-Screen”.
The option menu screen is displayed.

2 Use Δ / ∇ to select “Random”, then press **ENTER**.

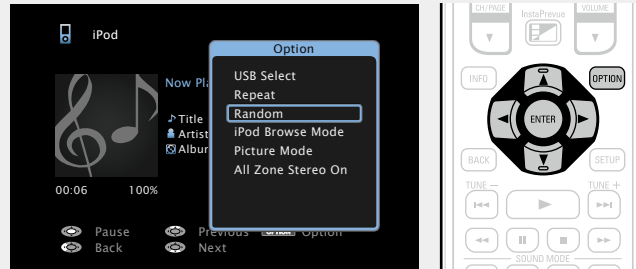

3 Use \triangleleft / \triangleright to select random playback mode.

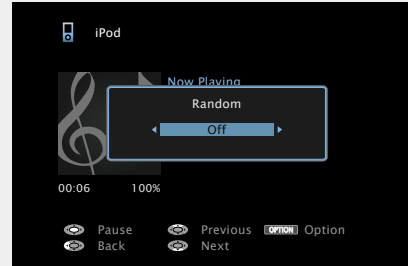

• Each time \triangleleft / \triangleright is pressed, the setting is changed as shown below.



Off Disable random playback.

On Enable random playback.

4 Press **ENTER**.
The display returns to the playback screen.



The random playback randomly selects a track to play back from all tracks every time a track ends. Therefore, the same track may be played back consecutively.

❑ iPod operation buttons



Operation buttons	Function
CH/PAGE \blacktriangle / \blacktriangledown	Page search
INFO	Display of information such as the source name, volume, and sound mode name
OPTION	USB Select / Repeat playback / Random playback / iPod Browse Mode switching / Picture Mode / All Zone Stereo
\triangleleft / \triangleright / \triangleleft / \triangleright	Cursor operation / Auto search (cue, Δ / ∇) / Manual search (Press and hold, Δ / ∇)
ENTER (Press and release)	Enter
ENTER (Press and hold)	Stop
BACK	Return
SETUP	Setup menu
\blacktriangleleft \blacktriangleright	Auto search (cue)
\blacktriangleright	Playback / Pause
\blacktriangleleft \blacktriangleright (Press and hold)	Manual search (fast-reverse/fast-forward)
\parallel	Pause
\blacksquare	Stop

Playing a USB memory device

Playing back music or still picture (JPEG) files recorded on a USB memory device.

Important information

- Only USB memory devices conforming to mass storage class and MTP (Media Transfer Protocol) standards can be played on this unit.
- This unit is compatible with USB memory devices in “FAT16” or “FAT32” format.
- This unit is compatible with MP3 files conforming to “MPEG-1 Audio Layer-3” standards.
- File types that this unit can play back and specifications are shown below.

[Supported file types]

Supported file types	USB memory devices *1
WMA (Windows Media Audio)	✓*2
MP3 (MPEG-1 Audio Layer-3)	✓
WAV	✓
MPEG-4 AAC	✓*3
FLAC (Free Lossless Audio Codec)	✓
JPEG	✓
ALAC (Apple Lossless Audio Codec)	✓

*1 USB memory device

- This unit is compatible with MP3 ID3-Tag (Ver. 2) standard.
- This unit can show the artwork that was embedded by using MP3 ID3-Tag Ver. 2.3 or 2.4.
- This unit is compatible with WMA META tags.
- If the image size (pixels) of an album artwork exceeds 500 × 500 (WMA/MP3/WAV/FLAC) or 349 × 349 (MPEG-4 AAC), then music may not be played back properly.
- WAV format Quantization bit length: 16 or 24 bits.
- FLAC format Quantization bit length: 16 or 24 bits.

*2 Copyright-protected files can be played on certain portable players compatible with MTP.

*3 Only files that are not protected by copyright can be played on this unit.

Content downloaded from pay sites on the Internet are copyright protected. Also, files encoded in WMA format when ripped from a CD, etc. on a computer may be copyright protected, depending on the computer’s settings.

NOTE

File types that this unit does not support are not displayed.

[Compatible formats]

	Sampling frequency	Bit rate	Extension
WMA (Windows Media Audio)	32/44.1/48 kHz	48 – 192 kbps	.wma
MP3 (MPEG-1 Audio Layer-3)	32/44.1/48 kHz	32 – 320 kbps	.mp3
WAV	32/44.1/48/88.2/96/ 176.4/192 kHz	–	.wav
MPEG-4 AAC	32/44.1/48 kHz	16 – 320 kbps	.aac/ .m4a/ .mp4
FLAC (Free Lossless Audio Codec)	32/44.1/48/88.2/96/ 176.4/192 kHz	–	.flac
ALAC (Apple Lossless Audio Codec)*	32/44.1/48/88.2/96 kHz	–	.m4a

* Copyright [2012] [D&M Holdings. Inc.]

Licensed under the Apache License, Version 2.0 (the “License”); you may not use this file except in compliance with the License. You may obtain a copy of the License at <http://www.apache.org/licenses/LICENSE-2.0>

Maximum Number of Playable Files and Folder

The limits on the number of folders and files that can be displayed by this unit are as follows.

Item	Media	USB memory devices
Memory capacity		FAT16 : 2 GB, FAT32 : 2 TB
Number of folder directory levels *1		8 levels
Number of folders		500
Number of files *2		5000

*1 The limited number includes the root folder.

*2 The allowable number of files may differ according to the USB memory device capacity and the file size.

Playing files stored on USB memory devices

1 Connect the USB memory device to the iPod/USB port (☞ [page 23](#)).

2 Press iPod/USB to switch the input source to “iPod/USB”.

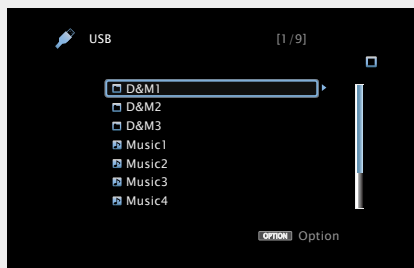

3 Use Δ / ∇ to select the search item or folder, then press ENTER or \triangleright .

4 Use Δ / ∇ to select the file, then press ENTER, \triangleright or \blacktriangleright . Playback starts.

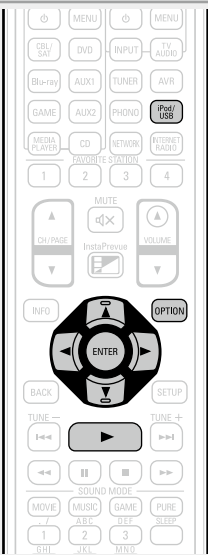

Adjusting the sound quality (Restorer)

Make this setting at “Restorer” (☞ [page 124](#)) in the menu.

You can use the “Restorer” function to restore to a state close to the audio before compression while correcting the bass feel to enjoy a richer playback experience. The default setting is “Mode 3 (Low)”.

Going back to the previous screen

Press \triangleleft or BACK.

Changing the screen display duration

Make this setting at “Now Playing” (☞ [page 133](#)) in the menu. The default setting is “Always On”.

When “Auto Off” is set, the on-screen display is turned off 30 seconds after an operation.

Press Δ / ∇ / \triangleleft \triangleright while the display is off to return to the original screen.



- When an MP3 music file includes album art data, the album art can be displayed while playing the file.
- If the USB memory device is divided into multiple partitions, only the first partition is played back.

NOTE

- Note that DENON will accept no responsibility whatsoever for any problems arising with the data on a USB memory device when using this unit in conjunction with the USB memory device.
- USB memory devices will not work via a USB hub.
- DENON does not guarantee that all USB memory devices will operate or be supplied power. When using a USB portable hard disk that can draw power from an AC adapter, we recommend using the AC adapter.
- It is not possible to connect and use a computer via the iPod/USB port of this unit using a USB cable.

Operations available through the OPTION button

Press the **OPTION** button to display a menu of functions that can be used on the TV screen. Select the function you want to use from this menu. You can easily find and use the desired function.

Setting the USB port to use (USB Select)

(☞ [page 76](#))

Searching content with keywords (Text Search)

(☞ [page 76](#))

Performing repeat playback (Repeat)

(☞ [page 77](#))

Performing random playback (Random)

(☞ [page 77](#))

Playing back music and a favorite picture at the same time (Slideshow)

(☞ [page 79](#))

Playing back still images in sequential order (Slideshow Interval)

(☞ [page 79](#))

All Zone Stereo function

(☞ [page 80](#))

□ USB memory device operation buttons

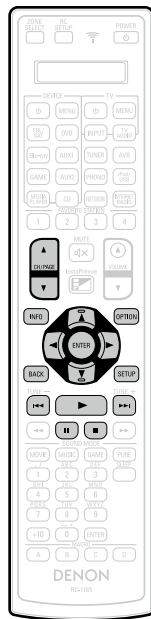

Operation buttons	Function
CH/PAGE ▲▼	Page search
INFO	Display of information such as the source name, volume, and sound mode name
OPTION	USB Select / Text Search / Repeat playback / Random playback / Slideshow / Slideshow Interval / All Zone Stereo
△▽◀▶	Cursor operation / Auto search (cue, △▽)
ENTER (Press and release)	Enter
ENTER (Press and hold)	Stop
BACK	Return
SETUP	Setup menu
I◀◀▶▶I	Auto search (cue)
▶	Playback / Pause
 	Pause
■	Stop

Listening to HD Radio stations

For antenna connections, see “Connecting an HD Radio receiver” (🔗 [page 27](#)).

Important information

❑ Using the HD Radio™ receiver

HD Radio stations offer higher sound quality than conventional FM/ AM broadcasts. It is also possible to receive data services and select broadcasts from among up to eight multicast programs.

HD Radio Technology provides higher quality sound than conventional broadcasts and allows reception of data services.

Digital Sound

- Digital, CD-quality sound. HD Radio Technology enables local radio stations to broadcast a clean digital signal. AM sounds like today’s FM and FM sounds like a CD.

PSD

- Program Service Data: Contributes to the superior user experience of HD Radio Technology. Presents song name, artist, station IDs, and other relevant data streams.

HD2/HD3

- Adjacent to traditional main stations are extra local FM channels. These HD2/HD3 Channels provide new, original music as well as deep cuts into traditional genre.



HD Radio Technology manufactured under license from iBiquity Digital Corporation. U.S. and Foreign Patents. HD Radio™ and the HD, HD Radio, and “Arc” logos are proprietary trademarks of iBiquity Digital Corp.

For detailed information on HD Radio Technology, please go to “www.hdradio.com/”.

How to tune in

The modes for receiving FM broadcasts consists of “Auto” mode that automatically searches available broadcast stations and “Manual” mode that lets you tune in using buttons to change the frequency. The default setting is “Auto”. You can also use “Direct Tune” to tune in by entering the frequency directly. In “Auto” mode, you cannot tune in to radio stations if the reception is not good. If this is the case, then use the “Manual” mode or “Direct Tune” to tune in.

Listening to HD Radio stations

- 1** Press **TUNER** to switch the input source to “HD Radio”.

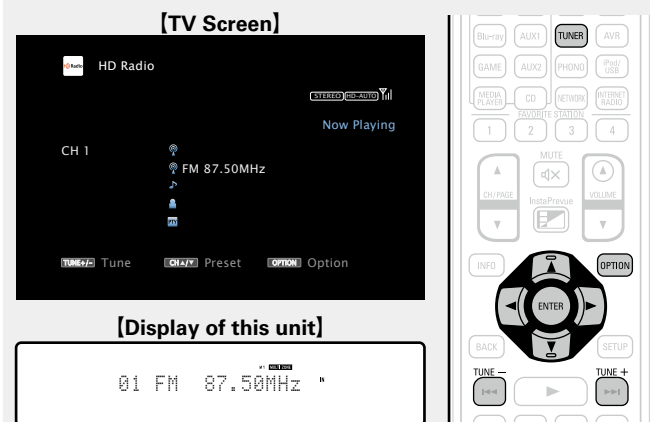

- 2** Press **OPTION**.
The option menu screen is displayed.

- 3** Use Δ / ∇ to select “FM/AM”, then press **ENTER**.
The Band screen is displayed.

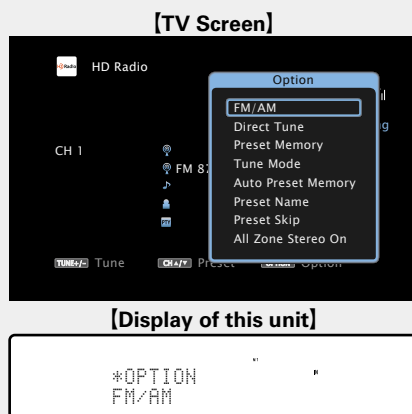

- 4** Use \triangleleft / \triangleright to select “FM” or “AM”, then press **ENTER**.

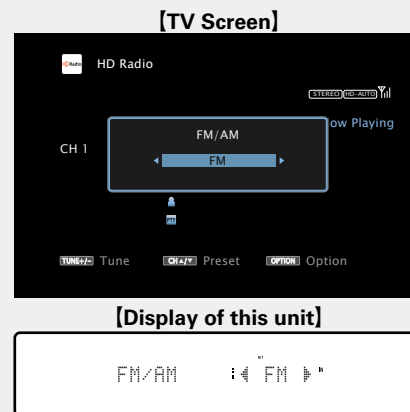

FM When listening to an FM broadcast.

AM When listening to an AM broadcast.

- 5** Press **TUNE +** or **TUNE -** to select the station you want to hear.
Scanning is performed until it finds an available radio station. When it finds a radio station, it stops the scan automatically and tunes in.



- If the desired station cannot be tuned in with auto tuning, tune it in manually.
- When tuning in stations manually, press and hold **TUNE +** or **TUNE -** to change frequencies continuously.

Changing the screen display duration

Make this setting at “Now Playing” ([page 133](#)) in the menu. The default setting is “Always On”.

When “Auto Off” is set, the on-screen display is turned off 30 seconds after an operation.

Press Δ / ∇ / \triangleleft / \triangleright while the display is off to return to the original screen.

Adding to the FAVORITE STATION button

([page 78](#))

Operations available through the OPTION button

Press the **OPTION** button to display a menu of functions that can be used on the TV screen. Select the function you want to use from this menu. You can easily find and use the desired function.

Changing the tuning mode (Tune Mode)

([page 52](#))

Tuning in by entering the radio frequency (Direct Tune)

([page 53](#))

Tuning in to radio stations and presetting them automatically (Auto Preset Memory)

([page 54](#))

Presetting the current broadcast station (Preset Memory)

([page 55](#))

Specify a name for the preset broadcast station (Preset Name)

([page 56](#))

Skipping preset broadcast stations (Preset Skip)

([page 57](#))

All Zone Stereo function

([page 80](#))

❑ Changing the tuning mode (Tune Mode)

You can change the mode for tuning into FM/AM broadcasts.

1 Press **TUNER** to switch the input source to “HD Radio”.

2 Press **OPTION**.
The option menu screen is displayed.

3 Use $\Delta \nabla$ to select “Tune Mode”, then press **ENTER**.

[TV Screen]

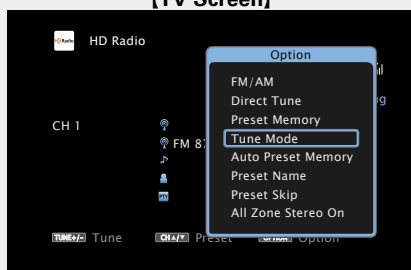

[Display of this unit]

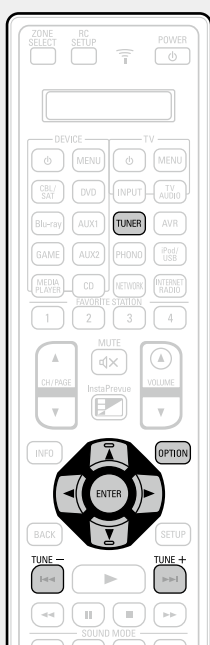
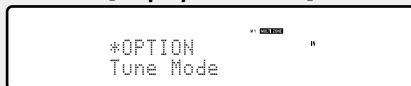

4 Use $\triangleleft \triangleright$ to select tuning mode, then press **ENTER**.

[TV Screen]

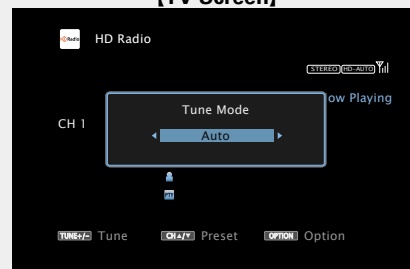

[Display of this unit]

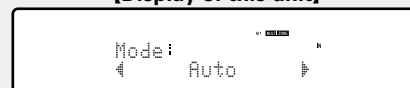

- Auto** Automatically tune to the station.
- HD-Auto** Automatically tune to the HD Radio station.
- Analog-Auto** Automatically tune to an analog station and analog HD Radio station.
- Manual** Manually tune to the station.
- Analog-Manual** Manually tune to an analog station and analog HD Radio station.



When tuning in stations manually, press and hold **TUNE +** or **TUNE -** to change frequencies continuously.

❑ Selecting audio programs

HD Radio Technology enables stations to broadcast multiple Audio Program and data services on HD2 / HD3 / HD4 channels.

1 Select the tuning mode (“HD-Auto”, “Auto” or “Manual”).

2 Press **TUNE +** or **TUNE -** to tune in the desired Multicast channel.

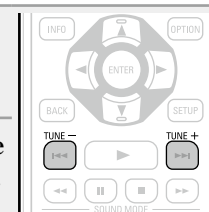

- If the station you are tuning in has multiple audio programs, “HD1” is indicated on the display.
- If it only has one audio program, “HD” is indicated.
- When the unit receives multicast channels, the multicast program number (HD2) is displayed to the right of the station name.

NOTE

- This function is not available for AM HD Radio stations because they cannot broadcast multicast channels.
- If digital audio data cannot be received after the station is selected, or if the station signal is weak, the unit may not be able to receive the multicast channels.
- If the station signal is weak, the digital audio of the multicast channel may cut out.

❑ Changing the screen display duration

Make this setting at “Now Playing” ([page 133](#)) in the menu. The default setting is “Always On”.

When “Auto Off” is set, the on-screen display is turned off 30 seconds after an operation.

Press $\Delta \nabla \triangleleft \triangleright$ while the display is off to return to the original screen.

□ **Tuning in by entering the radio frequency (Direct Tune)**

You can enter the receiving frequency directly to tune in.

1 Press **TUNER** to switch the input source to “HD Radio”.

2 Press **OPTION**.
The option menu screen is displayed.

3 Use Δ / ∇ to select “Direct Tune”, then press **ENTER**.
The direct tuner screen is displayed and “-” in the display flashes.

[TV Screen]



[Display of this unit]

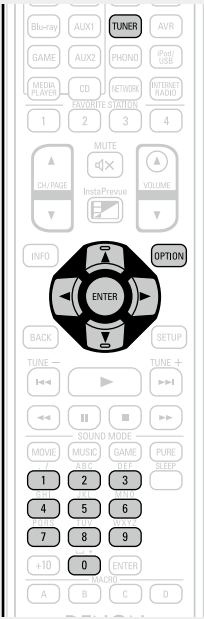
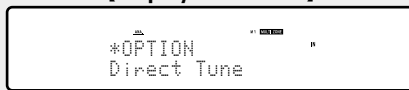

4 Use Δ / ∇ or **0 – 9** to select a number and press \triangleright .
The screen that lets you enter the frequency is displayed.

[TV Screen]

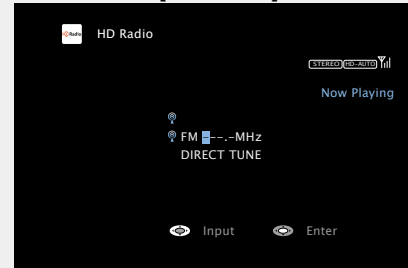

[Display of this unit]



• If \triangleleft is pressed, the immediately preceding input is cancelled.

5 Repeat step 4 and enter the frequency of the radio station you want to hear.

6 When setting is completed, press **ENTER**.
The preset frequency is tuned in.

Presetting broadcast stations

□ Tuning in to radio stations and presetting them automatically (Auto Preset Memory)

Up to 56 stations can be preset.

If "Auto Preset Memory" is performed after performing "Preset Memory", the "Preset Memory" settings will be overwritten.

1 Press **TUNER** to switch the input source to "HD Radio".

2 Press **OPTION**.
The option menu screen is displayed.

3 Use Δ / ∇ to select "Auto Preset Memory", then press **ENTER**.

[TV Screen]

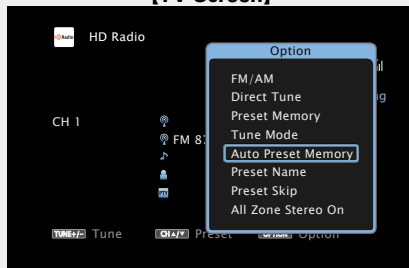

[Display of this unit]

```
*OPTION
Auto Preset
```



4 Press **ENTER**.
The unit starts to tune in to radio stations automatically and preset them.

[TV Screen]



[Display of this unit]

```
Auto Preset
Start
```

- When presetting is completed, "Completed" is displayed for about 5 seconds and the option menu screen turns off.

❑ Presetting the current broadcast station (Preset Memory)

Your favorite broadcast stations can be preset so that you can tune them in easily. Up to 56 stations can be preset.

1 Tune in the broadcast station you want to preset.

2 Press **OPTION**.
The option menu screen is displayed.

3 Use $\Delta \nabla$ to select “Preset Memory”, then press **ENTER**.
The list of already preset channels is displayed.

[TV Screen]

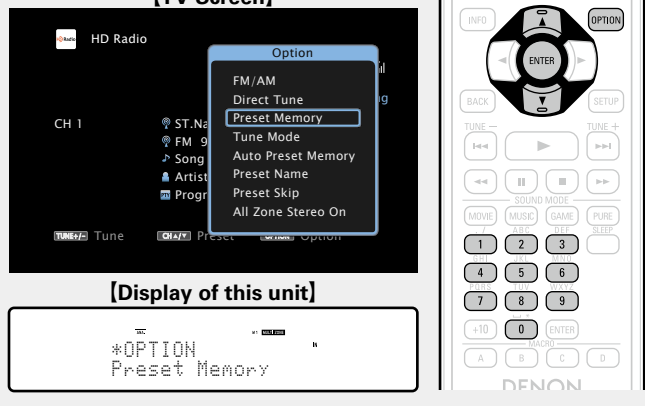

[TV Screen]

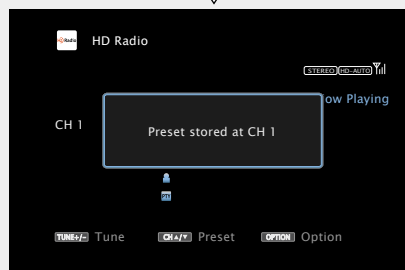
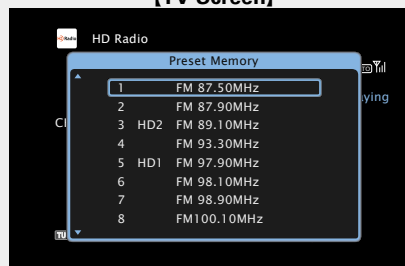

[Display of this unit]

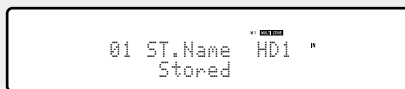
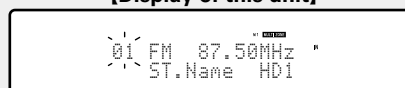

The channel numbers of broadcast stations set as “Preset Skip” (see page 57) are grayed out, but these stations can be preset. When grayed out channel numbers are preset, these are highlighted and the “Preset Skip” setting changes to “On”.

4 Use $\Delta \nabla$ or **0 – 9** to select the channel you want to preset, then press **ENTER**.

The current broadcast station that is preset.

- To preset other stations, repeat steps 1 to 4.

Channel	Default Settings
1 – 8	87.50 / 87.90 / 89.10 / 93.30 / 97.90 / 98.10 / 98.90 / 100.10 MHz
9 – 16	101.90 / 102.70 / 107.90 / 90.10 / 90.10 / 90.10 / 90.10 / 90.10 MHz
17 – 24	530 / 600 / 930 / 1000 / 1120 / 1210 / 1400 / 1710 kHz
25 – 32	90.10 / 90.10 / 90.10 / 90.10 / 90.10 / 90.10 / 90.10 / 90.10 MHz
33 – 40	90.10 / 90.10 / 90.10 / 90.10 / 90.10 / 90.10 / 90.10 / 90.10 MHz
41 – 48	90.10 / 90.10 / 90.10 / 90.10 / 90.10 / 90.10 / 90.10 / 90.10 MHz
49 – 56	90.10 / 90.10 / 90.10 / 90.10 / 90.10 / 90.10 / 90.10 / 90.10 MHz

Listening to preset stations

Use **CH/PAGE** $\Delta \nabla$ or **0 – 9** to select the desired preset channel.

[Display of this unit]

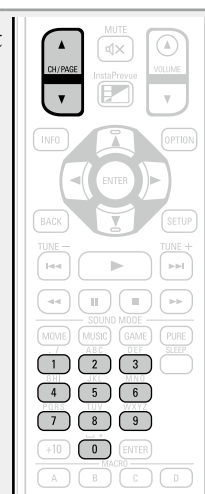
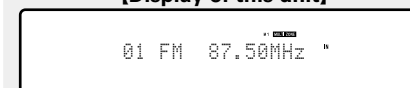

Specify a name for the preset broadcast station (Preset Name)

You can set the name to the preset broadcast station or change it. Up to eight characters can be input.

1 Press **TUNER** to switch the input source to "HD Radio".

2 Press **OPTION**.
The option menu screen is displayed.

3 Use $\Delta \nabla$ to select "Preset Name", then press **ENTER**.
The Preset Name screen is displayed.

[TV Screen]

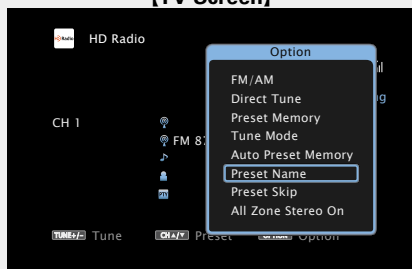

[Display of this unit]

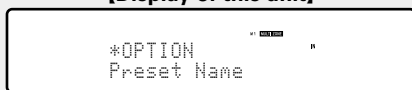

4 Use $\triangleleft \triangleright$ to select the group of the broadcast station you want to name then press **ENTER**.

The screen that lets you edit the preset name is displayed.

- Each time $\triangleleft \triangleright$ is pressed, the setting is changed as shown below.

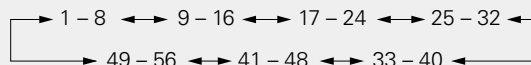

[TV Screen]

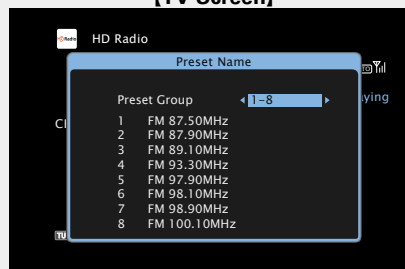

[Display of this unit]

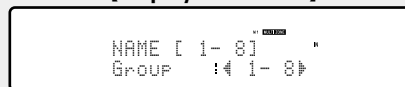

5 Use $\Delta \nabla$ to select the broadcast station you want to name, then press **ENTER**.

[TV Screen]

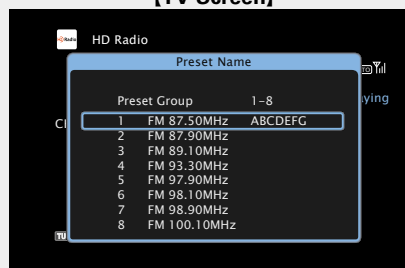

[Display of this unit]

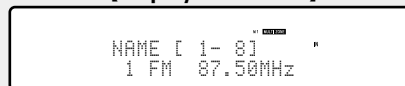

6 Use $\Delta \nabla$ to select a name label, then press **ENTER**.

The screen that lets you edit the preset name is displayed.

- If you select "Set Defaults", then the unit returns to displaying the frequency.

7 Enter the characters, then press **OK**.

- For character input, see [page 118](#).

8 Press **BACK** twice.

The display returns to the playback screen.

❑ Skipping preset broadcast stations (Preset Skip)

You can set in advance, the stations you do not want to be displayed when tuning in, by groups or by stations. The preset skip setting is useful when tuning in, because only your favorite stations are displayed.

1 Press **TUNER** to switch the input source to "HD Radio".

2 Press **OPTION**.
The option menu screen is displayed.

3 Use $\Delta \nabla$ to select "Preset Skip", then press **ENTER**.
The Preset Skip screen is displayed.

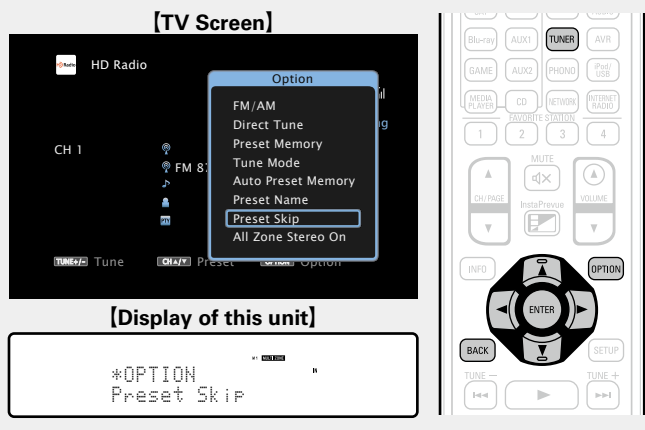

4-1 [To set the stations you want to skip by groups]

① Use $\triangleleft \triangleright$ to select the group of broadcast stations you want to skip.

- Each time $\triangleleft \triangleright$ is pressed, the setting is changed as shown below.

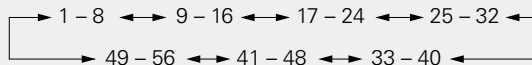

② Press Δ to select "Set * - * to Skip", then press **ENTER**.

All broadcast stations in the group "* - *" you selected are not displayed.
(* are the selected group numbers)

③ Press **BACK**.

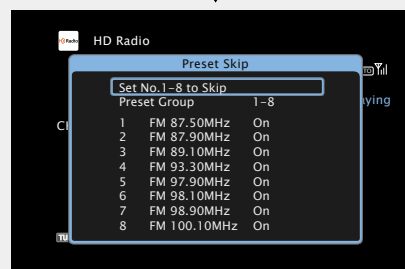
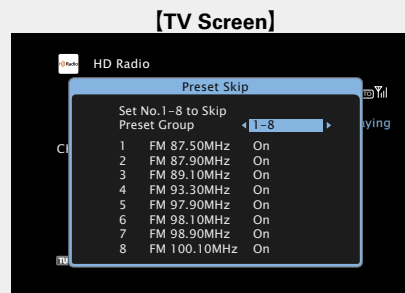

[Display of this unit]

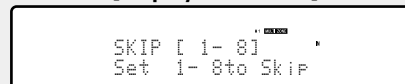

4-2 [To set the stations you want to skip by stations]

① Use $\triangleleft \triangleright$ to select the group of broadcast stations you want to skip.

- Each time $\triangleleft \triangleright$ is pressed, the setting is changed as shown below.

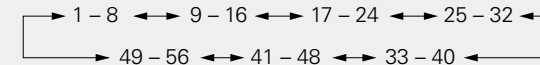

② Use $\Delta \nabla$ to select the broadcast station you want to skip.

③ Use $\triangleleft \triangleright$ to select "Skip".
The station you selected is not displayed.

④ Press **BACK**.

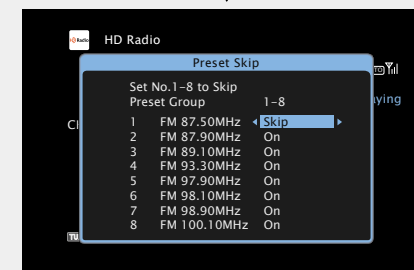
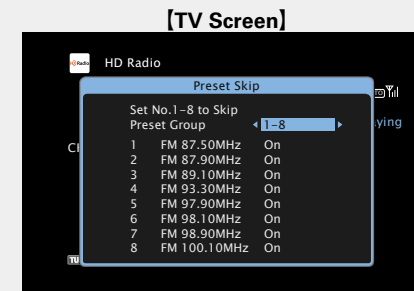

[Display of this unit]

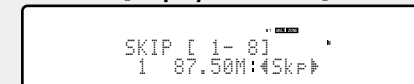

Cancelling preset skip

1 While the Preset Skip screen is displayed, use ◀ ▶ to select a group containing a broadcast station to cancel the skip for.

2 Use ▲ ▼ to select a broadcast station to cancel the skip for.

[TV Screen]



[Display of this unit]

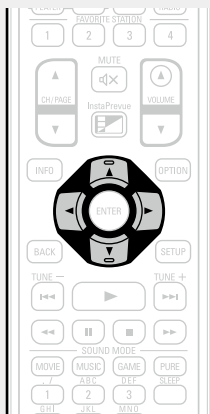
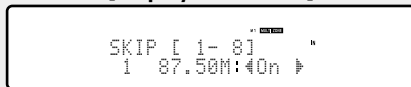

3 Use ◀ ▶ to select “On”.
The skip is cancelled.

NOTE

You cannot cancel the skip for each group.

Check the HD Radio reception information

Press **STATUS** on the main unit while an HD Radio broadcast is being received.

The current reception information is shown on the display.

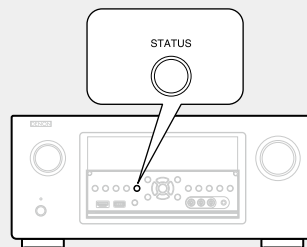

- ① Normal
- ↓
- ② Frequency / Signal strength
- ↓
- ③ Station name / Program and Program type
- ↓
- ④ Title name / Artist name
- ↓
- ⑤ Album name / Genre name

NOTE

If the station signal weakens while receiving a digital broadcast (while “HD” and text is displayed), the mode automatically switches to the analog reception mode (the reception frequency is displayed). Because of this, the “HD” and text may flicker if the station signal level is weak and unstable.

Tuner (HD Radio reception) operation buttons

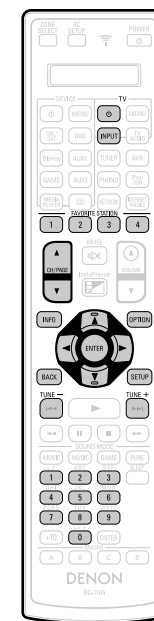

Operation buttons	Function
TV ⏻	TV power on/standby
TV INPUT	Switch TV input
FAVORITE STATION 1 – 4	Call up favorites
FAVORITE STATION 1 – 4 (Press and hold)	Add to the favorites list
CH/PAGE ▲▼	Preset channel selection
INFO	Display of information such as the source name, volume, and sound mode name
OPTION	FM/AM switching Direct frequency tuning / Preset Memory / Switch tuning modes / Auto Preset Memory / Preset Name / Preset Skip / All Zone Stereo
◀▶◁▷	Cursor operation
ENTER	Enter
BACK	Return
SETUP	Setup menu
TUNE +, –	Tuning (up/down) Multicast switching
0 – 9	Preset channel selection (1 – 8) / Direct frequency tuning (0 – 9)

Network contents

Listening to Internet Radio

Internet Radio refers to radio broadcasts distributed over the Internet. Internet Radio stations from around the world can be received.

Important information

The broadcast station types and specifications supported by this unit for playback are as follows.

[Playable broadcast station types]

Supported file types	Internet Radio
WMA (Windows Media Audio)	✓
MP3 (MPEG-1 Audio Layer-3)	✓

[Playable broadcast station specifications]

	Sampling frequency	Bit rate	Extension
WMA (Windows Media Audio)	32/44.1/48 kHz	48 – 192 kbps	.wma
MP3 (MPEG-1 Audio Layer-3)	32/44.1/48 kHz	32 – 320 kbps	.mp3

Listening to Internet Radio

1 Prepare for playback.

- ① Check the network environment, then turn on this unit's power (see [page 31](#) "Connecting to a home network (LAN)").
- ② If settings are required, make the "Settings" (see [page 148](#)).

2 Press NETWORK.

- You can also press **INTERNET RADIO** to select the input source "Internet Radio" directly.

3 Use Δ ∇ \triangleleft \triangleright to select "Internet Radio", then press ENTER.

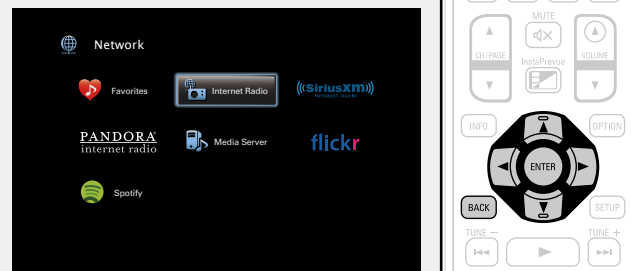

4 Use Δ ∇ to select the item you want to play, then press ENTER or \triangleright .



- **** (Country name)** Displays typical Internet Radio stations your country.
- Search Stations** Displays all Internet Radio stations that this unit can tune in to.
- Search Podcasts** Displays Internet Radio stations in the podcasts that this unit can tune in to.
- Recommended Stations** Displays recommended Internet Radio stations.
- radiodnon.com** Displays Internet Radio stations added to favorites in vTuner. For instructions on how to add to favorites in vTuner, see "Using vTuner to add Internet Radio stations to favorites" (see [page 61](#)).
- Recently Played** Displays recently played Internet Radio stations. Up to 20 stations stored in "Recently Played".
- Search by Keyword** Displays Internet Radio stations searched by keyword. For character input, see [page 118](#).

5 Repeat step 4 until the station list is displayed. The station list is displayed.

6 Use Δ ∇ to select the station, then press ENTER or \triangleright . Playback starts once buffering reaches "100%".

❑ Adjusting the sound quality (Restorer)

Make this setting at "Restorer" ([page 124](#)) in the menu.

You can use the "Restorer" function to restore to a state close to the audio before compression while correcting the bass feel to enjoy a richer playback experience. The default setting is "Mode 3 (Low)".

❑ Switching the screen display

Press **STATUS** on the main unit.

The display switches between track title and radio station name etc. each time the button is pressed.

❑ Going back to the previous screen

Press **◀** or **BACK**.

❑ Changing the screen display duration

Make this setting at "Now Playing" ([page 133](#)) in the menu. The default setting is "Always On".

When "Auto Off" is set, the on-screen display is turned off 30 seconds after an operation.

Press **△▽◀▶** while the display is off to return to the original screen.



- There are many Internet Radio stations on the Internet, and the quality of the programs they broadcast as well as the bit rate of the tracks varies widely. Generally, the higher the bit rate, the higher the sound quality, but depending on the communication lines and server traffic, the music or audio signals being streamed may be interrupted. Inversely, lower bit rates mean a lower sound quality but less tendency for the sound to be interrupted.
- "Radio station server full" or "Connection down" is displayed if the station is busy or not broadcasting.
- On this unit, folder and file names can be displayed as titles. Any characters that cannot be displayed are replaced with "." (period).

NOTE

The radio station database service may be suspended without notice.

Operations available through the OPTION button

Press the **OPTION** button to display a menu of functions that can be used on the TV screen. Select the function you want to use from this menu. You can easily find and use the desired function.

❑ **Searching content with keywords (Text Search)** ([page 76](#))

❑ **Add to favorites from the Option menu (Save to Favorites)** ([page 78](#))

❑ **Playing back music and a favorite picture at the same time (Slideshow)** ([page 79](#))

❑ **Adjusting the picture quality for your viewing environment (Picture Mode)** ([page 80](#))

❑ **All Zone Stereo function** ([page 80](#))

❑ Playing the last played Internet Radio station

This unit memorizes the last played Internet Radio station. If you press **INTERNET RADIO** to switch to the Internet Radio function from another input source, the last Internet Radio station you listened to is played.

Press INTERNET RADIO.

The source switches to "Internet Radio" and the last played radio station plays.

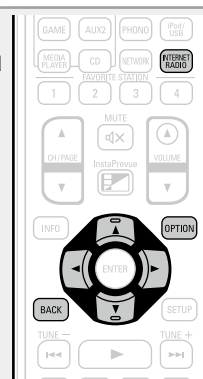

❑ Using vTuner to add Internet Radio stations to favorites

There are many Internet Radio stations in the world, and this unit can tune into these stations. But finding the radio station you want to hear may be difficult, because there are too many stations. If this is the case, then please use vTuner, an Internet Radio station search website specifically designed for this unit. You can use your PC to search Internet Radio stations and add them as your favorites. This unit can play radio stations added to vTuner.

1 Check the MAC address of this unit (☞ page 147).

The screen that lets you edit the preset name is displayed.

MAC address:

- The MAC address is necessary when you create an account for vTuner.

2 Use your PC to access the vTuner website (<http://www.radiodenon.com>).

The vTuner login screen is displayed.

3 Enter the MAC address of this unit, then click “Go”.

The account creation screen is displayed.

4 Enter your E-mail address and a password of your choice.

The account is registered and you can now log in.

5 Enter your account information (E-mail address and password) and log in.

The top menu of vTuner is displayed.

6 Select the search criteria (genre, region, language, etc.) of your choice.

The list of radio stations matching the criteria is displayed.

- You can also enter a keyword to search for a station you want to hear.

7 Select the radio station of your choice from the list, and then click the Add to Favorites icon.

The screen that lets you create a favorite group is displayed.

8 Enter the name of the favorite group, then click “Go”.

A new favorite group that includes the selected radio station is created.

- Internet Radio stations added to favorites in vTuner can be played from “radiodenon.com” (☞ page 59) with this unit.

❑ Internet Radio operation buttons



Operation buttons	Function
TV	TV power on/standby
TV INPUT	Switch TV input
INTERNET RADIO	Last played Internet Radio station
FAVORITE STATION 1 – 4	Call up favorites
FAVORITE STATION 1 – 4 (Press and hold)	Add to the favorites list
CH/PAGE	Page search
INFO	Display of information such as the source name, volume, and sound mode name
OPTION	Text Search / Save to Favorites / Slideshow / Picture Mode / All Zone Stereo
	Cursor operation
ENTER (Press and release)	Enter
ENTER (Press and hold)	Stop
BACK	Return
SETUP	Setup menu
	Stop

Playing back files stored on a PC and NAS

This unit can play back music files and playlists (m3u, wpl) stored on a PC and on Network Attached Storage (NAS) that supports DLNA.

Important information

- The network audio playback function of this unit connects to the server using technologies shown below.
 - Windows Media Player Network Sharing Service
 - Windows Media DRM10
- File types that this unit can play back and specifications are shown below.

[Supported file types]

Supported file types	Media Server *1
WMA (Windows Media Audio)	✓
MP3 (MPEG-1 Audio Layer-3)	✓
WAV	✓
MPEG-4 AAC	✓*2
FLAC (Free Lossless Audio Codec)	✓
JPEG	✓
ALAC (Apple Lossless Audio Codec)	✓

A server or server software compatible with distribution in the corresponding formats is required to play music files via a network.

*1 Media Server

- This unit is compatible with MP3 ID3-Tag (Ver. 2) standard.
- This unit can show the artwork that was embedded by using MP3 ID3-Tag Ver. 2.3 or 2.4.
- This unit is compatible with WMA META tags.
- If the image size (pixels) of an album artwork exceeds 500 × 500 (WMA/MP3/WAV/FLAC) or 349 × 349 (MPEG-4 AAC), then music may not be played back properly.
- WAV format Quantization bit length: 16 or 24 bits.
- FLAC format Quantization bit length: 16 or 24 bits.

*2 Only files that are not protected by copyright can be played on this unit.

Content downloaded from pay sites on the Internet are copyright protected. Also, files encoded in WMA format when ripped from a CD, etc. on a computer may be copyright protected, depending on the computer's settings.

NOTE

File types that this unit does not support are not displayed.

[Specifications of supported files]

	Sampling frequency	Bit rate	Extension
WMA (Windows Media Audio)	32/44.1/48 kHz	48 – 192 kbps	.wma
MP3 (MPEG-1 Audio Layer-3)	32/44.1/48 kHz	32 – 320 kbps	.mp3
WAV	32/44.1/48/88.2/96/ 176.4/192 kHz	–	.wav
MPEG-4 AAC	32/44.1/48 kHz	16 – 320 kbps	.aac/ .m4a/ .mp4
FLAC (Free Lossless Audio Codec)	32/44.1/48/88.2/96/ 176.4/192 kHz	–	.flac
ALAC (Apple Lossless Audio Codec)*	32/44.1/48/88.2/96 kHz	–	.m4a

* Copyright [2012] [D&M Holdings, Inc.]

Licensed under the Apache License, Version 2.0 (the "License"); you may not use this file except in compliance with the License. You may obtain a copy of the License at <http://www.apache.org/licenses/LICENSE-2.0>

Applying media sharing settings

Here, we apply the settings to share music files stored on a PC and NAS on the network.

Sharing media stored in PC

If you are using a Media Server, be sure to apply this setting first.

When using Windows Media Player 12 (Windows 7)

NOTE

Perform this procedure after changing the control panel display to "Category".

- 1** In the PC's "Control Panel", select "Network and Internet" - "Choose homegroup and sharing options".
- 2** Select the "Stream my pictures, music, and videos to all devices on my home network" check box and select "Choose media streaming options".
- 3** Select "Allowed" in the drop-down list for "AVR-4520CI".
- 4** Select "Allowed" in the drop-down list for "Media programs on this PC and remote connections...".
- 5** Click "OK" to finish.

When using Windows Media Player 11

- 1** Start up Windows Media Player 11 on the PC.
- 2** Select "Media Sharing" in the "Library".
- 3** Click the "Share my media" check box, select "AVR-4520CI", and then click "Allow".
- 4** As you did in step 3, select the icon of the device (other PCs and mobile devices) you want to use as a media controller, and then click "Allow".
- 5** Click "OK" to finish.

Sharing media stored in NAS

Change settings on the NAS to allow this unit and other devices (PCs and mobile devices) used as media controllers to access the NAS. For details, see the owner's manual that came with the NAS.

Playing back files stored on a PC and NAS

Use this procedure to play music files, image files or playlists.

1 Prepare for playback.

- ① Check the network environment, then turn on this unit's power (☞ [page 31](#) "Connecting to a home network (LAN)").
- ② If settings are required, make the "Settings" (☞ [page 148](#)).
- ③ Prepare the computer (☞ Computer's operating instructions).

2 Press NETWORK.

3 Use $\Delta \nabla \triangleleft \triangleright$ to select "Media Server", then press ENTER.

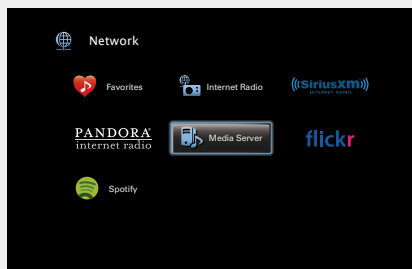

4 Use $\Delta \nabla$ to select the server including the file to be played, then press ENTER or \triangleright .

5 Use $\Delta \nabla$ to select the search item or folder, then press ENTER or \triangleright .

6 Repeat step 4 until the file is displayed.

7 Use $\Delta \nabla$ to select the file, then press ENTER or \triangleright . Playback starts once buffering reaches "100%".

Adjusting the sound quality (Restorer)

Make this setting at "Restorer" (☞ [page 124](#)) in the menu.

You can use the "Restorer" function to restore to a state close to the audio before compression while correcting the bass feel to enjoy a richer playback experience. The default setting is "Mode 3 (Low)".

Switching the screen display

Press **STATUS** on the main unit.

The display switches between track title, artist name, and album title each time the button is pressed.

Going back to the previous screen

Press \triangleleft or **BACK**.

Changing the screen display duration

Make this setting at "Now Playing" (☞ [page 133](#)) in the menu. The default setting is "Always On".

When "Auto Off" is set, the on-screen display is turned off 30 seconds after an operation.

Press $\Delta \nabla \triangleleft \triangleright$ while the display is off to return to the original screen.



- When a WMA (Windows Media Audio), MP3 or MPEG-4 AAC file includes album art data, the album art can be displayed while the music files are playing.
- If you use Ver.11 or later of Windows Media Player, the album art for WMA files can be displayed.
- WMA Lossless files can be played when using a server supporting transcoding, such as Windows Media Player Ver. 11 or later.

NOTE

- Depending on the size of the still picture (JPEG) file, some time may be required for the file to be displayed.
- The order in which the tracks/files are displayed depends on the server specifications. If the tracks/files are not displayed in alphabetical order due to the server specifications, searching by the first letter may not work properly.

Operations available through the OPTION button

Press the **OPTION** button to display a menu of functions that can be used on the TV screen. Select the function you want to use from this menu. You can easily find and use the desired function.

❑ **Searching content with keywords (Text Search)** (🔗 page 76)

❑ **Performing repeat playback (Repeat)** (🔗 page 77)

❑ **Performing random playback (Random)** (🔗 page 77)

❑ **Add to favorites from the Option menu (Save to Favorites)** (🔗 page 78)

❑ **Playing back music and a favorite picture at the same time (Slideshow)** (🔗 page 79)

❑ **Playing back still images in sequential order (Slideshow Interval)** (🔗 page 79)

❑ **Adjusting the picture quality for your viewing environment (Picture Mode)** (🔗 page 80)

❑ **All Zone Stereo function** (🔗 page 80)

❑ Media Server operation buttons

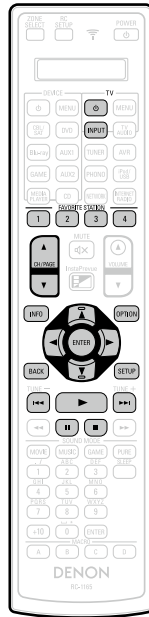

Operation buttons	Function
TV	TV power on/standby
TV INPUT	Switch TV input
FAVORITE STATION 1 – 4	Add/call up favorites
FAVORITE STATION 1 – 4 (Press and hold)	Add to the favorites list
CH/PAGE	Page search
INFO	Display of information such as the source name, volume, and sound mode name
OPTION	Text Search / Repeat playback / Random playback / Save to Favorites / Slideshow / Slideshow Interval / Picture Mode / All Zone Stereo
	Cursor operation / Auto search (cue,)
ENTER (Press and release)	Enter
ENTER (Press and hold)	Stop
BACK	Return
SETUP	Setup menu
	Auto search (cue)
	Playback / Pause
	Pause
	Stop

Using online services

This unit supports playback of the online services shown below.

□ About Flickr (👉 [page 67](#))

Flickr is an online photograph sharing service that started in 2004. You can use this unit to view photographs that have been made public by Flickr users. You do not need an account to use Flickr. To view photographs that you recorded yourself, you need an account in order to upload these photographs to the Flickr server. For details, see the Flickr homepage.
<http://www.flickr.com/>

□ About Pandora® (👉 [page 69](#))

Pandora is an automated music recommendation and Internet Radio service created by the Music Genome Project. To listen to Pandora you will need a free Pandora account. If you do not have a Pandora account, you can create one at www.pandora.com or from the Pandora smartphone application. It is necessary to associate this machine with a Pandora account by visiting <http://www.pandora.com/denon> from your PC.

□ About SiriusXM (👉 [page 72](#))

Enjoy anywhere access to the unparalleled content of SiriusXM. Whether on your computer, smartphone, tablet, Lynx Portable Enjoy anywhere access to the unparalleled content of SiriusXM. Whether on your computer, smartphone, tablet, Lynx Portable Radio, or compatible Internet-connected device, you don't need to be in your vehicle to enjoy SiriusXM. For details, see the SiriusXM homepage.
<http://www.siriusxm.com>

□ About Spotify (👉 [page 74](#))

Introduce your DENON to a whole new world of music. With Spotify, you can enjoy instant access to millions of songs. A Spotify Premium subscription is required. For details, see the Spotify homepage.
<http://www.spotify.com>

Viewing photographs on the Flickr site

You can view photographs shared by particular users, or all of the photographs shared on Flickr.

Viewing photographs shared by particular users

1 Prepare for playback.

- ① Check the network environment, then turn on this unit's power (☞ [page 31](#) "Connecting to a home network (LAN)").
- ② If settings are required, make the "Settings" (☞ [page 148](#)).

2 Press NETWORK.

3 Use $\Delta \nabla \triangleleft \triangleright$ to select "Flickr", then press ENTER.

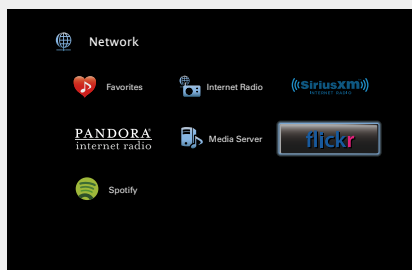

4 Use $\Delta \nabla$ to select "Add Flickr Contact", then press ENTER or \triangleright .

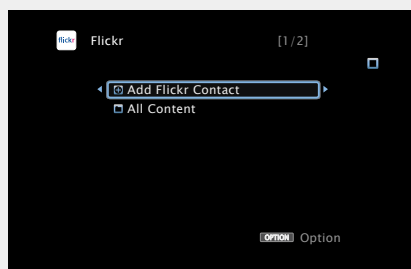

5 In "Contact", add the screen name (user name you want to view) you want to add.

- For character input, see [page 118](#).

6 After inputting the "Contact", press **OK**.

The screen name is added to "Contact", and the screen name you entered in Step 5 is displayed on the top screen of Flickr.

- If you enter a screen name that does not exist, "The Flickr Contact you entered could not be found" is displayed. Check and enter the correct screen name.

7 Use $\Delta \nabla$ to select the folder, and then press ENTER or \triangleright .

Favorites	Displays the favorite photographs of the specified user.
Photostream	Displays a list of shared photographs.
PhotoSets	Displays the folder (photograph album) list.
Contacts	Displays the screen name used by the specified user in Contacts.
Remove this Contact	Deletes a user from Flickr Contact.
Add this Contact	Adds a user from Flickr Contact.

8 Use $\Delta \nabla$ to select the file, and then press ENTER or \triangleright .

The selected file is displayed.

Going back to the previous screen

Press \triangleleft or **BACK**.

Operations available through the OPTION button

Press the **OPTION** button to display a menu of functions that can be used on the TV screen. Select the function you want to use from this menu. You can easily find and use the desired function.

Playing back still images in sequential order (Slideshow Interval) (☞ [page 79](#))

❑ Viewing all photographs on Flickr

1 Use Δ / ∇ to select “All Content”, then press **ENTER** or \triangleright .



2 Use Δ / ∇ to select the folder, and then press **ENTER** or \triangleright .

Interestingness Displays photographs that are popular from the number of user comments or number of times they are added as favorites.

Recent Displays the most recently added photographs.

Search by text Search for photographs by keyword.

3 Use Δ / ∇ to select the file, and then press **ENTER** or \triangleright .
The selected file is displayed.

NOTE

Depending on the file format, some photographs cannot be viewed.

❑ Flickr operation buttons

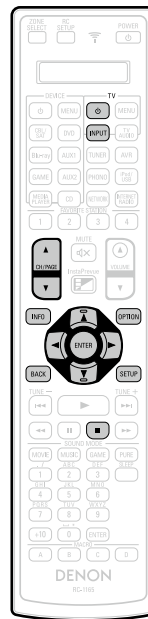

Operation buttons	Function
TV ⏻	TV power on/standby
TV INPUT	Switch TV input
CH/PAGE $\blacktriangle/\blacktriangledown$	Page search
INFO	Display of information such as the source name, volume, and sound mode name
OPTION	Slideshow Interval
Δ / ∇ / \leftarrow / \rightarrow	Cursor operation / Auto search (cue, Δ / ∇)
ENTER (Press and release)	Enter
ENTER (Press and hold)	Stop
BACK	Return
SETUP	Setup menu
\blacksquare	Stop

Listening to Pandora®

1 Prepare for playback.

- ① Check the network environment, then turn on this unit's power (☞ [page 31](#) "Connecting to a home network (LAN)").
- ② If settings are required, make the "Settings" (☞ [page 148](#)).
- ③ Complete step 4 and obtain a Pandora account.
 - If you already have a Pandora account, you do not need to obtain a new account. Use your existing Pandora account.

2 Press NETWORK.

3 Use $\Delta \nabla \triangleleft \triangleright$ to select "Pandora", then press ENTER.

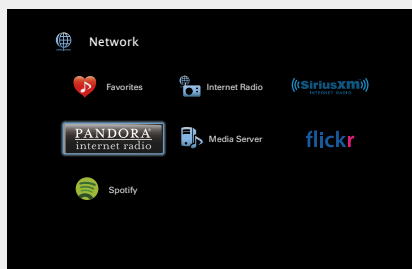

4 If you have a Pandora account, use $\Delta \nabla$ to select "I have a Pandora account", then press ENTER or \triangleright .

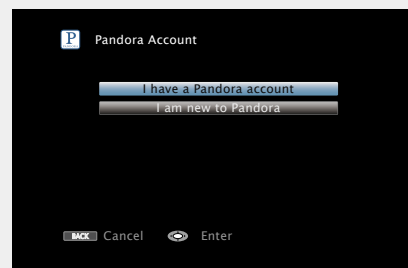

- If you do not have a Pandora account, press ∇ to select "I am new to Pandora". The URL of Pandora and activation code are displayed. Access the Pandora web page from your PC and register the displayed activation code and account information. Then press ENTER.

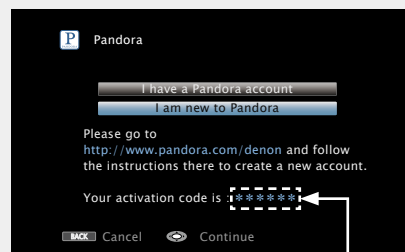

This is an identification code required to register your purchased product to the Pandora service.
This code is used to obtain your account.

5 Input "Email address" and "Password".

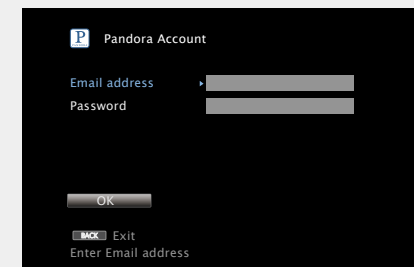

- For character input, see [page 118](#).

6 After inputting the "Email address" and "Password", select "OK", then press ENTER.

If the "Email address" and "Password" match, the top menu for Pandora is displayed.

NOTE

Press **BACK** to cancel the input. When "Cancel input?" is displayed, select "Yes", then press **ENTER**.

❑ Creating a new station

You can create up to 100 radio stations.

- 1** Use Δ / ∇ to select “New Station”, then press **ENTER** or \triangleright .



- 2** Input a track or artist name, then press **OK**.

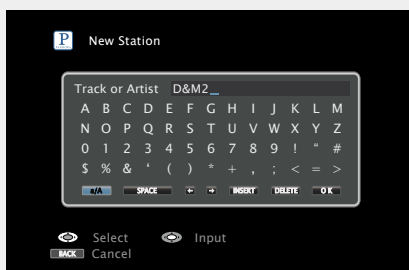

- For character input, see [page 118](#).

- 3** Use Δ / ∇ to select “Search by Artist” or “Search by Track”, then press **ENTER**.

You can search and display a list by track or artist.

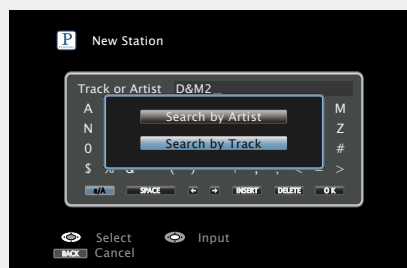

- 4** Press Δ / ∇ , select a file (e.g. D&M2) from the list, and press **ENTER** or \triangleright .

“Radio” is added to the end of a filename, and your new station is created (e.g. D&M2 Radio).



- Your new station will play music with similar qualities to the artist or track you entered.

❑ Listening to an existing station

Use Δ / ∇ and select the radio station (“D&M2 Radio”) that you want to listen to, and press **ENTER** or \triangleright .

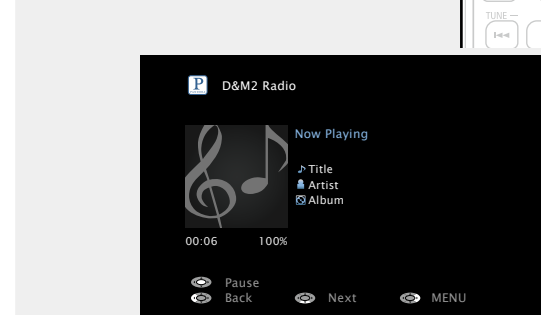

Listening to created radio stations at random

Use Δ / ∇ to select “Quick Mix”, then press **ENTER** or \triangleright .

Created radio stations are selected at random, and tracks are streamed.

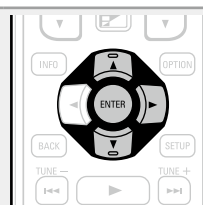

□ Giving Feedback and Managing Stations

You can personalize your stations by providing feedback.

Press **▷** while a track is playing.

The Pandora menu screen is displayed.

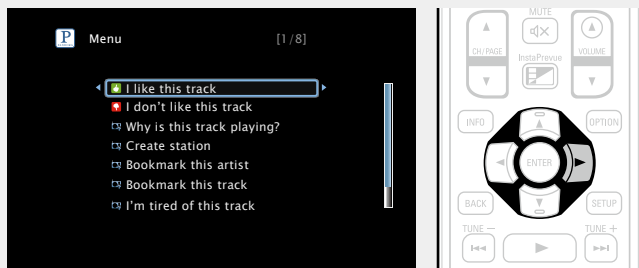

I like this track

- Press when you like the track that is being played.
- It will return to the Play Screen. And (Thumbs up) icon is displayed. (The icon is not displayed on the next track.)

I don't like this track

- Press when you don't like the track that is being played.
- It will return to the Play Screen. And (Thumbs down) icon is displayed. (The icon is not displayed on the next track.)

Why is this track playing?

- Displays the reason why Pandora selected this track.

Create station

- Creates a Station for the Track or Artist being played.

Bookmark this artist

- Bookmarks the artist currently being played.
- You can check on a computer or iPhone etc.
- For details, see the Pandora web page.

Bookmark this track

- Bookmarks the track currently being played.
- You can check on a computer or iPhone etc.
- For details, see the Pandora web page.

I'm tired of this track

- Press when you don't like the track that is being played.
- The track will not be played for 1 month.

Delete this station

- Press when you want to delete the station that is being played.

NOTE

- You can Skip up to 6 Tracks that are being played back within 1 hour.
- You can create up to 100 Stations (radio stations).

□ Sign out

Disassociate this unit from your Pandora account.

1 While the Pandora top menu is displayed, press **BACK**.



2 When the popup menu appears, use **◀ ▶** to select "Yes", then press **ENTER**.

□ Pandora operation buttons



Operation buttons	Function
CH/PAGE ▲▼	Page search
INFO	Display of information such as the source name, volume, and sound mode name
△▽◀▶	Cursor operation / Auto search (cue, ▽)
ENTER (Press and release)	Enter
ENTER (Press and hold)	Stop
BACK	Return
SETUP	Setup menu
▶	Playback
▶▶	Skips the current track, subject to skip limit
⏸	Pause
■	Stop

Listening to SiriusXM Internet Radio

Over 120 channels of the SiriusXM programming you love, including commercial-free music plus sports, talk, news and entertainment. Listen anywhere on your computer or smartphone.

1 Prepare for playback.

- ① Check the network environment, then turn on this unit's power (see [page 31](#) "Connecting to a home network (LAN)").
- ② If settings are required, make the "Settings" (see [page 148](#)).
- ③ Access the following website from your PC and obtain a SiriusXM account.
<http://www.siriusxm.com>
 - If you already have a SiriusXM account, you do not need to obtain a new account. Select "Sign in" in step 4, and enter your existing SiriusXM account.

2 Press NETWORK.

3 Use Δ ∇ \triangleleft \triangleright to select "SiriusXM", then press ENTER.

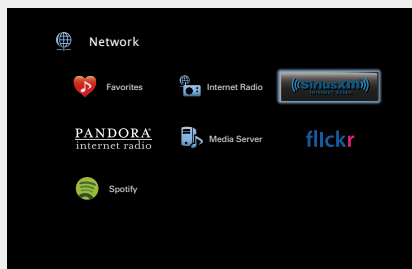

4 Select "Sign in", then press ENTER.

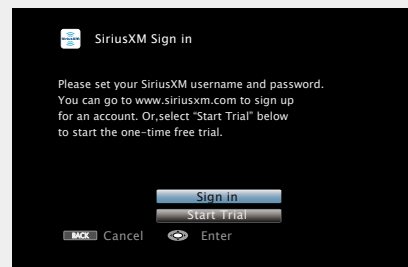

5 Input the "Username" and "Password".

- For character input, see [page 118](#).

6 Select the "Sign in", and then press ENTER.

The top menu of SiriusXM is displayed.

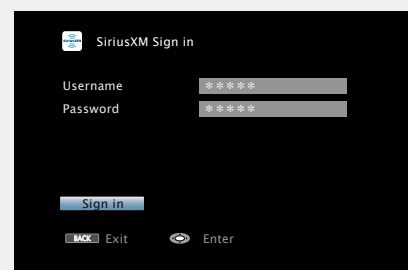

7 Use Δ ∇ to select the genre, then press ENTER or \triangleright .

8 Use Δ ∇ to select the file, and then press ENTER or \triangleright .

The selected file is displayed.

Going back to the previous screen

Press \triangleleft or BACK.

❑ Sign out

Disassociate this unit from your SiriusXM account.

- 1** While the SiriusXM top menu is displayed, press **BACK**.
- 2** When the popup menu appears, use **◀ ▶** to select “Yes”, then press **ENTER**.



❑ SiriusXM operation buttons

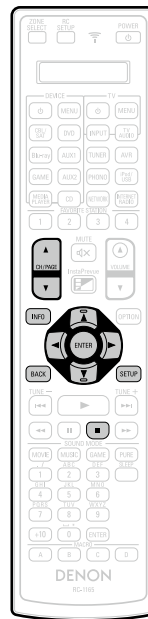

Operation buttons	Function
CH/PAGE ▲▼	Page search
INFO	Display of information such as the source name, volume, and sound mode name
◀▼▶▶	Cursor operation
ENTER (Press and release)	Enter
ENTER (Press and hold)	Stop
BACK	Return
SETUP	Setup menu
■	Stop

Listening to Spotify

Introduce your DENON to a whole new world of music. With Spotify, you can enjoy instant access to millions of songs.

A Spotify Premium subscription is required.

For details, see the Spotify homepage.

<http://www.spotify.com>

1 Prepare for playback.

- ① Check the network environment, then turn on this unit's power (see [page 31](#) "Connecting to a home network (LAN)").
- ② If settings are required, make the "Settings" (see [page 148](#)).
- ③ Complete step 5 and obtain a Spotify account.
 - If you already have a Spotify account, you do not need to obtain a new account. Use your existing Spotify account.

2 Press NETWORK.

3 Use $\Delta \nabla \triangleleft \triangleright$ to select "Spotify", then press ENTER.

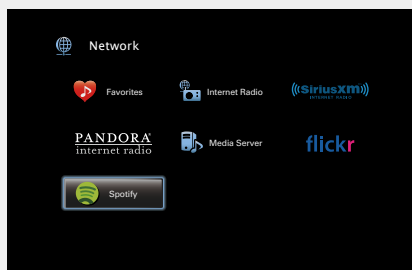

4 If you have a Spotify account, then press ENTER.

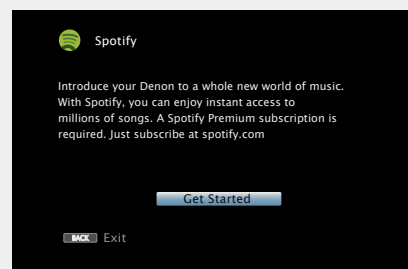

5 Use $\Delta \nabla \triangleright$ to enter your username and password.

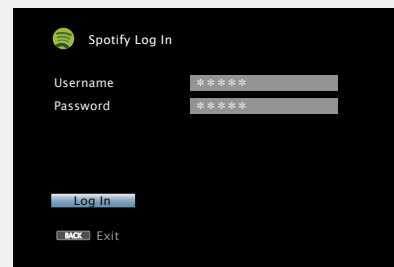

- The password should be no longer than 99 characters. For character input, see [page 118](#).
- The types of characters that can be input are as shown below.

[Upper case characters/Numbers/Symbols]
 ABCDEFGHIJKLMNOPQRSTUVWXYZ
 ÅÄÅÅÅÅÆÇÐÈÉÊËÌÍÎÏÑÒÓÔÕÖØÙÚÛÜÝÞ
 0123456789
 ! " # \$ % & ' () * + , ; < = >
[Lower case characters/Numbers/Symbols]
 abcdefghijklmnopqrstuvwxyz
 åäååååæçðèéêëìíîïñòóôõöøùúûüýþÿß
 0123456789
 . @ - _ / : ~ ? [\] ^ ' { | }

- When you use $\Delta \nabla$ while you type in, you can change uppercase characters to lowercase and vice versa.
- Press **BACK** to cancel the input. When "Cancel input?" is displayed, select "Yes", then press **ENTER**.

6 After inputting the username and password, select "Log In", then press ENTER.

If the username and password match, the top menu for Spotify is displayed.

7 Use $\Delta \nabla$ to select menu and then press ENTER.

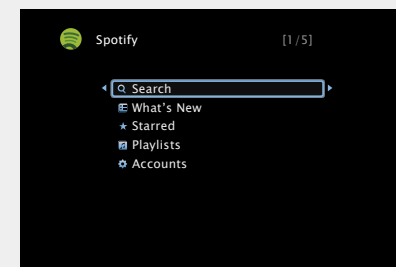

Search Searches for tracks, artists and albums by entering keywords.

What's New Displays the list of the latest albums.

Starred Displays the list of the starred tracks.

Playlists Displays the playlists for Spotify.

Accounts Manages accounts (Log out, Add new user, Switch to user).

8 Use $\Delta \nabla$ to select a station, and press ENTER or \triangleright to start playback.

Playback starts and the following screen appears.

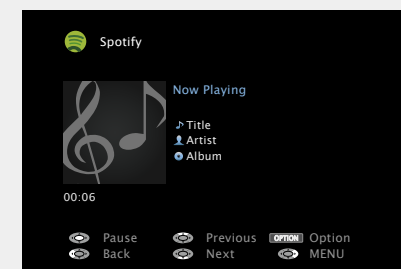

9 Menu items on playback screen.

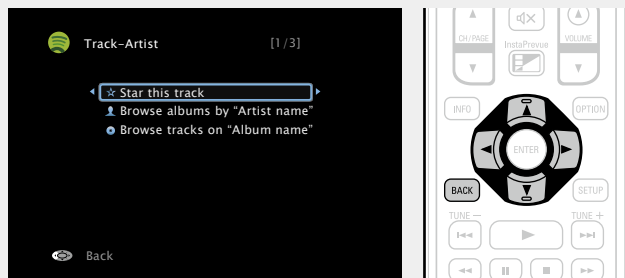

Star this track Adds a star to the selected track.

Browse albums by "Artist name" Displays the list of albums by the artist of the track that is being played back.

Browse tracks on "Album name" Displays the list of tracks on the album that is being played back.

Adjusting the sound quality (Restorer)

Make this setting at "Restorer" ([page 124](#)) in the menu.

You can use the "Restorer" function to restore to a state close to the audio before compression while correcting the bass feel to enjoy a richer playback experience. The default setting is "Mode 3 (Low)".

Switching the screen display

Press **STATUS** on the main unit.

The display switches between track title, artist name, and album title each time the button is pressed.

Going back to the previous screen

Press \triangleleft or **BACK**.

Changing the screen display duration

Make this setting at "Now Playing" ([page 133](#)) in the menu. The default setting is "Always On".

When "Auto Off" is set, the on-screen display is turned off 30 seconds after an operation.

Press $\triangleleft \triangleright$ while the display is off to return to the original screen.

Operations available through the OPTION button

Press the **OPTION** button to display a menu of functions that can be used on the TV screen. Select the function you want to use from this menu. You can easily find and use the desired function.

Performing repeat playback (Repeat)

([page 77](#))

Performing random playback (Random)

([page 77](#))

All Zone Stereo function ([page 80](#))

Spotify operation buttons



Operation buttons	Function
CH/PAGE $\blacktriangle \blacktriangledown$	Page search
INFO	Display of information such as the source name, volume, and sound mode name
OPTION	Repeat playback / Random playback / All Zone Stereo
$\triangle \triangleright \triangleleft \triangleright$	Cursor operation / Auto search (cue, $\triangle \triangleright$)
ENTER (Press and release)	Enter
ENTER (Press and hold)	Stop
BACK	Return
SETUP	Setup menu
$\blacktriangleleft \blacktriangleright$	Auto search (cue)
\blacktriangleright	Playback
II	Pause
\blacksquare	Stop

Convenient functions

Here, we explain how to use convenient functions for NETWORK sources and USB sources. The source names under the titles of each function's description are sources that allow use of these functions.

❑ Setting the USB port to use (USB Select)

([page 76](#))

❑ Searching content with keywords

([Text Search](#)) ([page 76](#))

❑ Performing repeat playback (Repeat)

([page 77](#))

❑ Performing random playback (Random)

([page 77](#))

❑ Favorites function

([page 78](#))

❑ Playing back music and a favorite picture at the same time (Slideshow)

([page 79](#))

❑ Playing back still images in sequential order (Slideshow Interval)

([page 79](#))

❑ Adjusting the picture quality for your viewing environment (Picture Mode)

([page 80](#))

❑ All Zone Stereo function

([page 80](#))

Setting the USB port to use (USB Select)

iPod **USB**

1 Press **OPTION**.
The option menu screen is displayed.

2 Use Δ/∇ to select "USB Select", then press **ENTER**.

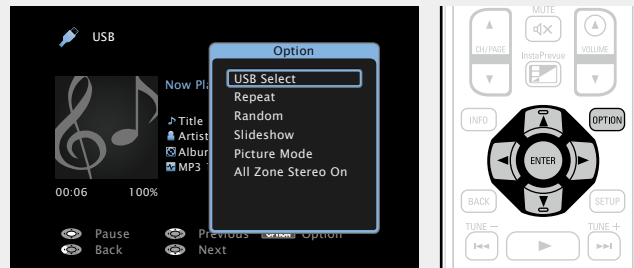

3 Use $\triangleleft/\triangleright$ to select the USB port to use.

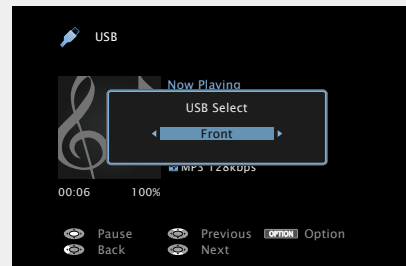

• Each time $\triangleleft/\triangleright$ is pressed, the setting is changed as shown below.

Front \longleftrightarrow Rear

Front Uses the USB port on the front panel.

Rear Uses the USB port on the rear panel.

4 Press **ENTER**.
The display returns to the playback screen.

Searching content with keywords (Text Search)

USB **Internet Radio** **Media Server**

1 While content is playing, press **OPTION**.
The option menu screen is displayed.

2 Use Δ/∇ to select "Text Search", then press **ENTER**.
The keyboard input screen is displayed.

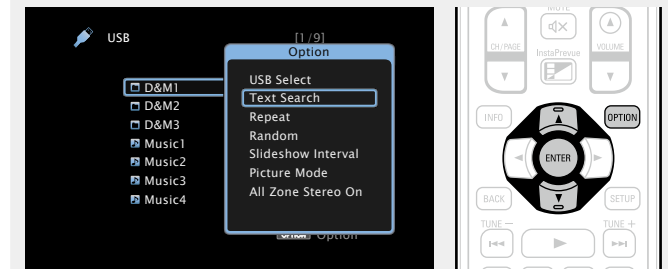

3 Enter the first character of the Internet Radio station or file you want to search for, and then press **OK**.

• For character input, see [page 118](#).



"Text Search" searches for Internet Radio stations or files that start with the entered first character from the displayed list.

NOTE

"Text Search" may not work for some lists.

❑ Playing back a search result content

Use Δ/∇ to select the content you want to play, and then press **ENTER** or \triangleright .

Playback starts.



Performing repeat playback (Repeat)

USB Media Server

1 While content is playing, press **OPTION**.
The option menu screen is displayed.

2 Use Δ / ∇ to select "Repeat", then press **ENTER**.

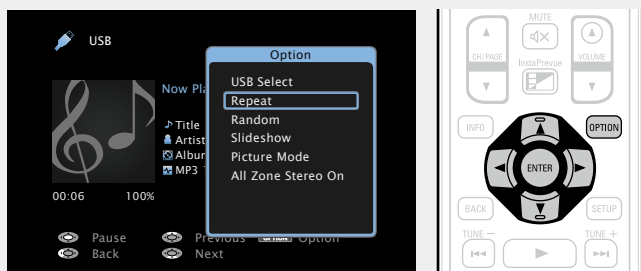

3 Use \triangleleft / \triangleright to select repeat playback mode.

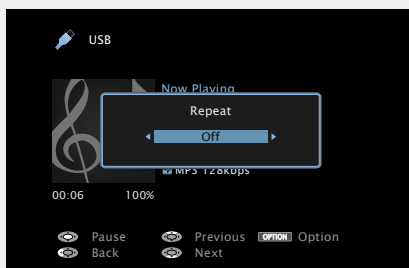

• Each time \triangleleft / \triangleright is pressed, the setting is changed as shown below.

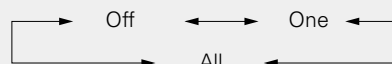

Off Repeat playback mode is canceled.

One A file being played is played repeatedly.

All All files in the folder currently being played are played repeatedly.

4 Press **ENTER**.
The display returns to the playback screen.

Performing random playback (Random)

USB Media Server

1 While content is playing, press **OPTION**.
The option menu screen is displayed.

2 Use Δ / ∇ to select "Random", then press **ENTER**.

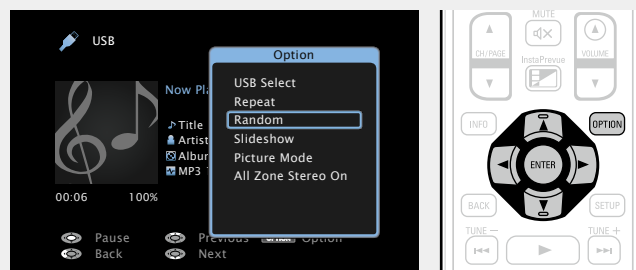

3 Use \triangleleft / \triangleright to select random playback mode.

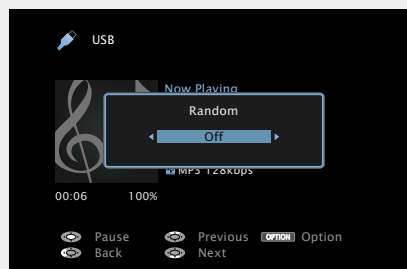

• Each time \triangleleft / \triangleright is pressed, the setting is changed as shown below.

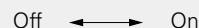

Off Disable random playback.

On Enable random playback.

4 Press **ENTER**.
The display returns to the playback screen.



The random playback randomly selects a track to play back from all tracks every time a track ends. Therefore, the same track may be played back consecutively.

Favorites function

There are two ways to add content to favorites:

- ① Add to favorites from the Option menu
- ② Add to the **FAVORITE STATION** button

❑ Add to favorites from the Option menu (Save to Favorites)

Internet Radio **Media Server**

You can add up to 100 items as favorites for all sources (Internet Radio and Media Server).

1 While content is playing, press **OPTION**.

The option menu screen is displayed.

2 Use $\Delta \nabla$ to select “Save to Favorites”, then press **ENTER**.

“Favorite added” is displayed, and the current content is added to favorites.

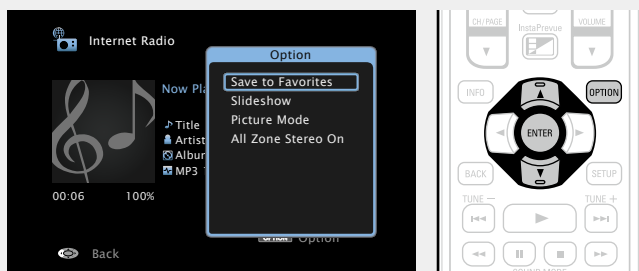

- The display returns to the playback screen when the procedure is completed.

Playing back content added in “Save to Favorites”

1 Press **NETWORK**.

2 Use $\Delta \nabla \triangleleft \triangleright$ to select “Favorites”, then press **ENTER**.

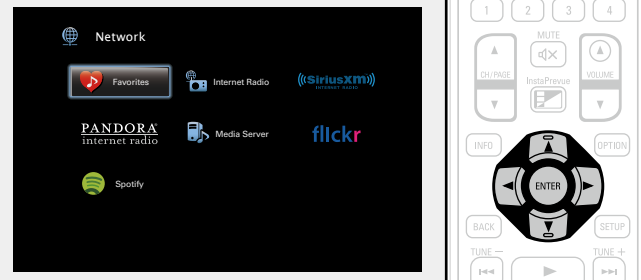

3 Use $\Delta \nabla$ to select the content you want to play, and then press **ENTER** or \triangleright . Playback starts.

❑ Adding to the **FAVORITE STATION** button

You can add up to four types of content.

NOTE

- Please note that if you add new content to a number that already contains content, the older content is deleted.
- The following operations update the database on the Media Server, which may make the added music files unplayable.
 - When you quit the Media Server and then restart it.
 - When music files are deleted or added on the Media Server.
- When using an ESCIENT server, place “ESCIENT” before the server name.

While content is playing, press and hold one of the **FAVORITE STATION 1 – 4** buttons for more than 3 seconds.

The content is added to the button you pressed.

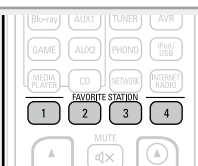

Contents that can be added to the **FAVORITE STATION** button differ depending on the input source.

Input source	Contents that can be added
FM	Radio station
Internet Radio	Top list of content / Internet Radio station
Media Server	Top list of content / Track
Flickr	Top list of content
Pandora	Top list of content
SiriusXM	Top list of content
Spotify	Top list of content
Favorites	Top list of content

Playing back content added to the **FAVORITE STATION** button

You can easily call up content by pressing the **FAVORITE STATION** button.

Press one of the **FAVORITE STATION 1 – 4** buttons that you added content to.

Playback starts.

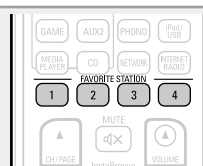

- When the **FAVORITE STATION 1 – 4** buttons is pressed, the AVR-operation mode starts automatically.
- Internet Radio stations are already registered to the **FAVORITE STATION 1 – 4** buttons. However, you may not be able to play the stations due to restrictions imposed by the radio stations.

Deleting content added to favorites (Remove from Favorites)

1 Press **NETWORK**.

2 Use $\Delta \nabla \triangleleft \triangleright$ to select "Favorites", then press **ENTER**.

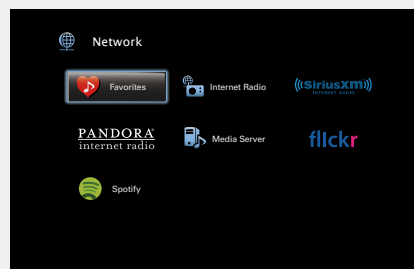

3 Use $\Delta \nabla$ to select the content you want to delete from favorites, then press **OPTION**.
The option menu screen is displayed.

4 Use $\Delta \nabla$ to select "Remove from Favorites", then press **ENTER**.
"Favorite removed" is displayed, and the selected content is deleted from favorites.

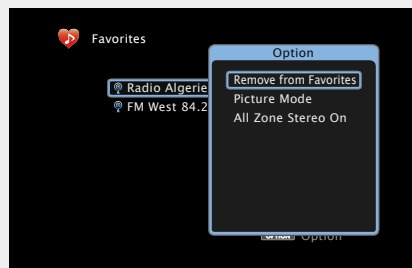

- The display returns to the original screen when the procedure is completed.

Playing back music and a favorite picture at the same time (Slideshow)

USB **Internet Radio** **Media Server**

1 Play back a still picture.

- Playing back still pictures stored on USB memory devices (page 48).
- Playing back still pictures stored on Flickr (page 67).

2 Play back a music file or Internet Radio station (page 59, 64).

3 Press **OPTION**.
The option menu screen is displayed.

4 Use $\Delta \nabla$ to select "Slideshow", then press **ENTER**.
The option menu disappears, and the picture you were viewing is shown on the screen.

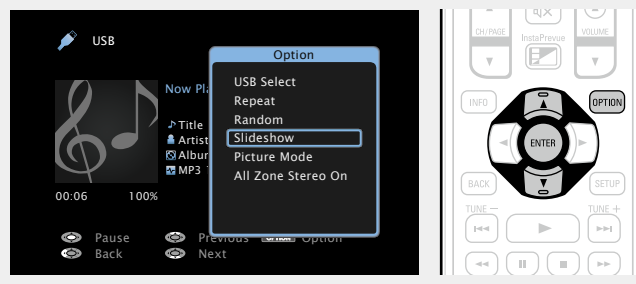

Playing back still images in sequential order (Slideshow Interval)

You can play back still image (JPEG) files stored on a USB memory device or Media Server and pictures on Flickr website as a slide show. The display time can also be set.

USB **Media Server** **Flickr**

1 Play back an image and press **OPTION**.
The option menu screen is displayed.

2 Use $\Delta \nabla$ to select "Slideshow Interval", then press **ENTER**.

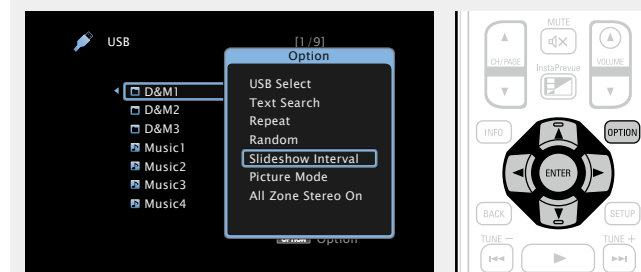

3 Use $\triangleleft \triangleright$ to set the display time.

- Each time $\triangleleft \triangleright$ is pressed, the setting is changed as shown below.

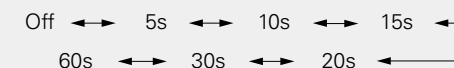

Off The slide show is not played back.

5s – 60s Set the time for displaying a single image when playing back images in the slide show.

4 Press **ENTER**.
The slide show is displayed on the screen.



This unit plays back image (JPEG) files in the orientation in which they are stored in the folder.

Adjusting the picture quality for your viewing environment (Picture Mode)

- CBL/SAT
- DVD
- Blu-ray
- GAME
- AUX1
- AUX2
- MEDIA PLAYER
- USB
- Internet Radio
- Media Server
- CD *
- TV AUDIO *

* You can set the picture mode when an HDMI, component video or video connector is assigned.

1 While content is playing, press **OPTION**.
The option menu screen is displayed.

2 Use Δ / ∇ to select "Picture Mode", then press **ENTER**.

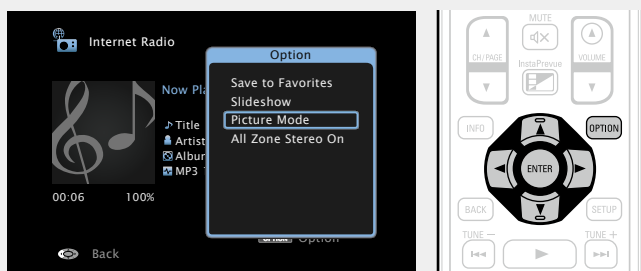

3 Use \triangleleft / \triangleright to select picture mode.

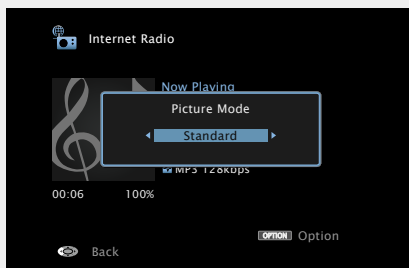

• Each time \triangleleft / \triangleright is pressed, the setting is changed as shown below.

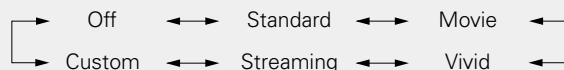

Off	No picture quality adjustment is done with this unit.
Standard	The standard mode suited for most living room viewing environments.
Movie	A mode suited for watching movies in a dark room such as a theater room.
Vivid	A mode that makes graphic images for games, etc. brighter and more vivid.
Streaming	A mode suited for low bit rate video sources.
Custom	Adjusts the picture quality manually.

4 Press **ENTER**.
The display returns to the playback screen.

All Zone Stereo function

You can play back music in multi-zones (ZONE2/ZONE3) simultaneously that is played back in MAIN ZONE.

It is useful when you want to enjoy the same music at the same time in multiple rooms during home party or when you want to play back the same BGM in the entire house.

Using the All Zone Stereo function (All Zone Stereo On)

The All Zone Stereo function can be set for any source.



Before setting this function, you need to turn on the multi-zones (ZONE2/ZONE3) for which you want to use the All Zone Stereo function.

1 Press **ZONE SELECT** to switch the zone mode.
The **M** indicator lights.

2 Press **OPTION**.
The option menu screen is displayed.

3 Use Δ / ∇ to select "All Zone Stereo On", then press **ENTER**.
The input source for the multi-zones (ZONE2/ZONE3) is switched to the same as the one for MAIN ZONE, and playback in the All Zone Stereo mode starts.

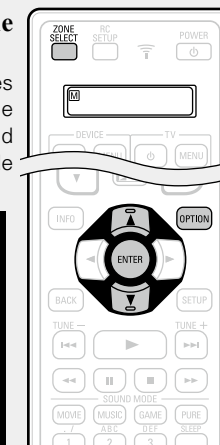
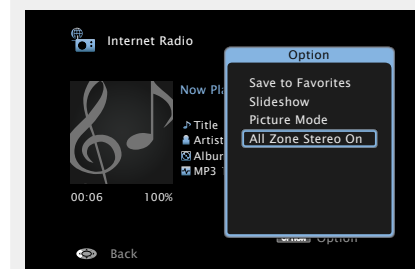

❑ Stopping the All Zone Stereo function (All Zone Stereo Off)

1 During playback in All Zone Stereo, press **OPTION**.
The option menu screen is displayed.

2 Use Δ / ∇ to select “All Zone Stereo Off”, then press **ENTER**.

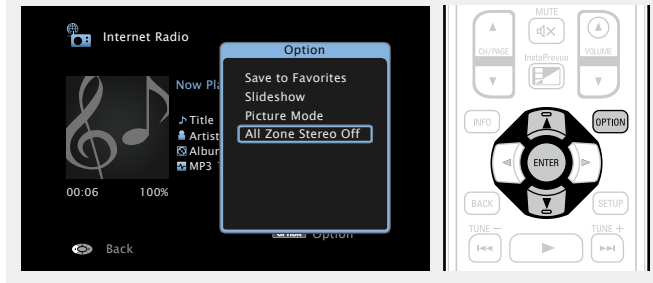

The All Zone Stereo function is also stopped when you:

- Turn MAIN ZONE off.
- Change the input source for MAIN ZONE.
- Change the sound mode.

NOTE

When “HDMI Audio Out” ([page 129](#)) is set to “TV”, the All Zone Stereo function is not available.

AirPlay function

Enjoy music from your iTunes library with high quality sound anywhere in your home.

Use the Apple Remote App* for iPhone, iPod touch and iPad to control iTunes from any room in your home.

* Available as a free download from the App Store.

Streaming music stored in iPhone, iPod touch, or iPad directly to the unit

If you update your "iPhone/iPod touch/iPad" to iOS 4.2.1 or later, you can stream music stored in your "iPhone/iPod touch/iPad" directly to this unit.

1 Make the Wi-Fi settings for iPhone, iPod touch, or iPad.

• For details, see your device's manual.

2 Startup iPhone, iPod touch, or iPad music or iPod app.

 is displayed on the iPhone, iPod touch or iPad screen.

3 Tap the AirPlay icon .

4 Select the speaker you want to use.

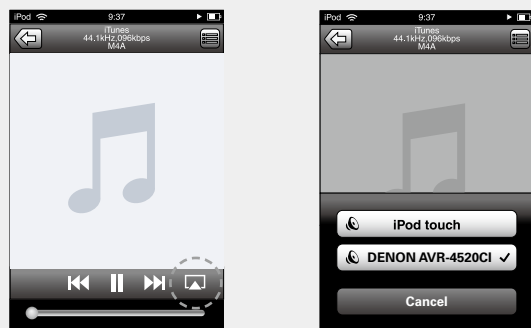

NOTE

In playback using the AirPlay function, the sound is output at the iPhone, iPod touch, iPad or iTunes volume setting level.

You should turn down the iPhone, iPod touch, iPad or iTunes volume prior to playback and then adjust it to a suitable level.

Playing iTunes music with this unit

1 Install iTunes 10, or later, on a Mac or Windows PC that is connected to the same network as this unit.

2 Turn this unit ON.

Set "Network" ([see page 147](#)) to "Always On" for this unit.

NOTE

When "Network" is set to "Always On", the unit consumes more standby power.

3 Launch iTunes and click the AirPlay icon displayed in the lower right of the window and select this unit from the list.

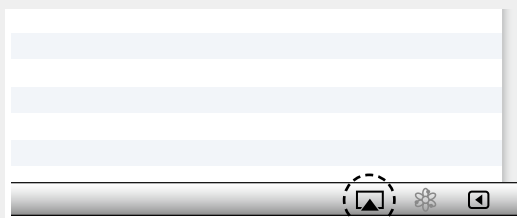

4 Choose a song and click play in iTunes.

The music will stream to this unit.

Selecting multiple speakers (devices)

It is possible to play iTunes songs on your home's AirPlay compatible speakers (devices) other than those of this unit.

1 Click the AirPlay icon and select "Multiple Speakers" from the list.

2 Check the speakers you want to use.

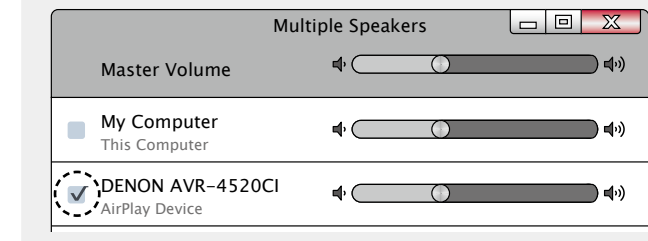

❑ Perform iTunes playback operations with the remote control unit of this unit

With this unit's remote control unit, you can perform iTunes song play, pause, and auto search (cue) operations.

1 Select "Edit" – "Preferences..." on the menu.

2 Select "Devices" in the iTunes setting window.

3 Check "Allow iTunes control from remote speakers", and then click "OK".

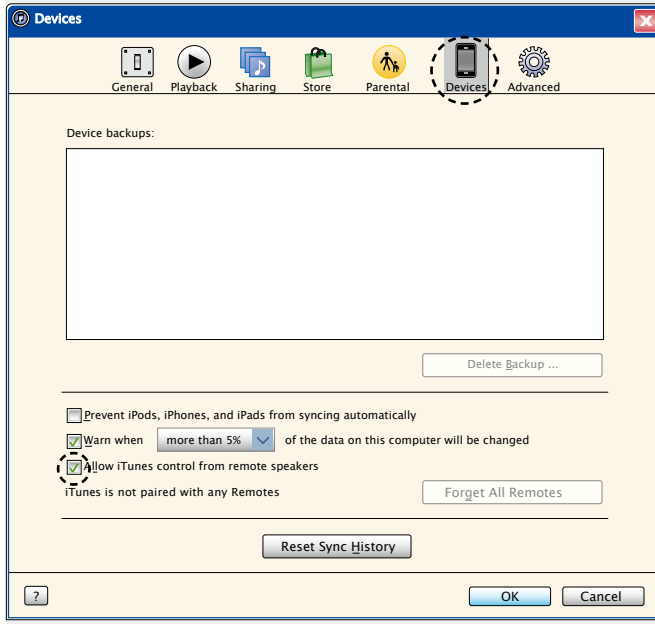

-  is displayed on the menu screen while AirPlay is being operated.
- Source input will be switched to "NETWORK" when AirPlay playback is started.
- You can stop AirPlay playback by pressing the ◀ or choosing other input source.
- To see song and artist names together, press **STATUS** on the main unit.
- For information about how to use iTunes, also see the Help for iTunes.
- The screen may differ depending on the OS and software versions.

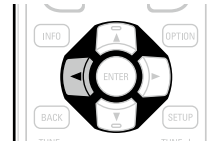

Selecting a listening mode (Sound Mode)

This unit allows you to enjoy various kinds of surround and stereo playbacks.

Multi-channel audio formats are adopted by many of the contents including Blu-ray disc and DVD as well as digital broadcasting and Internet-delivered movies and music.

This unit supports playback of almost all of these multi-channel audio formats. It also supports surround playback of audio formats other than multi-channel audio such as 2-channel stereo audio.

This unit automatically generates a list of all the playable sound modes based on the input audio format and the current speaker setup configuration and displays the list on the screen. Therefore, you can select a correct surround playback mode even if you are not familiar with sound mode selection. Try out various surround playback modes and enjoy surround playback in your favorite mode.

[Example] When **MOVIE** is pressed and held

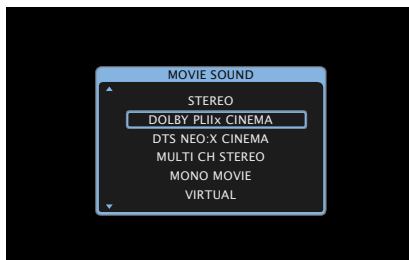

This unit provides not only sound modes that conform to the formats recorded in discs such as Dolby and DTS but also extended types of modes that match your speaker configuration including front height speakers and surround back speakers and "original listening modes" that create atmosphere of ROCK ARENA and JAZZ CLUB, etc. The displayed sound modes include the 2-channel stereo playback mode.



For audio formats recorded in a disc, see the disc jacket.

Selecting a listening mode

1 Play the selected device (🔗 [page 42 – 74](#)).

2 Press and hold **MOVIE**, **MUSIC** or **GAME** to select a listening mode.

This unit automatically generates and displays a list of selectable sound modes.

- Each time **MOVIE**, **MUSIC** or **GAME** is pressed, the listening mode is switched.

MOVIE Switches to the listening mode suitable for enjoying movies and TV programs.

MUSIC Switches to the listening mode suitable for enjoying music.

GAME Switches to the listening mode suitable for enjoying games.

- Pressing **MOVIE**, **MUSIC** or **GAME** displays a list of the listening modes that can be selected. Each time you press **MOVIE**, **MUSIC** or **GAME**, the listening mode changes.
- While the list is displayed, you can also use Δ / ∇ to select a listening mode.

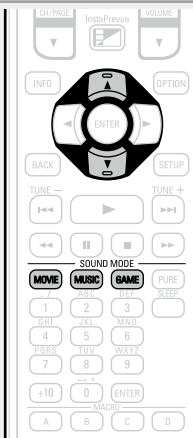

- The **MOVIE**, **MUSIC**, or **GAME** button memorizes the last sound mode selected for its button. Pressing **MOVIE**, **MUSIC**, or **GAME** recalls the same sound mode as the one selected at the previous playback.
- If the content played back does not support the previously selected sound mode, the most standard sound mode for the content is automatically selected.

Direct/DSD Direct playback

Sound recorded in source is played as is.

1 Play the selected device (🔗 [page 42 – 74](#)).

2 Press **PURE** to select "DIRECT" or "DSD DIRECT". Direct playback begins.



"DSD DIRECT" is shown on the display when playing DSD signals in the DIRECT mode.

Pure direct playback

This mode is for playback in higher sound quality than in "DIRECT" mode. Turn the display of the amplifier off to stop the analogue video circuit. This suppresses the source of noise that affects sound quality.

1 Play the selected device (🔗 [page 42 – 74](#)).

2 Press **PURE** to select "PURE DIRECT". The display goes dark, and pure direct playback begins.



In DIRECT/DSD DIRECT and PURE DIRECT listening mode, the following items cannot be adjusted.

- Tone (🔗 [page 123](#))
- Restorer (🔗 [page 124](#))
- MultEQ® XT 32 (🔗 [page 125](#))
- Dynamic EQ (🔗 [page 125](#))
- Dynamic Volume (🔗 [page 126](#))

NOTE

- Video signals are only output when HDMI signals are played in the PURE DIRECT mode.
- When in the PURE DIRECT mode, the menu screen is not displayed.
- When in the PURE DIRECT mode, the display turns off and appears as if there is no electricity.

Listening mode

- The following listening modes can be selected using the **MOVIE**, **MUSIC**, **GAME**, and **PURE** buttons.
- Adjust the sound field effect with the menu "Surround Parameter" (page 121) to enjoy your favorite sound mode.

Operation button	Input signal	Listening mode
MOVIE	2-channel *1	STEREO
		DOLBY PLIIx Cinema *2 / DOLBY PLIIx Cinema A-DSX *4
		DOLBY PLII Cinema *2 / DOLBY PLII Cinema A-DSX *4
		DOLBY PLIIz Height *2
		DTS NEO:X Cinema *2 *5
		MULTI CH STEREO
		WIDE SCREEN
		MONO MOVIE
		VIRTUAL
		Multi-channel *3
	Dolby Digital	DOLBY DIGITAL / DOLBY DIGITAL A-DSX *4
		DOLBY DIGITAL EX DOLBY DIGITAL + PLIIx Cinema
		DOLBY DIGITAL + PLIIz DOLBY DIGITAL + NEO:X Cinema
		DOLBY TrueHD / DOLBY TrueHD A-DSX *4
	Dolby TrueHD	DOLBY TrueHD + EX DOLBY TrueHD + PLIIx Cinema
		DOLBY TrueHD + PLIIz DOLBY TrueHD + NEO:X Cinema
		DOLBY DIGITAL Plus / DOLBY DIGITAL Plus A-DSX *4
		DOLBY DIGITAL Plus + EX DOLBY DIGITAL Plus + PLIIx Cinema
	Dolby Digital Plus	DOLBY DIGITAL Plus + PLIIz DOLBY DIGITAL Plus + NEO:X Cinema
		DTS SURROUND / DTS SURROUND A-DSX *4
		DTS ES DSCRT 6.1 DTS ES MTRX 6.1
	DTS	DTS 96/24 DTS + PLIIx Cinema
		DTS + PLIIz DTS + NEO:X Cinema

Operation button	Input signal	Listening mode	
MOVIE	DTS-HD / DTS Express	DTS-HD HI RES / DTS-HD HI RES A-DSX *4	
		DTS-HD MSTR / DTS-HD MSTR A-DSX *4	
		DTS Express / DTS Express A-DSX *4	
		DTS-HD + PLIIx Cinema DTS-HD + PLIIz DTS-HD + NEO:X Cinema	
		PCM/DSD multi-channel	MULTI CH IN / MULTI CH IN A-DSX *4
			MULTI CH IN 7.1 MULTI IN + Dolby EX MULTI IN + PLIIx Cinema
			MULTI IN + PLIIz MULTI IN + NEO:X Cinema*5
			Multi-channel *3
	WIDE SCREEN MONO MOVIE		
	VIRTUAL		

- *1 2-channel also includes analog input.
- *2 This mode plays back 2-channel source in 5.1, 7.1, 9.1 or 11.1-channel playback. It cannot be selected when headphones are used, or when only front speakers are used.
- *3 Some listening modes cannot be selected, depending on the audio format or number of channels of the input signal. For details, see "Types of input signals, and corresponding sound modes" (page 187).
- *4 These modes add a new channel to the 5.1 channel surround using Audyssey DSX® processing (page 126). When "Heights" is selected in "Audyssey DSX®" (page 126), a front height channel is added in playback. When "Wides" is selected, a front wide channel is added in playback. When "Wides/Heights" is selected, a front wide channel and a front height channel are added in playback.
- *5 This mode cannot be selected when DSD signals are input.

Operation button	Input signal	Listening mode	
MUSIC	2-channel *1	STEREO	
		DOLBY PLIIx Music *2 / DOLBY PLIIx Music A-DSX *4	
		DOLBY PLII Music *2 / DOLBY PLII Music A-DSX *4	
		DOLBY PLIIz Height *2	
		DTS NEO:X Music *2 *5	
		MULTI CH STEREO	
		SUPER STADIUM	
		ROCK ARENA	
		JAZZ CLUB	
		CLASSIC CONCERT	
		MATRIX	
		VIRTUAL	
		Multi-channel *3	STEREO
	Dolby Digital	DOLBY DIGITAL / DOLBY DIGITAL A-DSX *4	
		DOLBY DIGITAL EX DOLBY DIGITAL + PLIIx Music DOLBY DIGITAL + PLIIz DOLBY DIGITAL + NEO:X Music	
		Dolby TrueHD	DOLBY TrueHD / DOLBY TrueHD A-DSX *4
			DOLBY TrueHD + EX DOLBY TrueHD + PLIIx Music DOLBY TrueHD + PLIIz DOLBY TrueHD + NEO:X Music
	Dolby Digital Plus		DOLBY DIGITAL Plus / DOLBY DIGITAL Plus A-DSX *4
		DOLBY DIGITAL Plus + EX DOLBY DIGITAL Plus + PLIIx Music DOLBY DIGITAL Plus + PLIIz DOLBY DIGITAL Plus + NEO:X Music	
		DTS	DTS SURROUND / DTS SURROUND A-DSX *4
			DTS ES DSCRT 6.1
	DTS ES MTRX 6.1		
	DTS 96/24		
	DTS + PLIIx Music		
	DTS + PLIIz		
	DTS + NEO:X Music		

Operation button	Input signal	Listening mode	
MUSIC	DTS-HD / DTS Express	DTS-HD HI RES / DTS-HD HI RES A-DSX *4	
		DTS-HD MSTR / DTS-HD MSTR A-DSX *4	
		DTS Express / DTS Express A-DSX *4	
		DTS-HD + PLIIx Music	
		DTS-HD + PLIIz	
		DTS-HD + NEO:X Music	
		PCM/DSD multi-channel	MULTI CH IN / MULTI CH IN A-DSX *4
			MULTI CH IN 7.1
	MULTI IN + Dolby EX MULTI IN + PLIIx Music		
	MULTI IN + PLIIz MULTI IN + NEO:X Music *5		
	Multi-channel *3	MULTI CH STEREO	
		SUPER STADIUM	
		ROCK ARENA	
		JAZZ CLUB	
		CLASSIC CONCERT	
		MATRIX VIRTUAL	

- *1 2-channel also includes analog input.
- *2 This mode plays back 2-channel source in 5.1, 7.1, 9.1 or 11.1-channel playback. It cannot be selected when headphones are used, or when only front speakers are used.
- *3 Some listening modes cannot be selected, depending on the audio format or number of channels of the input signal. For details, see "Types of input signals, and corresponding sound modes" (page 187).
- *4 These modes add a new channel to the 5.1 channel surround using Audyssey DSX® processing (page 126). When "Heights" is selected in "Audyssey DSX®" (page 126), a front height channel is added in playback. When "Wides" is selected, a front wide channel is added in playback. When "Wides/Heights" is selected, a front wide channel and a front height channel are added in playback.
- *5 This mode cannot be selected when DSD signals are input.

Operation button	Input signal	Listening mode
GAME	2-channel *1	STEREO
		DOLBY PLIIx Game *2 / DOLBY PLIIx Game A-DSX *4
		DOLBY PLII Game *2 / DOLBY PLII Game A-DSX *4
		DOLBY PLIIz Height *2
		DTS NEO:X Game *2 *5
		MULTI CH STEREO
		VIDEO GAME
		VIRTUAL
	Multi-channel *3	STEREO
	Dolby Digital	DOLBY DIGITAL / DOLBY DIGITAL A-DSX *4
		DOLBY DIGITAL EX
		DOLBY DIGITAL + PLIIz
		DOLBY DIGITAL + NEO:X
	Dolby TrueHD	DOLBY TrueHD / DOLBY TrueHD A-DSX *4
		DOLBY TrueHD + EX
		DOLBY TrueHD + PLIIz
		DOLBY TrueHD + NEO:X Game
	Dolby Digital Plus	DOLBY DIGITAL Plus / DOLBY DIGITAL Plus A-DSX *4
		DOLBY DIGITAL Plus + EX
		DOLBY DIGITAL Plus + PLIIz
		DOLBY DIGITAL Plus + NEO:X Game
	DTS	DTS SURROUND / DTS SURROUND A-DSX *4
		DTS ES DSCRT 6.1
		DTS ES MTRX 6.1
		DTS 96/24
		DTS + PLIIz
		DTS + NEO:X Game
DTS-HD / DTS Express	DTS-HD HI RES / DTS-HD HI RES A-DSX *4	
	DTS-HD MSTR / DTS-HD MSTR A-DSX *4	
	DTS Express / DTS Express A-DSX *4	
	DTS-HD + PLIIz	
	DTS-HD + NEO:X Game	

Operation button	Input signal	Listening mode
GAME	PCM/DSD multi-channel	MULTI CH IN / MULTI CH IN A-DSX *4
		MULTI CH IN 7.1
		MULTI IN + Dolby EX
		MULTI IN + PLIIz
		MULTI IN + NEO:X Game *5
PURE	Multi-channel *3	MULTI CH STEREO VIDEO GAME VIRTUAL
	All	PURE DIRECT
	Except DSD	DIRECT
	DSD	DSD DIRECT

- *1 2-channel also includes analog input.
- *2 This mode plays back 2-channel source in 5.1, 7.1, 9.1 or 11.1-channel playback. It cannot be selected when headphones are used, or when only front speakers are used.
- *3 Some listening modes cannot be selected, depending on the audio format or number of channels of the input signal. For details, see "Types of input signals, and corresponding sound modes" (page 187).
- *4 These modes add a new channel to the 5.1 channel surround using Audyssey DSX® processing (page 126). When "Heights" is selected in "Audyssey DSX®" (page 126), a front height channel is added in playback. When "Wides" is selected, a front wide channel is added in playback. When "Wides/Heights" is selected, a front wide channel and a front height channel are added in playback.
- *5 This mode cannot be selected when DSD signals are input.

Views on the TV screen or display

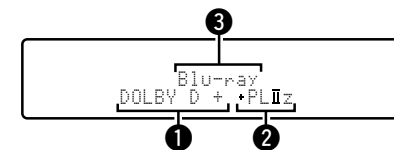

- 1 Shows a decoder to be used.
 - A DOLBY DIGITAL Plus decoder is displayed as "DOLBY D +".
- 2 Shows a decoder that creates sound output from the surround back speakers.
 - "+ PLIIz" indicates the front height sound from front height speakers.
- 3 Shows the name of the input source being played back.

□ Description of listening mode types

Dolby listening mode

Listening mode type	Description
DOLBY PLIIx*1	This mode can be selected when a Dolby Pro Logic IIx decoder is used to play back 2-channel source in 6.1/7.1-channel surround sound including the surround back channel. By adding the surround back channel, a stronger surround feeling is obtained compared to Dolby Pro Logic II. There are three playback modes: "Cinema" mode that is optimized for movie playback, "Music" mode that is optimized for music playback, and "Game" mode that is optimized for game play.
DOLBY PLII	This mode can be selected when a Dolby Pro Logic II decoder is used to play back 2-channel source in 5.1-channel surround sound with a natural, realistic feel.
DOLBY PLIIz*2	This mode can be selected when a Dolby Pro Logic IIz decoder is used to play back 2-channel source in 7.1-channel surround sound with added front height channel. By adding a front height channel, the vertical expression is emphasized, improving the three-dimensionality of the sound.
DOLBY DIGITAL	This mode can be selected when playing sources recorded with Dolby Digital.
DOLBY DIGITAL EX*1	Using a Dolby Digital EX decoder, this mode plays Dolby Digital source in 6.1/7.1 channel surround sound with added surround back channel. By adding a surround back channel, spacial expressiveness and sound localization are enhanced.
DOLBY TrueHD	This mode can be selected when playing sources recorded in Dolby TrueHD.
DOLBY DIGITAL Plus	This mode can be selected when playing sources recorded with Dolby Digital Plus.

*1 This can be selected when "Speaker Config." – "Surr. Back" ([page 142](#)) is not set to "None".

*2 This can be selected when "Speaker Config." – "Front Height" ([page 142](#)) is not set to "None".

DTS listening mode

Listening mode type	Description
DTS NEO:X*1	This matrix decoding technology uses the DTS NEO:X decoder to playback 2-channel source or 5.1/6.1/7.1 channel surround sources as a maximum of 11.1 channel surround sound. There are 3 modes: "Music" suited for playing music, "Cinema" suited for playing movies, and "Game" which is optimized for playing games.
DTS SURROUND	This mode can be selected when playing sources recorded in DTS.
DTS ES DSCRT6.1*2	This mode is suitable for playing discs recorded in DTS-ES. The surround back channel added using the discrete method is played as an independent channel. Since all channels are independent, the 360-degree spacial expressiveness and sound localization are enhanced.
DTS ES MTRX6.1*3	This mode is suitable for playing discs recorded in DTS-ES. The surround back channel added to the surround-left and surround-right channels by a matrix encoder at software recording time is decoded by this unit's matrix decoder and played from each channel (surround left, surround right, surround back).
DTS 96/24	This mode can be selected when playing sources recorded in DTS 96/24.
DTS-HD	This mode can be selected when playing sources recorded in DTS-HD.
DTS Express	This mode can be selected when playing sources recorded in DTS Express.

*1 This mode cannot be selected when DSD signals are input.

*2 This mode can be selected when only one surround back speaker is used and no front height speaker or front wide speaker is used.

*3 This can be selected when "Speaker Config." – "Surr. Back" ([page 142](#)) is not set to "None".

PCM/DSD multi-channel listening mode

Listening mode type	Description
MULTI CH IN	This mode can be selected when playing multi-channel PCM/DSD sources .

Audyssey DSX® listening mode

Listening mode type	Description
Audyssey DSX® (A-DSX)*	This mode creates playback for the new channels (front wide or front height) in 5.1-channel systems. By adding front wide or front high channels, the surround sound effects sound more three dimensional and realistic.

* This mode is displayed when “Audyssey DSX®” (page 126) is set to “Wides/Heights”, “Heights” or “Wides”.

Original listening mode

Listening mode type	Description
MULTI CH STEREO	This mode is for enjoying stereo sound from all speakers. The same sound as that from the front speakers (L/R) is played back at the same level from the surround speakers (L/R) and surround back speakers (L/R).
WIDE SCREEN	This mode is for enjoying the atmosphere of viewing a movie on a large screen.
SUPER STADIUM	This mode is suited for viewing sports programs.
ROCK ARENA	This mode is for enjoying the atmosphere of a live concert in an arena.
JAZZ CLUB	This mode is for enjoying the atmosphere of a live concert in a jazz club.
CLASSIC CONCERT	This mode is for appreciating classical concert programs.
MONO MOVIE	This mode is for playing monaural movie sources with surround sound. When playing sources recorded in monaural in the “MONO MOVIE” mode, the sound will be off balance with a single channel (left or right), so input to both channels.
VIDEO GAME	This mode is suited for achieving surround sound with video games.
MATRIX	This mode lets you add a spacious feel to stereo music sources.
VIRTUAL	This mode is for enjoying surround effects using only the front speakers or headphones.

STEREO listening mode





Listening mode type	Description
STEREO	This is the mode for playing in stereo. The tone can be adjusted. <ul style="list-style-type: none"> • Sound is output from the front left and right speakers and subwoofer. • If multichannel signals are input, they are mixed down to 2-channel audio and are played.

Direct listening mode

Listening mode type	Description
DIRECT/DSD DIRECT	Sound recorded in source is played as is.
PURE DIRECT	This mode is for playback in higher sound quality than in DIRECT mode. This suppresses the source of noise that affects sound quality. The following circuits that affect sound quality are set to off. <ul style="list-style-type: none"> • Main unit’s display circuit (The display is turned off.) • Analog video input/output circuit

Advanced version

Here, we explain functions and operations that let you make better use of this unit.

- **Installation/connection/setup of speakers (Advanced)**  [page 91](#)
- **Playback (Advanced operation)**  [page 102](#)
- **Playback in ZONE2/ZONE3/ZONE4 (Separate room)**  [page 111](#)
- **How to make detailed settings**  [page 114](#)
- **Operating external devices with the remote control**  [page 157](#)

Installation/connection/setup of speakers (Advanced)

Procedure for speaker settings

Speaker installation



Speaker connection (👉 [page 93](#))



Set up speakers (👉 [page 99](#))

Speaker installation

- Determine the speaker system depending on the number of speakers you are using and install each speaker and subwoofer in the room. Here, we explain how to install the speakers using a typical example.
- The speaker impedance should be from 6 to 16 Ω .

This unit is compatible with Audyssey DSX[®] (👉 [page 193](#)), Dolby Pro Logic IIz (👉 [page 194](#)) and DTS Neo:X (👉 [page 194](#)) which offers an even wider and deeper surround sensation. When using Audyssey DSX[®], install front wide speakers or front height speakers. When using Dolby Pro Logic IIz, install front height speakers.



Use the illustration below as a guide for how high each speaker should be installed. The height does not need to be exactly the same.

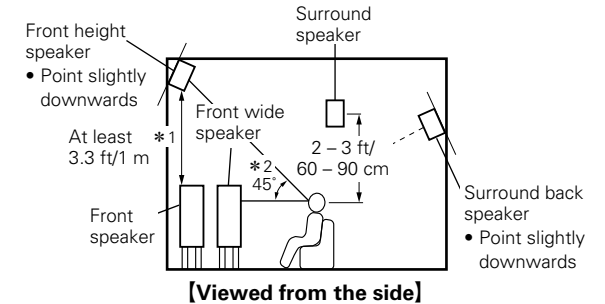

- *1 Recommended for Dolby Pro Logic IIz
- *2 Recommended for Audyssey DSX[®]

NOTE

Depending on the "Amp Assign" (👉 [page 141](#)) setting, audio cannot be output simultaneously from the surround back, front height, and front wide speakers.

Typical speaker layout

When using Audyssey DSX[®], install front wide speakers or front height speakers.

When using Dolby Pro Logic IIz, install front height speakers.

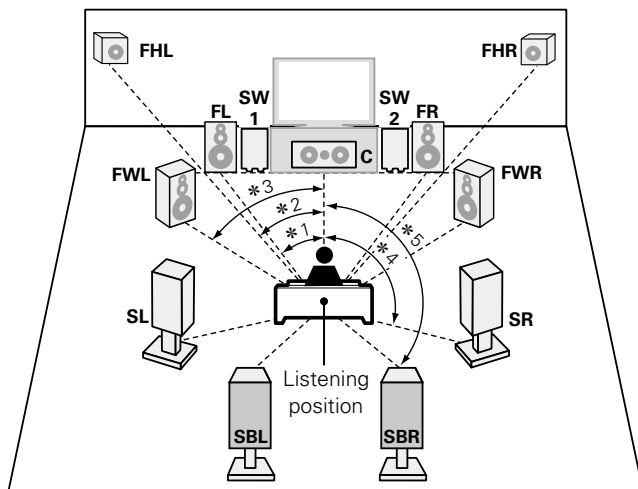

- *1 22° - 30° *2 22° - 45° *3 55° - 60°
- *4 90° - 110° *5 135° - 150°

[Speaker abbreviations]

- FL** Front speaker (L)
- FR** Front speaker (R)
- C** Center speaker
- SW** Subwoofer
- SL** Surround speaker (L)
- SR** Surround speaker (R)
- SB** Surround back speaker
- SBL** Surround back speaker (L)
- SBR** Surround back speaker (R)
- FHL** Front height speaker (L)
- FHR** Front height speaker (R)
- FWL** Front wide speaker (L)
- FWR** Front wide speaker (R)

When 6.1ch speakers are installed

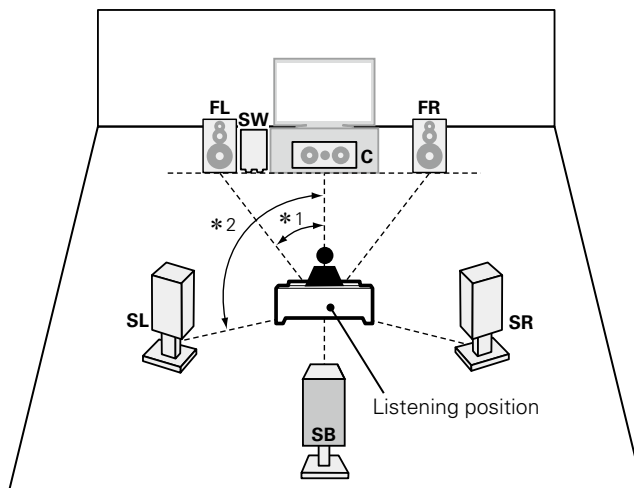

- *1 22° - 30° *2 90° - 110°

When 5.1ch speakers are installed

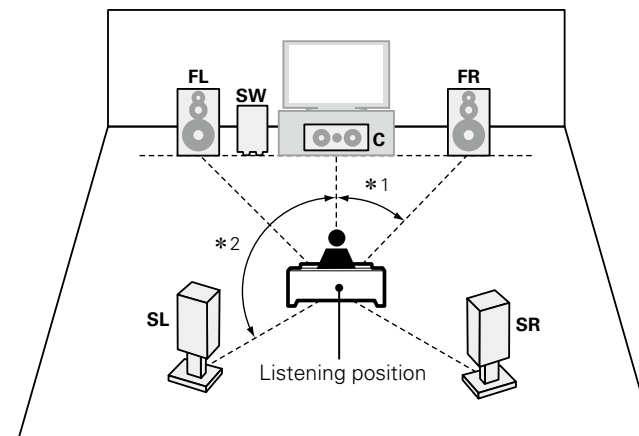

- *1 22° - 30° *2 120°

Speaker connection

Here, we connect the speakers in the room to this unit.
This section explains how to connect them using a typical example.

- ❑ Normal connection ([page 94](#))
- ❑ Bi-amp connection ([page 95](#))
- ❑ Multi-channel + 2-channel connection ([page 96](#))
- ❑ 11.1-channel connection ([page 97](#))
- ❑ External power amplifier connection ([page 98](#))

NOTE

- Disconnect this unit's power plug from the power outlet before connecting the speakers. Also, turn off the subwoofer.
- Connect so that the speaker cable core wires do not protrude from the speaker terminal. The protection circuit may be activated if the core wires touch the rear panel or if the + and - sides touch each other ([page 195](#) "Protection Circuit").
- Never touch the speaker terminals while the power supply is connected. Doing so could result in electric shock. When the "Setup Assistant" is running, follow the instructions in the "Setup Assistant" screen for making connections. (Power is not supplied to the speaker terminals while the "Setup Assistant" is running.)
- Use speakers with the speaker impedances shown below.

Speaker terminals	Speaker impedance
FRONT	4 – 16 Ω
CENTER	
SURROUND	
SURROUND BACK	
FRONT HEIGHT	
FRONT WIDE	



- Use speakers where one speaker has an impedance of 4 to 16 Ω. When using a speaker with impedance of 4 Ω or 6 Ω, make sure to set the "Impedance" in the menu ([page 145](#)) to "6 Ω/ohms" or "4 Ω/ohms".
- On this unit, you can change how the power amplifiers within this unit are used according to your environment. For details see "Relationship between the Amp Assign mode settings and audio output" ([page 177](#)).

Connecting the speaker cables

Carefully check the left (L) and right (R) channels and + (red) and - (black) polarities on the speakers being connected to this unit, and be sure to interconnect the channels and polarities correctly.

1 Peel off about 0.03 ft/10 mm of sheathing from the tip of the speaker cable, then either twist the core wire tightly or terminate it.



2 Turn the speaker terminal counterclockwise to loosen it.

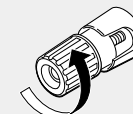

3 Insert the speaker cable's core wire to the hilt into the speaker terminal.

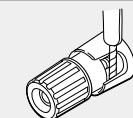

4 Turn the speaker terminal clockwise to tighten it.

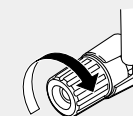

Cables used for connections

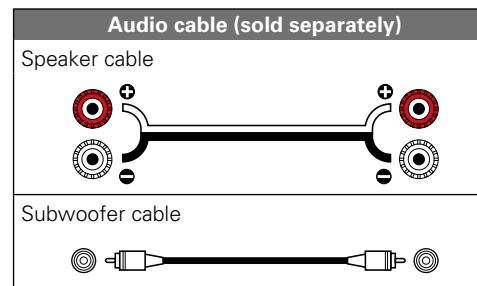

Connecting the subwoofer

Use a subwoofer cable to connect the subwoofer.

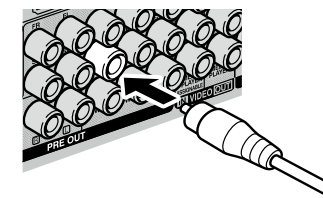

Normal connection

The diagram on the right shows a typical connection method. Connect your speakers so that they correspond to the speaker names indicated on the rear panel.

- If you connect the surround back, front height, and front wide speakers before you start playback, the audio is played back by automatically switching the speakers in accordance with the surround mode or input signals.
 - If using only one surround back speaker, connect to the “L” side of the SURROUND BACK terminal. Also use the “Speaker Config.” setting ([page 142](#)) to set “Surr. Back” to “1spkr”.
- For speaker settings in this case, see “When 6.1ch speakers are installed” ([page 92](#)).

NOTE

- For speaker cable connections, see [page 93](#).
- For speaker impedance, see [page 93](#).

For connecting two subwoofers

Two subwoofers can be connected to this unit.

To use two subwoofers, set “Subwoofer” to “2 spkr” using the “Speaker Config.” setting ([page 142](#)).

The level and distance can be set separately for Subwoofer 1 and Subwoofer 2.

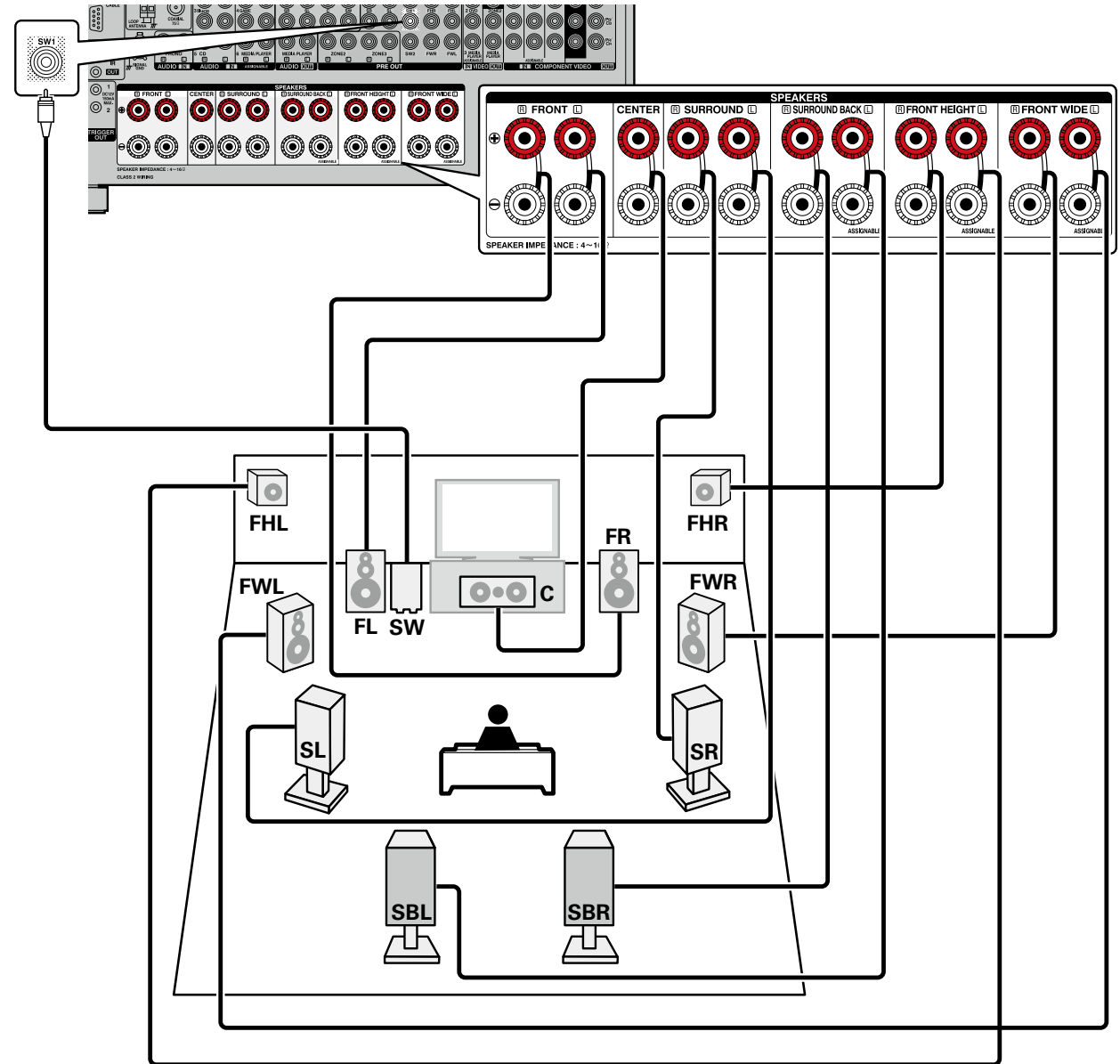
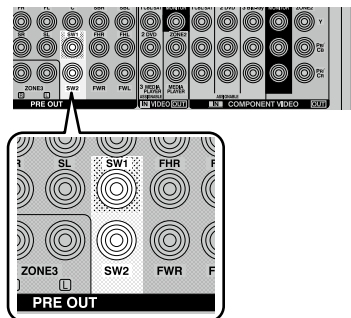

Bi-amp connection

A bi-amp connection is to connect separate amplifiers to the tweeter terminals and woofer terminals of speakers compatible with the bi-amp function. This prevents the back electromotive force (returned force without output) of the woofer sent to the tweeter, which affects the sound quality of the tweeter, and you can enjoy playback with higher-quality sound.

In this case, set "Assign Mode" to "7.1ch(Bi-Amp)" or "5.1ch(Bi-Amp) + ZONE2" in steps 3 to 5 for "Set up "Amp Assign"" (☞ [page 99](#)).

NOTE

- For speaker cable connections, see [page 93](#).
- For speaker impedance, see [page 93](#).
- When making bi-amp connections, be sure to remove the short-circuiting plate or wire between the speaker's woofer and tweeter terminals.

When using a front wide speaker, you can use the connectors on the part in the connection diagram to make a bi-amplifier connection. To make connections for these connectors, set "Main Speakers" (☞ [page 100](#)).

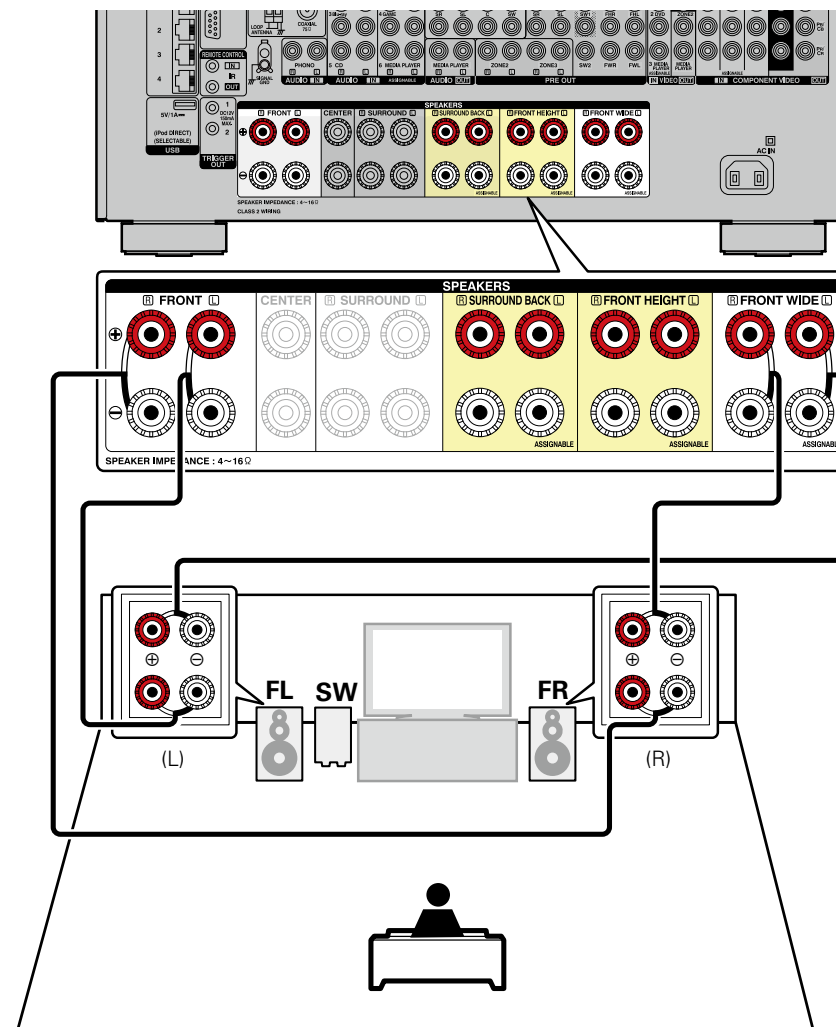

Multi-channel + 2-channel connection

You can connect the other front speakers for 2-channel playback using the DIRECT mode or STEREO mode.

The speakers used exclusively for multichannel playback and the speakers used exclusively for 2-channel playback are automatically switched for playback in accordance with the surround mode.

In this case, set "Assign Mode" to "9.1ch/2ch Front" in steps 3 to 5 for "Set up "Amp Assign"" ([page 99](#)).



Front speakers can be used separately, depending on the speaker's specifications or playback source such as front speakers (FL/FR) for multichannel playback and front speakers (FL'/FR') for 2-channel playback ([page 145](#) "Front Speaker").

NOTE

- For speaker cable connections, see [page 93](#).
- For speaker impedance, see [page 93](#).

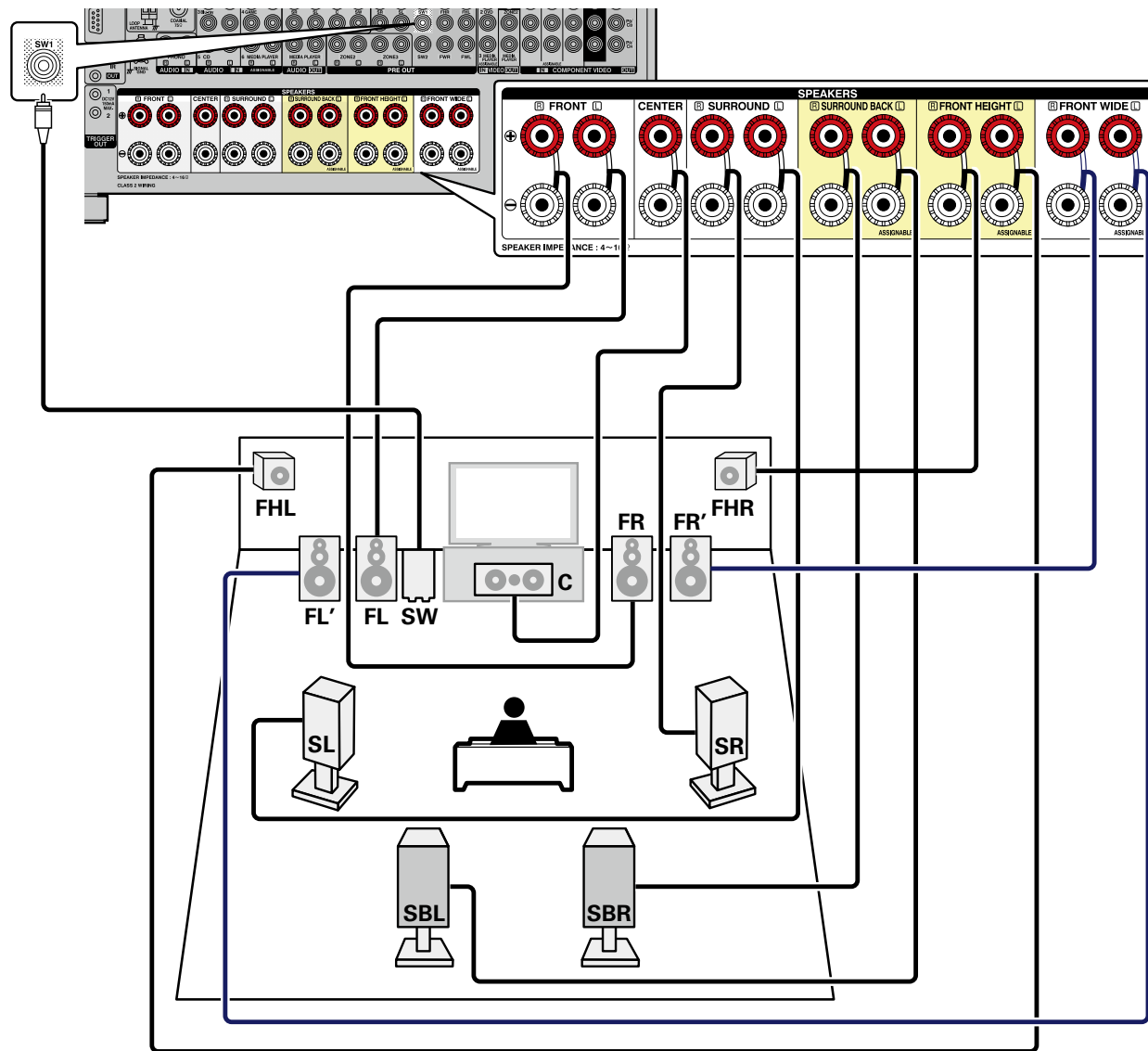
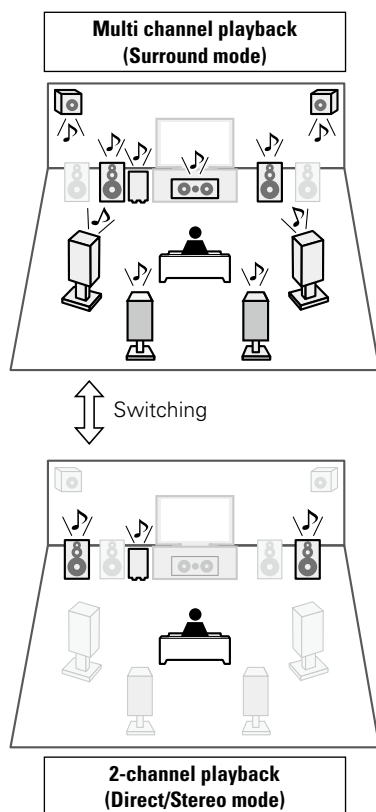

When using a front wide speaker, you can connect a second front speaker to the part in the connection diagram. To make connections for these connectors, set "Main Speakers" ([page 100](#)).

11.1-channel connection

You can perform playback using up to 11.1 channels using a combination of the built-in power amplifier for 9-channel and an external power amplifier for 2-channel. Connect the external amplifier to the PRE OUT connector.

- To perform 11.1-channel playback, select “Amp Assign” and set “Assign Mode” to “Discrete 11.1ch” using steps 3 and 5 of “Set up “Amp Assign”” ([page 99](#)).
- You can also follow step 7 in “Set up “Amp Assign”” ([page 99](#)) to change the PRE OUT connector connected to the power amplifier to the front channel.

NOTE

- For speaker cable connections, see [page 93](#).
- For speaker impedance, see [page 93](#).

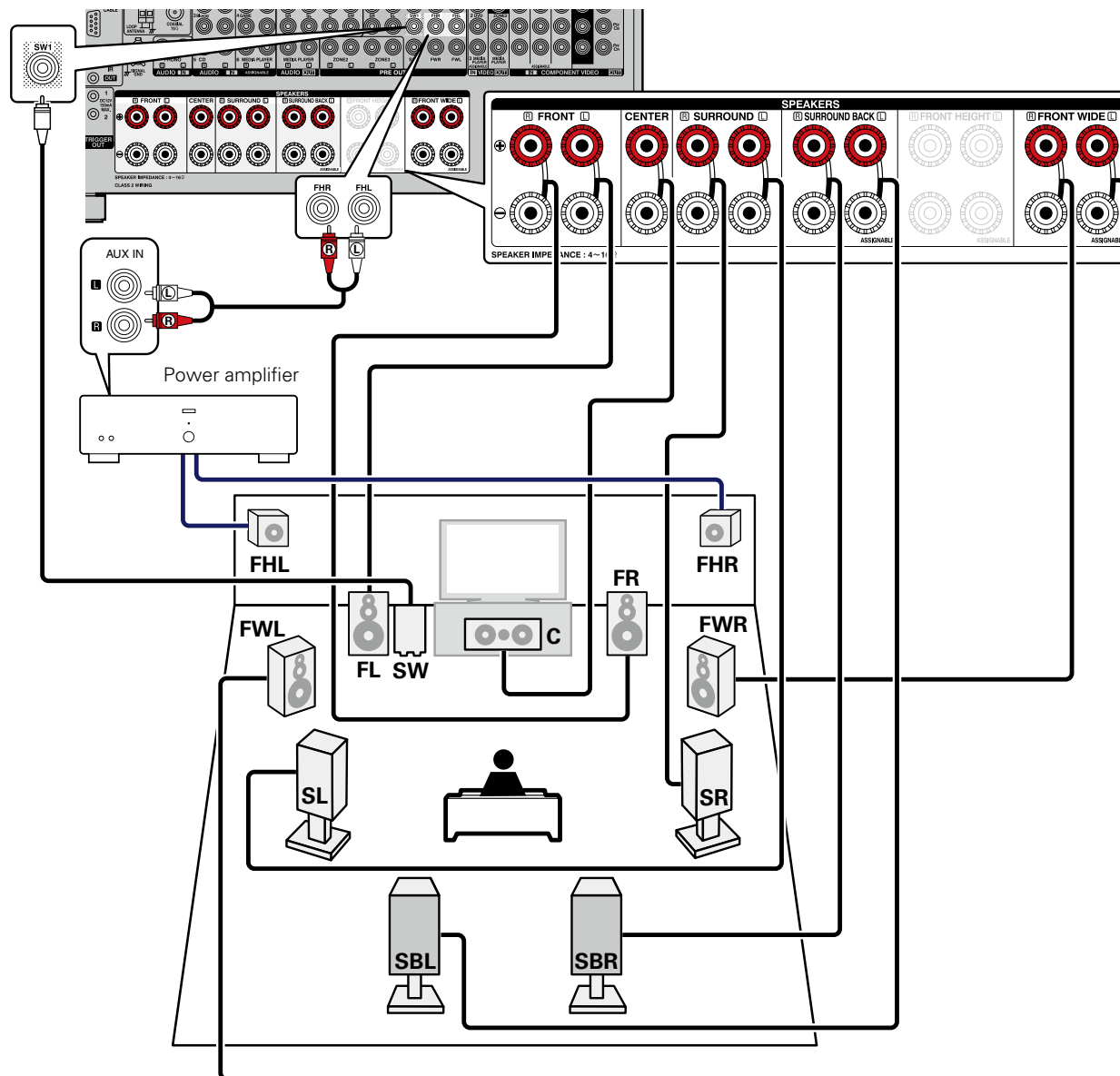

External power amplifier connection

You can connect all speakers to an external power amplifier and use this unit as a preamplifier.

Using this unit as a preamplifier, you can perform up to 11.1-channel playback.

When the preamplifier mode is used, the built-in power amplifier operation of this unit is stopped, and interference to the preamplifier from the power amplifier can be reduced.

To use this unit as a preamplifier, select "Amp Assign" and set "Assign Mode" to "Pre Amplifier" using steps 3 and 5 of "Set up "Amp Assign"" ([page 99](#)).



For connecting power amplifier and speaker systems, refer to the instruction manual supplied with the power amplifier to be used.

NOTE

- For speaker cable connections, see [page 93](#).
- For speaker impedance, see [page 93](#).

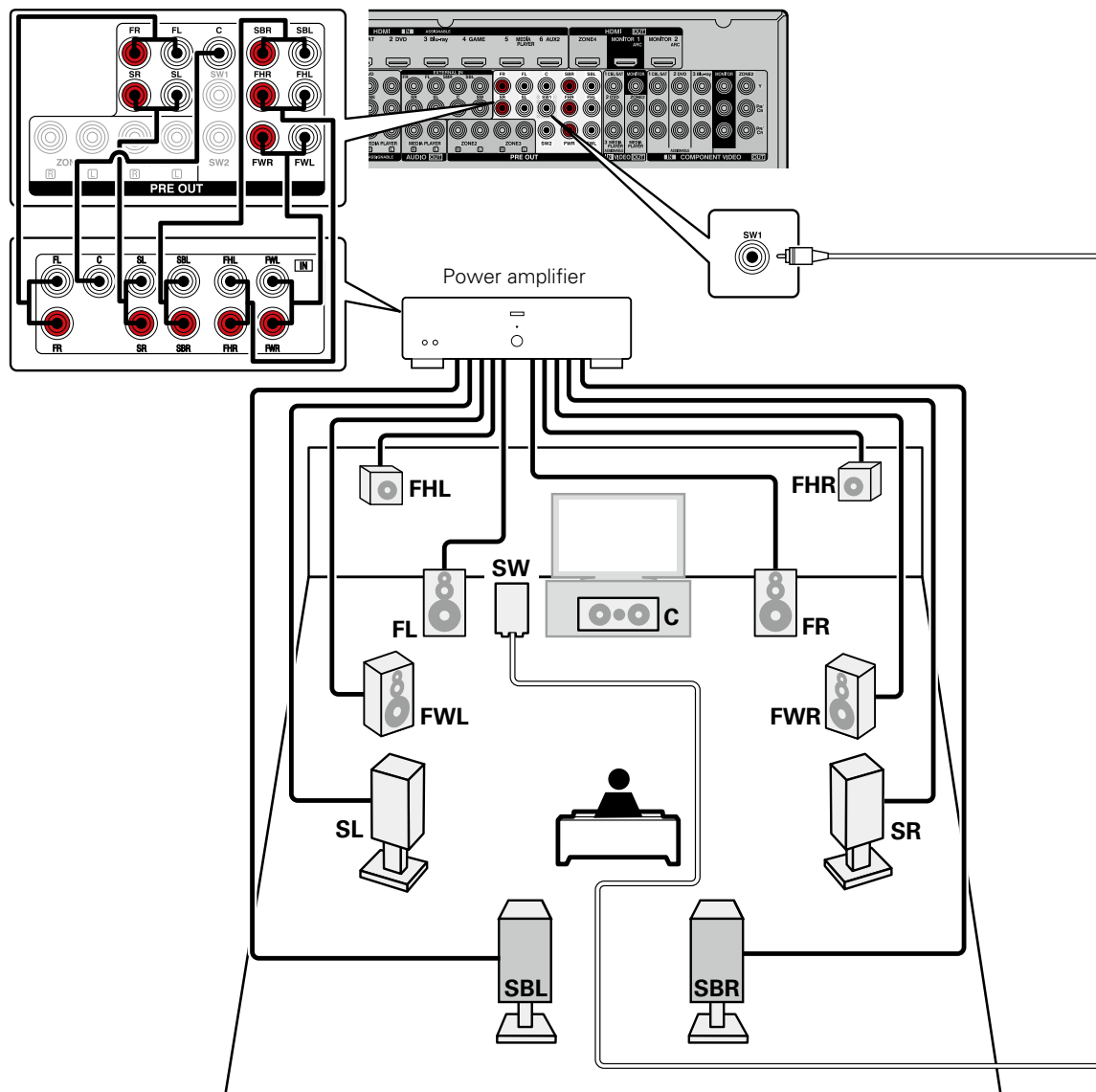

Set up speakers

 around items indicate the settings.

This section describes detailed settings for Audyssey® Setup.

First install and connect the speakers to this unit.

Before Audyssey® Setup measurement, the settings shown below can be made.

- Changing the amplifier assignment (Amp Assign)
The signal output from the SURROUND BACK, FRONT HEIGHT and FRONT WIDE speaker terminal of this unit can be switched to match your speaker environment ([page 99](#) "Set up "Amp Assign"").
- Setting the channels to be used (Channel Select)
If channels that are not to be used are set in advance, measurement for the set channels is skipped, and measuring time can be reduced. You can also change the number of surround back speakers ([page 101](#) "Set up "Channel Select"").

1 Set up the zone mode

Press **ZONE SELECT** to switch the zone mode.
The **M** indicator lights.

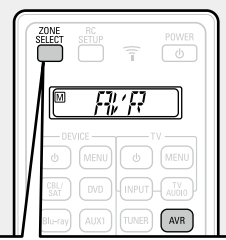

Press ZONE SELECT

NOTE
When using a remote control with preset codes registered ([page 160](#)), press **AVR** to set the remote control to the AVR-operation mode before operation.

2 Connect the setup microphone.

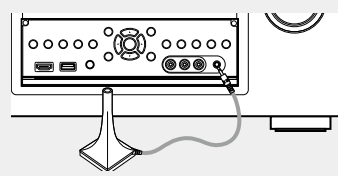

When the setup microphone is connected, the following screen is displayed.

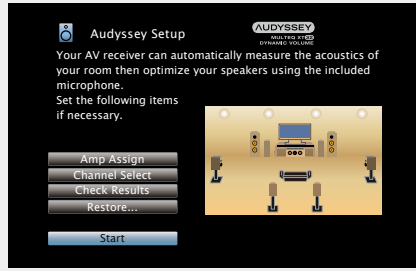

3 Set up "Amp Assign"

Use Δ / ∇ to select "Amp Assign", and then press **ENTER**.

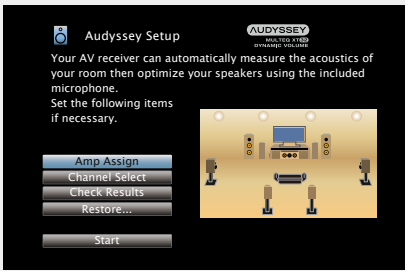

Amp Assign

Front	Speaker
Center	Speaker
Surround	Speaker
Surr. Back	Auto Spkr
Front Height	Auto Spkr
Front Wide	Not Used
ZONE2	Speaker
ZONE3	Pre-amp out

Assign Mode: 7.1 ch + ZONE2
S.Back/F.Height

Selects how to use the internal amplifiers

4 Select "Assign Mode", and then press **ENTER**.

5 Use ◀▶ to select the configuration of the connected speakers, and then press ENTER.



9.1ch (SB/FH/FW)	Assigns all power amplifiers within this unit for MAIN ZONE. Up to 9.1ch playback is available. In this case, go to step 6.
7.1ch + ZONE2	Assigns power amplifiers within this unit as follows: 7.1ch for MAIN ZONE and 2ch for ZONE2. In this case, go to step 6.
5.1ch + ZONE2/3	Assigns power amplifiers within this unit as follows: 5.1ch for MAIN ZONE and 2ch for ZONE2 and ZONE3 each. In this case, go to step 11.
7.1ch + ZONE2/3-MONO	Assigns power amplifiers within this unit as follows: 7.1ch for MAIN ZONE and 1ch for ZONE2 and ZONE3 each. In this case, go to step 6.
7.1ch(Bi-Amp)	Assigns power amplifiers within this unit as follows: 7.1ch for MAIN ZONE and 2ch for the front speaker bi-amplifier connection. In this case, go to step 6.
5.1ch(Bi-Amp) + ZONE2	Assigns power amplifiers within this unit as follows: 5.1ch for MAIN ZONE, 2ch for the front speaker bi-amplifier connection, and 2ch for ZONE2. In this case, go to step 11.
9.1ch/2ch Front	Assigns all power amplifiers within this unit for MAIN ZONE. Up to 9.1ch playback is available. You can also use a front speaker that is different from the one used during multi-channel playback for playback by switching the internal power amplifier during 2ch playback. In this case, go to step 6.
7.1ch/2ch Front(Bi-Amp)	Assigns power amplifiers within this unit as follows: 7.1ch for the MAIN ZONE multi-channel playback. You can also use a front speaker that is different from the one used during multi-channel playback for playback under the bi-amplifier connection by switching the internal power amplifier during 2ch playback. In this case, go to step 11.

7.1ch + Front B Assigns power amplifiers within this unit as follows: 7.1ch for MAIN ZONE and 2ch for the second front speaker connection. In this case, go to step 6.

Discrete 11.1ch Assigns 9.1ch for power amplifiers within this unit and 2ch (front/front height) for the external power amplifier connection. Up to 11.1ch playback is available. In this case, go to step 7.

Pre Amplifier Connects all speakers by using an external power amplifier and uses this unit as a preamplifier. In this case, go to step 8.

Custom Assigns power amplifiers within this unit as you prefer. In this case, go to step 10.

6 Use △▽ to select “Main Speakers” and use ◀▶ to select the speakers that output audio in MAIN ZONE.

S.Back/F.Height Outputs audio from the surround back and front height speakers.

S.Back/F.Wide Outputs audio from the surround back and front wide speakers.

F.Height/F.Wide Outputs audio from the front height and front wide speakers. When the setting is completed, go to step 11.

7 Use △▽ to select “Main Pre-amps” and use ◀▶ to select the PRE OUT connectors that connect the external power amplifier.

Front Connects the front channel PRE OUT connectors to the external power amplifier.

Front Height Connects the front height channel PRE OUT connectors to the external power amplifier. When the setting is completed, go to step 11.

8 Use △▽ to select “Pre-amp Assign” and use ◀▶ to select how to use the PRE OUT connectors.

All Select this to use the PRE OUT connectors without using power amplifiers within this unit and use this unit as a preamplifier.

Custom Sets whether to use each channel as a preamplifier or use speakers. When the setting is completed, go to step 9.

9 Use △▽ to select a channel to set and use ◀▶ to make the setting.

Speaker Select this to use speakers.

Pre-amp out Select this to output audio only from the PRE OUT connectors. When the setting is completed, go to step 11.

10 Use △▽ to select a speaker and use ◀▶ to set audio output from each speaker connector as you prefer.

• For details, see “Assign Mode” ([page 141](#)).

11 Press ENTER.

12 Press ◀ or BACK to exit the “Amp Assign” setting.

13 Set up "Channel Select"

Use $\Delta \nabla$ to select "Channel Select", and then press ENTER.

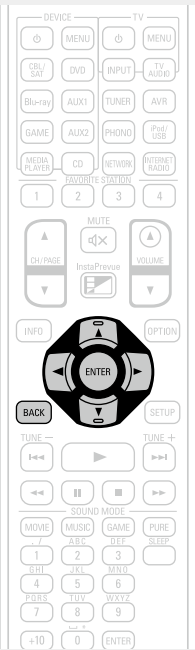
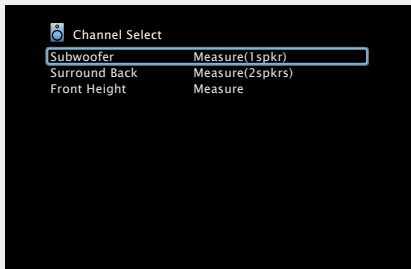
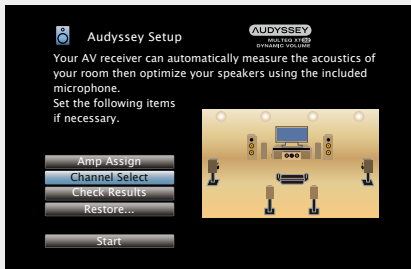

14 Use $\Delta \nabla$ to select a channel, and then press ENTER.

Front / Subwoofer / Surround Back / Front Height / Front Wide

15 Use $\triangleleft \triangleright$ to select a front speaker, and then press ENTER.

- A** Select this to use front speaker A.
- B** Select this to use front speaker B.
- A+B** Select this to use front speakers A and B simultaneously.

16 Use $\triangleleft \triangleright$ to set whether or not a subwoofer channel is measured, and then press ENTER.

- Measure (2 spkrs)** Set for measuring two subwoofers (Audyssey Sub EQ HT™).
- Measure (1 spkr)** Set for measuring a subwoofer.
- Skip** Set for no measuring of a subwoofer.

17 Use $\triangleleft \triangleright$ to set whether or not a surround back channel is measured, and then press ENTER.

- Measure (2 spkrs)** Set for measuring two surround back speakers.
- Measure (1 spkr)** Set for measuring a surround back speaker.
- Skip** Set for no measuring of a surround back speaker.

18 Use $\triangleleft \triangleright$ to set whether or not a front height channel is measured, and then press ENTER.

- Measure** Set to measure the front height speakers.
- Skip** Set when you do not want to measure the front height speakers.

19 Use $\triangleleft \triangleright$ to set whether or not a front wide channel is measured, and then press ENTER.

- Measure** Set to measure the front wide speakers.
- Skip** Set when you do not want to measure the front wide speakers.

20 Press \triangleleft or BACK. Proceed to page 35 Preparation step 5.

NOTE

After performing Audyssey® Setup, do not change the speaker connections or subwoofer volume. In event of a change, perform Audyssey® Setup again.

Playback (Advanced operation)

Setup (👉 page 33)

Playback (Basic operation) (👉 page 41)

Selecting a listening mode (Sound Mode)
(👉 page 84)

- ❑ HDMI control function (👉 page 102)
- ❑ InstaPrevue function (👉 page 104)
- ❑ Sleep timer function (👉 page 105)
- ❑ Quick select function (👉 page 106)
- ❑ REC OUT mode (👉 page 107)
- ❑ Web control function (👉 page 108)
- ❑ Various memory functions (👉 page 110)

HDMI control function

If you connect the unit and an HDMI control function compatible TV or player with an HDMI cable and then enable the HDMI control function setting on each device, the devices will be able to control each other.

❑ Operations possible by HDMI control

- **This unit power off can be linked to the TV power off step.**
- **You can switch audio output devices with a TV operation.**
When you set "Output audio from amp" in the TV audio output setup operation, you can switch the amp power on.
- **You can adjust this unit volume in the TV volume adjustment operation.**
- **You can switch this unit input sources through linkage to TV input switching.**
- **When playing the player, this unit input source switches to the source for that player.**
- **If you switch the input source of the unit to "TV AUDIO", you can play TV audio with this unit (👉 page 10 "About ARC (Audio Return Channel) function").**
- **When "HDMI Control" (👉 page 130) in the menu is set to "On", signals input to the HDMI input connector are output to the television or other device connected to the HDMI output connector, even if the power of this unit is in standby (pass-through function).**



To use this unit to play the audio of a TV that does not support the ARC function, connect the TV with an optical-digital or analog connection (👉 page 10).

❑ Setting procedure

- 1 Set the HDMI output connector corresponding with the HDMI control function.**
Set "HDMI Control" (👉 page 130) to "On".
- 2 Turn the power on for all the devices connected by HDMI cable.**
- 3 Set the HDMI control function for all devices connected by HDMI cable.**
 - Please consult the operating instructions for the connected devices to check the settings.
 - Carry out steps 2 and 3 should any of the devices be unplugged.
- 4 Switch the television input to the HDMI input connected to this unit.**
- 5 Switch this unit input to the HDMI input source and check if the picture from the player is ok.**
- 6 When you turn the TV's power to standby, check that the power of this unit also goes to standby.**



If the HDMI control function does not operate properly, check the following points.

- Is the TV or player compatible with the HDMI control function?
- Is "HDMI Control" ([page 130](#)) set to "On"?
- Is "Power Off Control" ([page 131](#)) set to "All" or "Video"?
- Is "Control Monitor" ([page 130](#)) set for the monitor output connected to television?
- Is "Control Monitor" ([page 130](#)) set to the TV that uses the HDMI control function when this unit is connected to two TVs that support HDMI connectors?
- Are the HDMI control function settings of all devices correct?

NOTE

- **When "HDMI Control" is set to "On", it consumes more standby power.**
- The HDMI control function controls operations of a TV that is compatible with the HDMI control function. Make sure that the TV and HDMI are connected when you perform HDMI control.
- Some functions may not operate depending on the connected TV or player. Check the owner's manual of each device for details beforehand.
- When "Power Off Control" on the menu is set to "Off" ([page 131](#)), this unit is not set to standby even if the connected device is in the standby mode.
- When connection changes are implemented, such as adding connections to HDMI devices, linked operations may be initialized. In this case, you will need to reconfigure the settings.
- When "HDMI Control" is set to "On", it is not possible to assign an HDMI connector to "TV AUDIO" at "Input Assign" ([page 135](#)).
- Should any of the operations below be performed, the interlocking function may be reset, in which case, repeat steps 2 and 3.
 - "Input Assign" – "HDMI" ([page 135](#)) setting has changed.
 - "Video Output" ([page 130](#)) setting is changed.
 - There is a change to the connection between the devices and the HDMI, or an increase in devices.
- The HDMI ZONE4 function is compatible with the HDMI control function.
- The ARC function, Power Off Control function, and Volume Control function is not compatible with the HDMI ZONE4 control function.
- When the HDMI ZONE4 function is used with "HDMI Control" in the menu set to "On", the HDMI ZONE4 control function may not fully work.
- When the power in ZONE4 is on with "HDMI Control" ([page 130](#)) set to "On" and "Control Monitor" set to "Monitor 1" or "Monitor 2" ([page 130](#)), the following operations occur (Some example behaviors are listed below.).
 - When the power of the TV used for MAIN ZONE is off and the player selected for ZONE4 starts playback, the TV used for MAIN ZONE is turned on. In this case, the input source selected for MAIN ZONE changes to the input source selected for ZONE4.
 - When playing back a TV used for MAIN ZONE and ZONE4 with an HDMI connection, turning off the TV used for MAIN ZONE also turns off this unit and the player.
 - When a same input source is selected for MAIN ZONE and ZONE4, stopping playback of the player on the TV stops the playback on the player and the video being played back in ZONE4 as well.

- When the power in ZONE4 is on with "HDMI Control" ([page 130](#)) set to "On" and "Control Monitor" set to "ZONE4" ([page 130](#)), the following operations occur.
 - When the power of the TV used for ZONE4 is off and the player selected for MAIN ZONE starts playback, the TV used for ZONE4 is turned on. In this case, the input source selected for ZONE4 changes to the input source selected for MAIN ZONE.
 - When playing back a TV used for ZONE4 and MAIN ZONE with an HDMI connection, turning off the TV used for ZONE4 also turns off the player.
 - When a same input source is selected for ZONE4 and MAIN ZONE, stopping playback of the player on the TV stops the playback on the player and the video being played back in MAIN ZONE as well.

InstaPrevue function

You can display sub screens on the main screen to preview playback video of the HDMI input connected to this unit. You can also display various video inputs in a single screen to switch input sources such as Blu-ray, DVD, and GAME while viewing them on sub screens.



The InstaPrevue function is compatible with the HDMI1 – 6 connectors. It is not supported for the HDMI7 / MHL connectors.

Switching input sources

Switch to the desired input source on this unit while viewing sub screens.

1 Press ZONE SELECT to switch the zone mode.

The **M** indicator lights.

2 Press InstaPrevue.

The main screen (current input video) and sub screens (other input video) are displayed.

3 Use $\Delta \nabla \triangleleft \triangleright$ to select the desired input source from the sub screen, and press ENTER.

To operate devices with the remote control unit of this unit after selecting the input source:

While sub screens are displayed, press an input source select button to select the desired input source.



Before you can perform this operation, you must register preset codes for the remote control unit ([see page 157](#)).

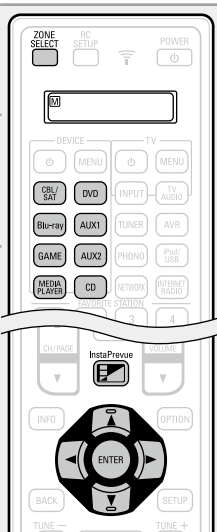

Setting how to display sub screens

You can select to display five sub screens or only one sub screen.

1 While sub screens are displayed, press OPTION.

The InstaPrevue setting screen is displayed.

2 Press $\triangleleft \triangleright$ in “HDMI Input” to select how to display sub screens.

All Displays five sub screens.

One at time Displays only one sub screen.

3 Press OPTION to enter the setting.



Changing the display location of sub screens

You can change the display location of sub screens to a desired location.

1 While sub screens are displayed, press OPTION.

The InstaPrevue setting screen is displayed.

2 Press ∇ to select “Location” and use $\triangleleft \triangleright$ to select the location where you want to display sub screens.

- The locations where sub screens can be displayed differ according to the “HDMI Input” setting.

When “HDMI Input” is set to “All”

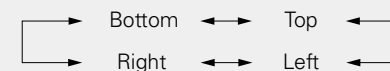

- The default setting is “Bottom”.

When “HDMI Input” is set to “One at time”



- The default setting is “Bottom Left”.

3 Press OPTION to enter the setting.

NOTE

- The InstaPrevue function is available when HDMI signals are input to the main screen. However, it is not available while computer's resolution (e.g. VGA) or 3D video contents is being played back.
- The InstaPrevue function is not available for the ZONE4 HDMI monitor output. It is also not available when the power in ZONE4 is on.

Sleep timer function

- You can have the power automatically switched to standby once a set time has elapsed. This is convenient for viewing and listening while going to sleep.
- The sleep timer function can be set for each zone ([page 113](#) “Sleep timer function”). (The MAIN ZONE setting method is explained here.)

1 Press ZONE SELECT to switch the zone mode.

The **M** indicator lights.

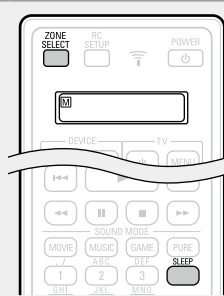

2 Press SLEEP and display the time you want to set.

The **S** indicator on the display lights.

- The time switches as shown below each time **SLEEP** is pressed.

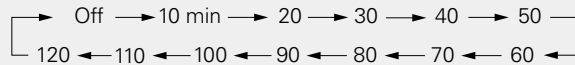

To confirm the countdown time before putting the unit to sleep

Press **SLEEP**.

“Sleep : *min” appears on the display.

* Countdown time

To cancel the sleep timer

Press **SLEEP** to set “Off”.

The **S** indicator on the display turns off.



- The sleep timer setting is canceled if this unit’s power is set to standby.
- The sleep timer function can be set separately for the different zones ([page 113](#) “Sleep timer function”).

NOTE

The sleep timer function cannot turn off the power of devices connected to this unit. To turn off the power of those connected devices, set up sleep timers on the connected devices themselves.

Quick select function

You can save settings such as the input source selection, volume level, and sound mode at the **QUICK SELECT 1 – 4** buttons.

You can simply press one of the set **QUICK SELECT** buttons for subsequent playback to switch to various saved settings all at once.

- By saving frequently used settings at the **QUICK SELECT 1 – 4** buttons, you will always be able to easily call up the same playback environment.

Press QUICK SELECT.

The Quick Select settings for the button you pressed are called up.

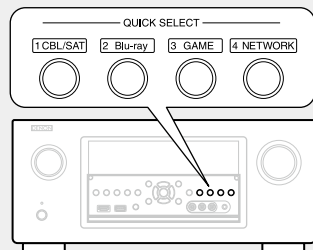

- The default settings of each Quick Select function are as shown below.

Button	Input source	Volume	Sound Mode
QUICK SELECT 1	CBL/SAT	40	STEREO
QUICK SELECT 2	Blu-ray	40	STEREO
QUICK SELECT 3	GAME	40	STEREO
QUICK SELECT 4	NETWORK	40	STEREO

Changing the Quick Select Name

On this unit, you can change the Quick Select Name displayed on the menu to the name that you prefer.

For the name change method, see “Quick Select Names” ([page 152](#)).

Changing the settings

1 Set the items below to the settings you want to save.

- ① Input source* ([page 41](#))
- ② Volume ([page 42](#))
- ③ Sound Mode ([page 84](#))
- ④ Audyssey
(Audyssey MultEQ® XT 32, Audyssey Dynamic EQ®, Audyssey Dynamic Volume®) ([page 125](#))

2 Press and hold the desired QUICK SELECT until “Quick* Memory” appears on the display.

The current settings will be memorized.

- * The number for the **QUICK SELECT** button you pressed is displayed.

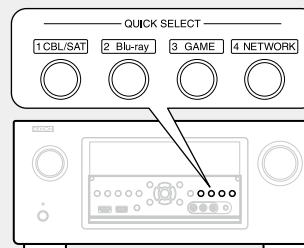

REC OUT mode

- When using the audio/video recording connectors (MEDIA PLAYER outputs), you can record the audio or video from a different program source while listening to the currently played track.
- For the connection method, see “Connecting a media player” ([page 22](#)).

1 Press **ZONE/REC SELECT** until “RECOUT Source” is displayed.

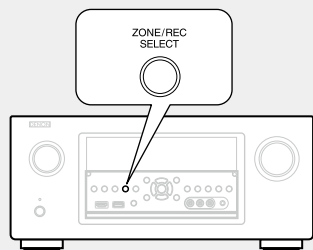

2 Press **ZONE/REC SELECT** to choose the input source to be recorded.

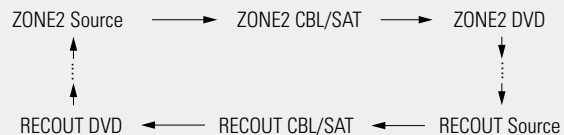

3 Start recording.

- For operating instructions, refer to the respective device’s operating instructions.



- To cancel, press **ZONE/REC SELECT** until “ZONE2 Source” is displayed.
- Make a test recording before starting the actual recording.
- Sources selected with the REC OUT mode are output from ZONE2 as well.
- The operable buttons on the remote control unit in REC OUT mode while it is in the operating mode for ZONE2 are as follows:
 - **ZONE SELECT** button
 - **MUTE** button (M)
 - **VOLUME** button (V)



NOTE

- Recordings you make are for your personal enjoyment and should not be used for other purposes without permission of the copyright holder.
- Input sources for which “Hide” is selected at “Hide Sources” ([page 137](#)) cannot be selected.
- To record video signals through this unit, use the video cable for connection between this unit and the player.
- Make an analog connection for audio signals.

Web control function

You can control this unit from a web control screen on a web browser.



- This unit and the PC need to be connected to the network properly (page 31 “Connecting to a home network (LAN)”) in order to use the web control function.
- Depending on the settings of your security-related software, you may not be able to access this unit from your PC. If this is the case, then change the settings of the security-related software.

1 Switch the “Network” setting to “Always On” (page 147).

2 Check the IP address of this unit with “Information” (page 147).

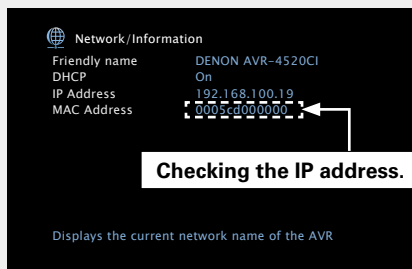

3 Start up the web browser.

4 Enter the IP address of this unit in browser’s address box.

For example, if the IP address of this unit is “192.168.100.19”, enter “http://192.168.100.19/”.

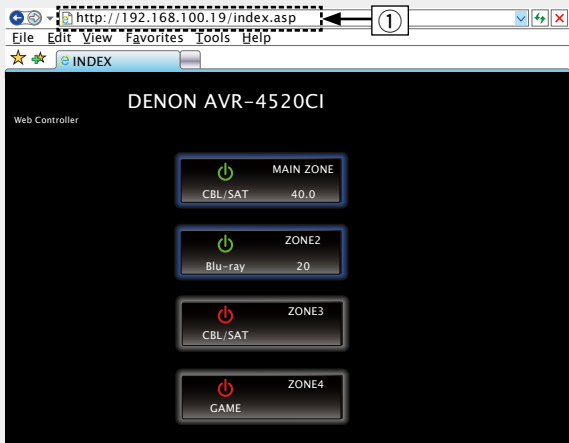

① Entering the IP address.

- By adding this unit’s IP address to the browser’s bookmark, you can display the web control screen using the bookmark function the next time you use the browser. If you are using a DHCP server and “Network” (page 147) is set to “Off In Standby”, turning the power on/off changes the IP address.

5 When the top menu is displayed, click on the menu item you want to operate.

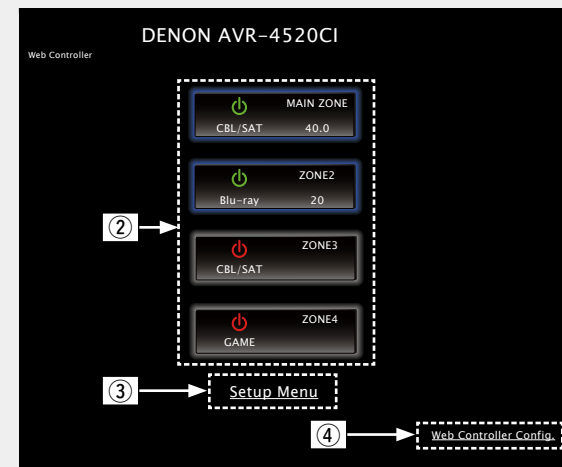

② Click when you select the zone to operate. (Example 1)

③ Click when you operate the setup menu. (Example 2)

④ Click to change the Web control screen setting. (Example 3)

6 Operate.

[Example 1] MAIN ZONE control screen

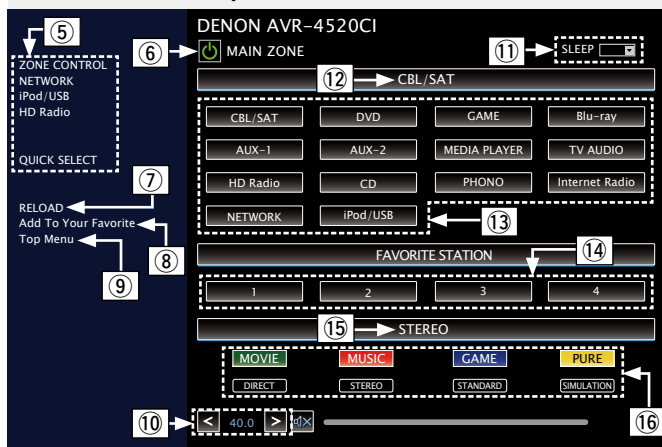

- ⑤ Click the menu item from which you want to make settings. The display on the right becomes the individual setting screens. (Example 4)
- ⑥ Click when you perform a power operation of the unit.
- ⑦ Click when you update to the latest information. Normally, there is a change to the latest information each time you operate. When operating from the main unit, click this or else the screen will not be updated.
- ⑧ Click to add a setting to "Favorites" in your browser. We recommend registering the setting screens for the different zones in the browser's favorites so as not to accidentally perform menu operations for zones you do not intend to operate.
- ⑨ Click to return to the top menu. Displayed when setting "Top Menu Link Setup" to "ON" in [Example 3]
- ⑩ To adjust the main volume, click "<", ">", or the volume display.
- ⑪ Click "v" to set the sleep timer function.
- ⑫ Displays the name of the selected input source.
- ⑬ Click a button to change the input source.
- ⑭ Register your favorite content.
- ⑮ Displays the sound mode.
- ⑯ The sound mode switches you click the button.

[Example 2] Setup menu screen

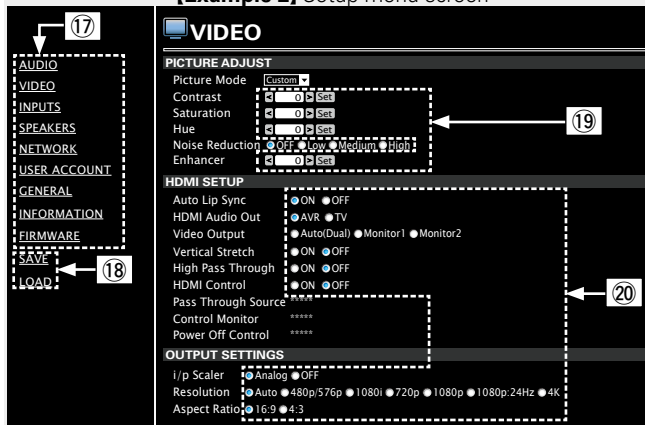

- ⑰ Click the menu item from which you want to make settings. The display on the right becomes the individual setting screens.
- ⑱ Click "SAVE" when you want to save settings, and click "LOAD" when you want to call settings.
- ⑲ Enter figures or click "<" or ">" to make the setting, and then click "Set".
- ⑳ Click an item to make a setting.

[Example 3] Web configuration screen



- ⑳ Click "ON" when performing Top Menu Link Setup. When set up, return to the top menu from each operation screen. (Default setting : "OFF")
- ㉑ Click this item to return to the top menu.

[Example 4] Network audio operating screen

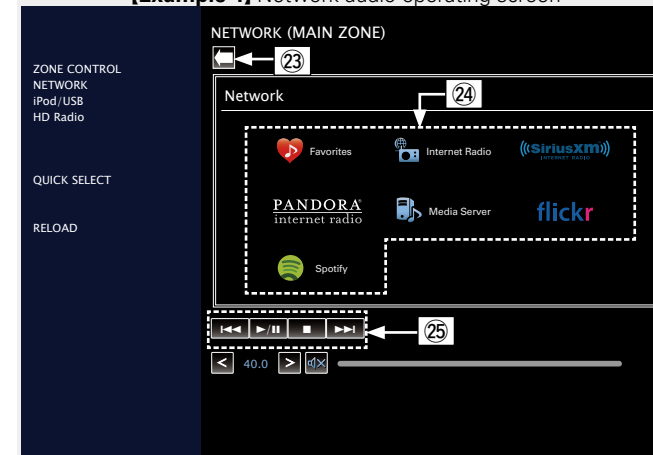

- ㉓ Click to return to the previous screen.
- ㉔ Click the content you want to operate.
- ㉕ Use to operate content.

Various memory functions

Personal memory plus function

This function sets the settings (input mode, sound mode, HDMI output mode, MultEQ® XT 32, Dynamic EQ, audio delay etc.) last selected for the individual input sources.



The surround parameters, tone settings and the volumes of the different speakers are stored for the individual sound modes.

Last function memory

This function stores the settings which were made before going into the standby mode. When the power is turned back on, the settings are restored.

Playback in ZONE2/ZONE3/ZONE4 (Separate room)

- You can operate this unit so as to enjoy audio in a room (ZONE2, ZONE3 and ZONE4) other than the MAIN ZONE (room where the unit is located).
- You can simultaneously play back the same source in both the MAIN ZONE, ZONE2, ZONE3 and ZONE4. You can also play back separate sources in the MAIN ZONE, ZONE2, ZONE3 and ZONE4.
- When a TV is connected to the HDMI ZONE4 OUT connector, you can play back a video or audio from the device connected to the HDMI 1 – 6 IN connector in ZONE4 (**HDMI ZONE4 function**).



The source selected for ZONE2 is also output from the recording output connectors (MEDIA PLAYER).

NOTE

The following restrictions apply to the HDMI ZONE4 function.

- If you select a same input source for MAIN ZONE and ZONE4, audio playback may be restricted or video may be interrupted.
- Video may not be output depending on the resolution of the TV used for MAIN ZONE and ZONE4. In this case, use your player to set the resolution of the TV.
- When HDMI ZONE4 function is used, you cannot set the following.
 - Picture Adjust
 - Auto Lip Sync
 - Video Mode
 - Video Conversion
 - i/p Scaler
 - Progressive Mode
 - Aspect Ratio
 - Setup menu display

Audio output

It is possible to play 2-channel audio in rooms other than the MAIN ZONE where multi-channel playback is done. Choose one of the methods.

- ① Zone playback by speaker output
- ② Zone playback by audio output (PRE OUT)
Use an external amplifier.

① Zone playback by speaker output

- When “Assign Mode” ([page 141](#)) in the menu is set to any of the following, audio is output from speakers in ZONE2 or ZONE3.
 - 7.1ch + ZONE2
 - 7.1ch + ZONE2/3-MONO
 - 5.1ch + ZONE2/3
 - 5.1ch(Bi-Amp) + ZONE2

Also, connectors that ZONE2 or ZONE3 speakers are connected to differ according to the “Main Speakers” ([page 141](#)) setting.

❑ Connecting and setting the speakers

“Assign Mode” setting (page 141) and audio signals output	Connecting the speakers
<p>7.1ch + ZONE2 5.1ch(Bi-Amp) + ZONE2</p> <p>Output signal : Stereo (L / R)</p>	
<p>5.1ch + ZONE2/3</p> <p>Output signal : Stereo (L / R)</p>	
<p>7.1ch + ZONE2/3-MONO</p> <p>Output signal : Monaural</p>	

② Zone playback by audio output (PRE OUT)

□ Audio connections (ZONE2, ZONE3)

The audio signals of this unit's ZONE2 and ZONE3 audio output terminals are output to the ZONE2 and ZONE3 amplifiers and played on these amplifiers.

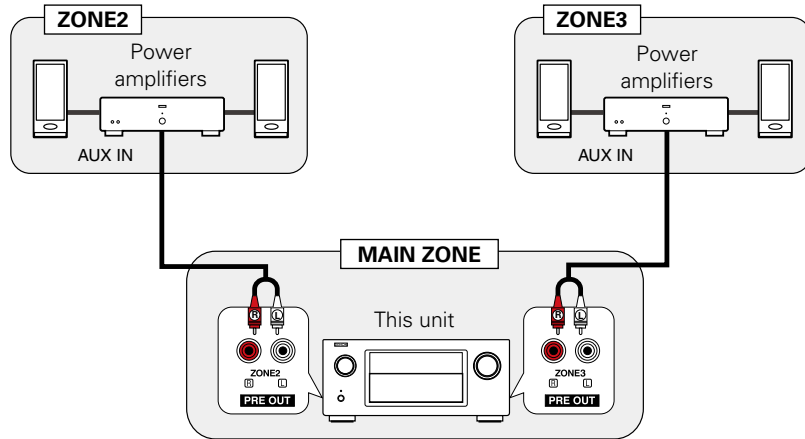

We recommend using high quality pin-plug cables for audio connections in order to prevent noise.

NOTE

In ZONE2 or ZONE3, the digital audio signals input from the HDMI, COAXIAL or OPTICAL connector cannot be played back. When playing back in ZONE2 or ZONE3, make an analog connection, network or iPod/USB.

Video output

Video Connection

The video signals of this unit's ZONE4 video output connector are played by the ZONE4 TV.

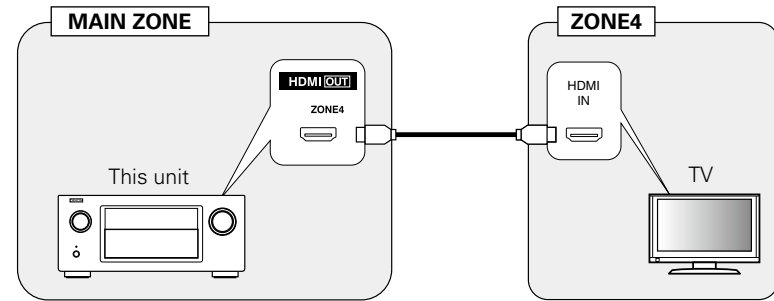

The video signals of this unit's ZONE2 video output connector are played by the ZONE2 TV.

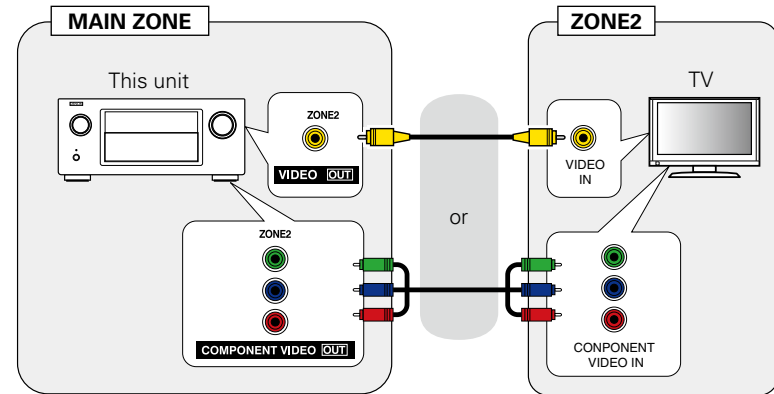

- When "Analog Video Out" ([page 132](#)) in the menu is set to "ZONE3", you can use the COMPONENT VIDEO OUT and the VIDEO MONITOR OUT connectors in MAIN ZONE for ZONE3.
- To enable the HDMI control for the ZONE4 HDMI monitor, set "Control Monitor" ([page 130](#)) to "ZONE4".

Playback

1 Press ZONE SELECT to switch the zone mode.

The [Z2], [Z3] or [Z4] indicator lights.

2 Press POWER to turn on the ZONE2, ZONE3 or ZONE4 power.

- Also press input source select button when in standby mode, the power turns on.
- When POWER is pressed, ZONE2, ZONE3 or ZONE4 turns off.
- Power in ZONE2, ZONE3 or ZONE4 can be turned on or off by pressing ZONE2 ON/OFF, ZONE3 ON/OFF or ZONE4 ON/OFF on the main unit.

3 Press the input source select button to select the input source to be played.

The audio and video signal of the selected source is output to ZONE2, ZONE3 or ZONE4.

- Turn SOURCE SELECT after pressing ZONE/REC SELECT on the main unit to select an input source.

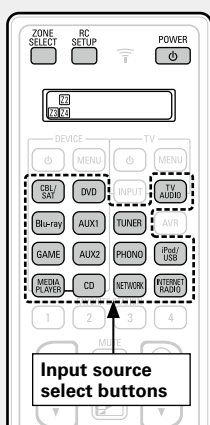

When power for both MAIN ZONE and ZONE2 (ZONE3 or ZONE4) is set to ON, power of the MAIN ZONE only can be turned off. Select MAIN ZONE in step 1 then press POWER.

Adjusting the volume

Use VOLUME to adjust the volume.



[Adjustable range] 0 – 40 – 98

(When the “Scale” (page 124) setting is “0 – 98”)

[Adjustable range] --- –79dB – –40dB – 18dB

(When the “Scale” (page 124) setting is “–79.5dB – 18.0dB”)

- At time of purchase, “Volume Limit” (page 151) is set to “70 (–10dB)”.



Turn MASTER VOLUME after pressing ZONE/REC SELECT on the main unit to adjust the sound volume.

NOTE

For ZONE4, you cannot use VOLUME to adjust the volume level.

Turning off the sound temporarily

Press MUTE.

The sound is reduced to the level set at “Mute Level” (page 151) in the menu.

- To cancel, either adjust the volume or press MUTE again.
- The setting can also be cancelled by adjusting the volume or turning off the ZONE2 or ZONE3 power.



You can adjust the tone and volume for ZONE2 or ZONE3 in “ZONE2 Setup” or “ZONE3 Setup” (page 151) in the menu.

- The All Zone Stereo function allows you to simultaneously enjoy in multi-zones (ZONE2/ZONE3) the music that is played back in MAIN ZONE during home party, etc. (page 80 “All Zone Stereo function”).

Sleep timer function

- This is convenient for viewing and listening while going to sleep in ZONE2, ZONE3 or ZONE4.
- The sleep timer function can be set by zone.

1 Press ZONE SELECT to switch the zone mode.

The [Z2], [Z3] or [Z4] indicator lights.

2 Press SLEEP and display the time you want to set.

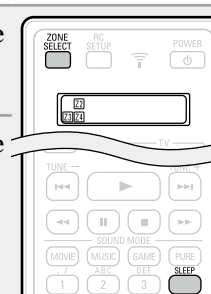

- The time switches as shown below each time SLEEP is pressed.

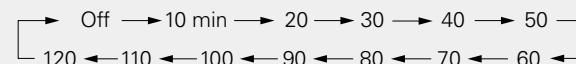

To confirm the countdown time before putting the unit to sleep

Press SLEEP.

“Z2 Sleep : *min”, “Z3 Sleep : *min” or “Z4 Sleep : *min” appears on the display.

* Countdown time

To cancel the sleep timer

Press SLEEP to set “Off”.



The sleep timer is also cancelled when this unit is set to the standby mode or the ZONE2, ZONE3 or ZONE4 power is turned off.

NOTE



The sleep timer function cannot turn off the power of devices connected to this unit. To turn off the power of those connected devices, set up sleep timers on the connected devices themselves.



How to make detailed settings



Menu map

For menu operation, connect a TV to this unit and display the menu on the TV screen. For menu operations, see the following page.

By default, this unit has recommended settings defined. You can customize this unit based on your existing system and your preferences.

Setting items	Detailed items	Description	Page
 Audio	Dialog Enhancer	Adjusts and enhances the frequency band corresponding to the human voice at the center channel to make the voice clearer.	121
	Subwoofer Level	This setting adjusts the volume level for the subwoofer.	121
	Surround Parameter	Adjusts surround sound parameters.	121
	Tone	Adjusts the tonal quality of the sound.	123
	Restorer	Expands the low and high frequency components of compressed audio to enable richer audio playback.	124
	Audio Delay	Compensates for incorrect timing between video and audio.	124
	Volume	Set the MAIN ZONE (room where the unit is located) volume setting.	124
	Audyssey	Makes Audyssey MultEQ [®] XT 32, Audyssey Dynamic EQ [®] , Audyssey Dynamic Volume [®] , Audyssey LFC [™] and Audyssey DSX [®] settings.	125
	Graphic EQ	Uses the graphic equalizer to adjust the tone of each speaker.	127
 Video	Picture Adjust	Adjusts the video quality.	129
	HDMI Setup	Makes settings for HDMI video/audio output.	129
	Output Settings	Makes screen-related settings.	131
	Analog Video Out	Assigns the zone that uses the VIDEO MONITOR OUT connectors.	132
	On Screen Display	Select the on-screen display user interface preferences.	133
	TV Format	Set the video signal format to be output for the TV you are using.	133

Setting items	Detailed items	Description	Page
 Inputs	Input Assign	Changes input connector assignment.	135
	Source Rename	Changes the display name for this source.	137
	Hide Sources	Remove from the display input sources that are not used.	137
	Source Level	Adjusts the playback level of the audio input.	137
	Input Select	Sets the audio input mode and decode mode.	138
	Video Source	Video of another input source is played back combined with the playing audio.	138
 Speakers	Audyssey[®] Setup	The acoustic characteristics of the connected speakers and listening room are measured and the optimum settings are made automatically.	33 , 99
	Manual Setup	Perform when setting the speakers manually or when changing settings made in Audyssey [®] Setup.	141
 Network	Information	Display network information.	147
	Network	Enables network communication in standby power mode.	147
	Friendly Name	The Friendly Name is the name of this unit displayed on the network. You can change the Friendly Name according to your preferences.	147
	Settings	Make settings for wired LAN.	148
	Diagnostics	Used to check the network connection.	149
	Maintenance Mode	Use when receiving maintenance from a DENON service engineer or custom installer.	149

Setting items	Detailed items	Description	Page
 General	Language	Sets the language for display the menu on the TV screen.	151
	ZONE2 Setup	Makes settings for audio playback in a ZONE2 system.	151
	ZONE3 Setup	Makes settings for audio playback in a ZONE3 system.	151
	Zone Rename	Change the display title of each zone to one you prefer.	152
	Quick Select Names	Change the “Quick Select” display title to one you prefer.	152
	Remote ID	Specifies with remote control code set this AVR will respond to.	152
	Trigger Out 1	Selects when to activate trigger out 1.	152
	Trigger Out 2	Selects when to activate trigger out 2.	152
	Auto Standby	When you do not perform any operation on this unit with no audio or video input for a specified time, this unit automatically enters the standby mode. Before it enters the standby mode, “Auto Standby” is displayed on the display of this unit and the menu screen.	153
	Front Display	Makes settings related to the display on this unit.	153
	Information	Show information about receiver settings, input signals, etc.	153
Firmware	Set whether or not to check for firmware update, update the firmware, and display update and upgrade notifications.	154	
Setup Lock	Protect settings from inadvertent change.	156	
 Setup Assistant	Perform the installation, connection, and setup procedures to prepare the unit for operation following guidance.	 7	

Examples of menu screen displays

Typical examples are described below.

[Example 1]

Menu selection screen (Top menu)

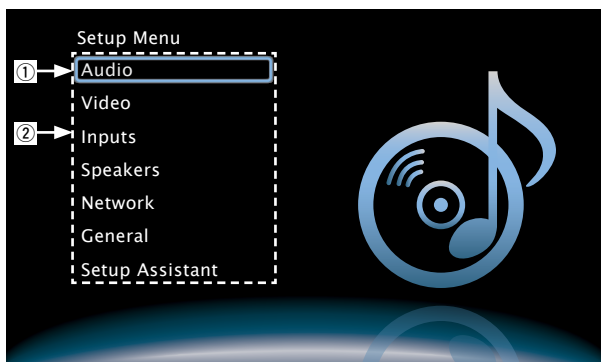

- ① Currently selected setup item
- ② List of GUI menu setup items

Use Δ / ∇ to select "Audio" and then press \triangleright .
(Or press ENTER.)

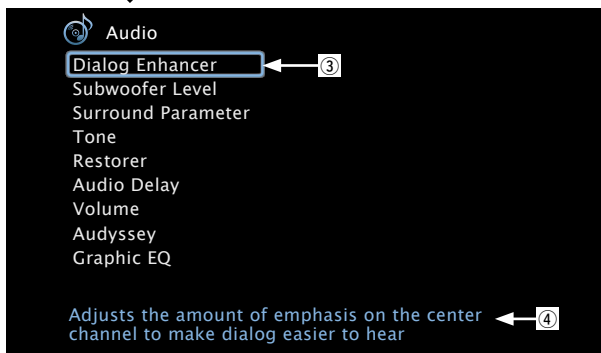

- ③ Selected setup item
- ④ Guide text for the currently selected setup item

[Example 2]

Audyssey® Setup screen (with illustration)

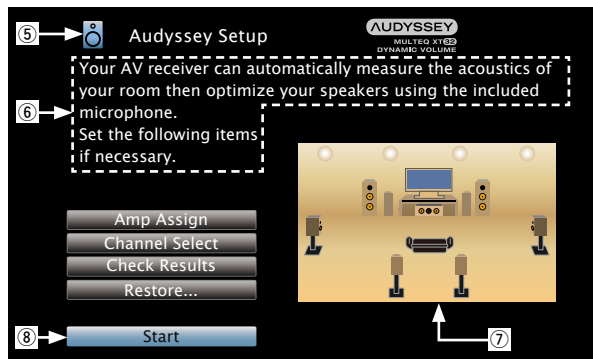







- ⑤ Currently selected setup icon
- ⑥ Operation guidance text
- ⑦ Illustration
- ⑧ Selected setup item

NOTE

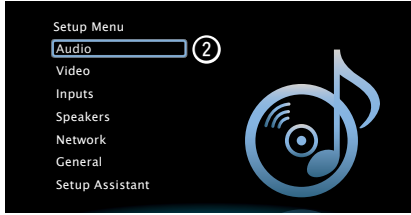
When the menu is operated on a computer's resolution (e.g. VGA) or during playback of certain 3D video content, the playback image switches to the menu screen image.

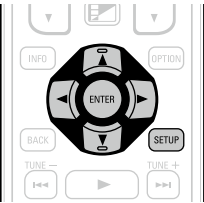
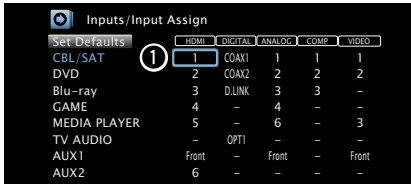
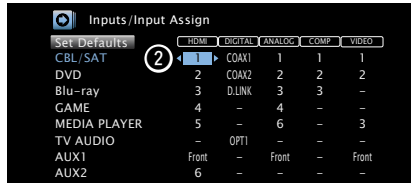
Examples of menu and front display

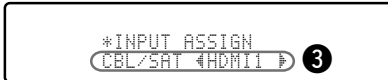
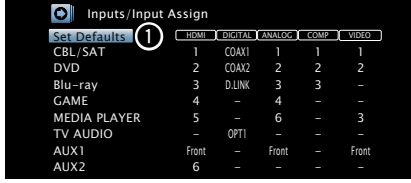
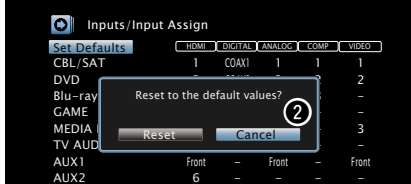
Below we describe typical examples of displays on the TV screen and on the set's display window.

	Menu display	Front display	Description
Top menu display			<ol style="list-style-type: none"> 1 Press SETUP to display the menu screen. 2 TV screen: Displays the selected line. Display: Displays the selected item. <ul style="list-style-type: none"> • Use Δ/∇ to move to the item you want to set. 
Display when changing settings	 <p>Press ENTER.</p> 	 <p>Press ENTER.</p> 	<ol style="list-style-type: none"> 1 TV screen: Displays the selected line. Display: Displays the selected item. 2 Press ENTER to set to the mode in which the setting can be made. <ul style="list-style-type: none"> • Use Δ/∇ to move to the item you want to set. <ol style="list-style-type: none"> 3 \blacktriangleleft \blacktriangleright is displayed at the sides of items whose setting can be changed. Use \blacktriangleleft/\blacktriangleright to change to the desired setting.
Display when returning to the settings in effect at time of purchase	 <p>Press ENTER.</p> 	 <p>Press ENTER.</p> 	<ol style="list-style-type: none"> 1 Press Δ to select "Set Defaults" or "Default", then press ENTER. 2 Press \blacktriangleleft to select "Reset", then press ENTER.

Inputting characters

On this unit, you can change the name displayed on the following screens to the names that you prefer.

- Text Search (🔗 [page 76](#))
- Preset Name (🔗 [page 56](#))
- Source Rename (🔗 [page 137](#))
- Friendly Name (🔗 [page 147](#))
- Zone Rename (🔗 [page 152](#))
- Quick Select Names (🔗 [page 152](#))
- Character input for the network functions (🔗 [page 59, 67, 69, 72, 74, 148](#))

Method for inputting characters

Method	Operations
Using the keyboard screen	• Select a character on the TV screen to input characters.
Using the number buttons (10 Key input screen)	• Multiple characters are assigned to a button, and each time the button is pressed, a character is switched.
Using the cursor buttons (10 Key input screen)	• Use $\Delta \nabla \triangleleft \triangleright$ and ENTER to input characters.

Keyboard screen

Select a character on the TV screen to input characters.

Input method

1 Display the screen for inputting characters (🔗 [page 114](#) “Menu map”).

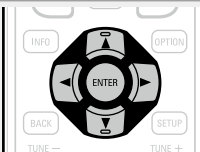

2 Select a character to be changed.

- ① Use $\Delta \nabla \triangleleft \triangleright$ to select **←** or **→**.
- ② Press **ENTER** to place the cursor at the character to be changed.
Each time **ENTER** is pressed, the cursor moves by one character.

3 Select a character to be input with $\Delta \nabla \triangleleft \triangleright$ then press **ENTER**.

- The types of characters that can be input are as shown below.

[Upper case characters/Numbers/Symbols]
 ABCDEFGHIJKLMNOPQRSTUVWXYZ
 0123456789
 ! " # \$ % & ' () * + , ; < = >
[Lower case characters/Numbers/Symbols]
 abcdefghijklmnopqrstuvwxyz
 0123456789
 . @ _ / : ~ ? [\] ^ ' { | }

4 Repeat steps 2 and 3 to change the name.

5 Use $\Delta \nabla \triangleleft \triangleright$ to select **OK**, then press **ENTER**.

10 Key input screen

Display of a 10 Key input screen

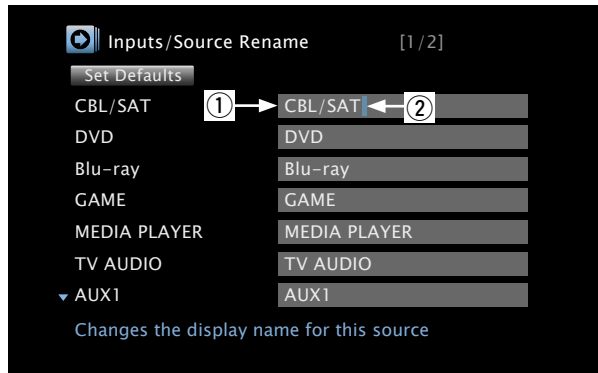

- ① Character input section
- ② Cursor

Input method

Using the number buttons

- 1** When the keyboard screen is displayed, press **0 – 9**.
The 10 key input screen is displayed.

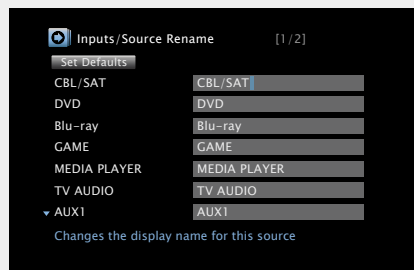

- 2** Place the cursor at the character to be changed with $\triangleleft \triangleright$ and press the number button (**0 – 9**) until the desired character is displayed.

- The types of characters that can be input are as shown below.

1 ABC	1. @ - _ / : ~	MNO	MNOmno6
2 DEF	ABCabc2	PQRS	PQRSpqrs7
3 GHI	DEFdef3	TUV	TUVtuv8
4 JKL	GHIghi4	WXYZ	WXYZwxyz9
5	JKLjkI5	0	0 (Space) ! " # \$ % & ' () * + , ; < = > ? [\] ^ _ { } ~

- For entering the characters assigned to one number button continuously, press \triangleright to move the cursor to the right after entering a character then enter the next character.
- For entering characters assigned to separate buttons, press the number button continuously. The cursor automatically moves to the next position, and the entered character is registered.

- 3** Repeat step 2 to change the name then press **ENTER** to register it.

Example: For changing the input source from "DVD" to "D&M"

- ① Place the cursor at "V". D**V**D

- ② Press **0** eight times.
"V" changes to "&". D**&**D

- ③ Press **6**.
"&" is automatically registered, and "D" changes to "M". D**&**M

- ④ Press **ENTER** to register the input source name.

Using the cursor buttons

- 1** When the keyboard screen is displayed, press **0 – 9**.

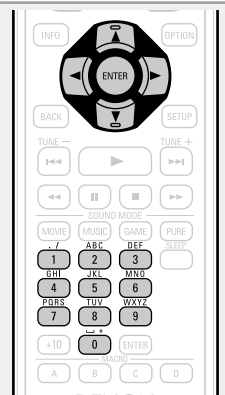
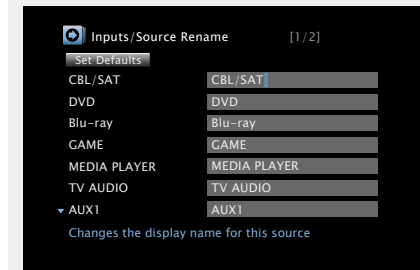

- 2** Use $\triangleleft \triangleright$ to set the cursor to the character.

- 3** Use $\triangle \nabla$ to change the character.

- The types of characters that can be input are as shown below.

[Upper case characters] ABCDEFGHIJKLMNOPQRSTUVWXYZ
[Lower case characters] abcdefghijklmnopqrstuvwxyz
[Symbols] ! " # \$ % & ' () * + , - . / : ; < = > ? @ [\] ^ _ ` { } ~
[Numbers] 0123456789 (Space)

- 4** Repeat steps 2 and 3 to change the name then press **ENTER** to register it.



Make audio-related settings.

Menu operation

- 1** Press **ZONE SELECT** to switch the zone mode.
The **[M]** indicator lights.
 - 2** Press **SETUP**.
The menu is displayed on the TV screen.
 - 3** Use **Δ**/**∇** to select the menu to be set or operated.
 - 4** Press **ENTER** or **▷** to enter the setting.
- To return to the previous item, press **◀** or **BACK**.
 - Exiting the Menu, press **SETUP** while the menu is displayed.
The menu display disappears.

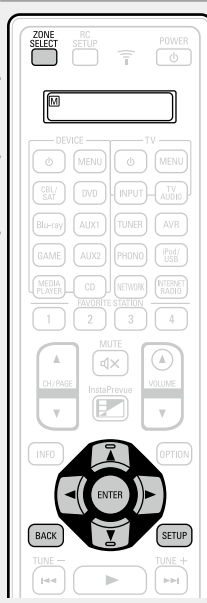

Items that can be set with the “Audio” procedure

Dialog Enhancer (👉 [page 121](#))

Subwoofer Level (👉 [page 121](#))

Surround Parameter (👉 [page 121](#))

Tone (👉 [page 123](#))

Restorer (👉 [page 124](#))

Audio Delay (👉 [page 124](#))

Volume (👉 [page 124](#))

Audyssey (👉 [page 125](#))

Graphic EQ (👉 [page 127](#))

Dialog Enhancer

Default settings are underlined.

Adjusts and enhances the frequency band corresponding to the human voice at the center channel to make the voice clearer.

Setting items	Setting details
Enhancer	Low / Medium / High : Enhances the human voice. Off : Does not enhance the human voice.

Subwoofer Level

Default settings are underlined.

This setting adjusts the volume level for the subwoofer.

Setting items	Setting details
Subwoofer 1 Level This setting adjusts the volume level for the subwoofer 1.	-12dB – +12dB (0dB)
Subwoofer 2 Level This setting adjusts the volume level for the subwoofer 2.	-12dB – +12dB (0dB)
Subwoofer Turn subwoofer output on and off.	On : The subwoofer is used. Off : The subwoofer is not used. NOTE This can be set when the sound mode is "DIRECT" and "PURE DIRECT" (page 84) and the "Subwoofer Mode" (page 144) is "LFE+Main".

Surround Parameter



Default settings are underlined.



You can adjust the surround audio sound field effects to match your preferences.



The items (parameters) that can be adjusted depend on the signal being input and the currently set sound mode. For details on the adjustable parameters, see "Sound modes and surround parameters" ([page 184](#)).

NOTE

- Some setting items cannot be set while playback is stopped. Make the settings during playback.
- When the sound mode is "PURE DIRECT", you cannot set the surround parameters.

Setting items	Setting details
Cinema EQ Softens the treble range of movie soundtracks for better understanding.	On : "Cinema EQ" is used. Off : "Cinema EQ" is not used.
Loudness Management This can be set in the Dolby TrueHD mode. This sets whether to output as specified in "Dynamic Compression" or output directly without compressing the dynamic range of audio recorded in the disc.	On : Outputs using the settings made in "Dynamic Compression" and "Dialogue normalization" (page 153) are enabled. Off : "Dynamic Compression" settings and "Dialogue normalization" are disabled, and the signals on the disc are output as is.
Dynamic Compression Compress dynamic range (difference between loud and soft sounds).	Auto : Automatic dynamic range compression on/off control according to source. Low / Medium / High : These set the compression level. Off : Dynamic range compression always off.  You can set "Auto" only for the Dolby TrueHD source.
Bass Sync For contents recorded in multi-channel such as Blu-ray discs, the recorded low frequency effects (LFE) may be out of synch and delayed. This function corrects such a delay of low frequency effects (LFE).	0ms – 16ms  How low frequency effects (LFE) are delayed differ according to the disc. Set this to the desired value.

Setting items	Setting details
<p>Low Frequency Effects Adjust the low-frequency effects level (LFE).</p>	<p><input type="checkbox"/> When "Input Mode" (🔗 page 138) is set other than to "EXTERNAL IN" -10dB - 0dB</p> <p><input type="checkbox"/> When "Input Mode" (🔗 page 138) is set to "EXTERNAL IN" 0dB / 5dB / 10dB / 15dB</p> <p> For proper playback of the different sources, we recommend setting to the values below.</p> <ul style="list-style-type: none"> • Dolby Digital sources : 0dB • DTS movie sources : 0dB • DTS music sources : -10dB
<p>Center Gain Distributes the dialogue output from the center channel to the front left and right channels and widens the sound image in the front. You can set this when the sound mode is set to DTS NEO:X.</p>	<p>0.0 - 1.0</p>
<p>Panorama Assign front L/R signal also to surround channels for wider sound. You can set this when the sound mode is Dolby PLII in the "Music" mode.</p>	<p>On : Set. Off : Do not set.</p>
<p>Dimension Shift sound image center to front or rear to adjust playback balance. You can set this when the sound mode is Dolby PLII in the "Music" mode.</p>	<p>0 - 6 (3)</p> <p> As you set a smaller number, the surround sound field shifts backward; as you set a larger number, the surround sound field shifts forward.</p>

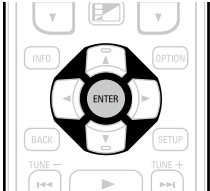

Setting items	Setting details
<p>Center Width Distributes the dialogue output from the center channel to left and right channels and widens the sound image in the front. You can set this when the sound mode is Dolby PLIIx in the "Music" mode.</p>	<p>0 - 7 (3)</p> <p> The smaller the value, the more dialogue is concentrated on the center channel. The larger the value, the more dialogue is distributed to front left and right channels, and the more the sound image widens in the front.</p>
<p>Delay Time Adjust the audio delay time against video to extend the sound field image. You can set this when the sound mode is "MATRIX".</p>	<p>0ms - 300ms (30ms)</p>
<p>Effect Level Adjust the sound effect level. You can set this when the sound mode is original listening mode.</p>	<p>1 - 15 (10)</p> <p> Set to a lower level if the positioning and sense of phase of the surround signals seems unnatural.</p>
<p>Room Size Determine size of acoustic environment. You can set this when the sound mode is original listening mode.</p>	<p>Small : Simulate acoustics of a small room. Medium small : Simulate acoustics of a medium-small room. Medium : Simulate acoustics of a medium room. Medium large : Simulate acoustics of a medium-large room. Large : Simulate acoustics of a large room.</p> <p>NOTE</p> <p>"Room Size" does not indicate the size of the room in which sources are played.</p>

Setting items	Setting details
Height Gain Control the front height channel volume.	<p>Low : Reduce the front height channel volume. Normal : Front height channel sound is output with standard sound volume. High : Increase the front height channel volume.</p> <p>NOTE</p> <p>"Height Gain" is displayed for the following settings.</p> <ul style="list-style-type: none"> When the "Speaker Config." – "Front Height" setting (page 142) is set other than to "None". When sound mode is "PLIIz" or the PLIIz decoder is used.
Speaker Select Makes settings for the speakers outputting sound.	<p>❑ When "Assign Mode" (page 141) is set to "7.1ch + ZONE2/3-MONO" and "7.1ch(Bi-Amp)" Surround Back : Sound is output from the surround back speakers. Height : Sound is output from the front height speakers. Wide : Sound is output from the front wide speakers.</p> <p>❑ When "Assign Mode" (page 141) is set to "9.1ch(SB/FH/FW)" Back/Height : Sound is output from the surround back and front height speakers. Back/Wide : Sound is output from the surround back and front wide speakers. Height/Wide : Sound is output from the front height and front wide speakers.</p> <p>NOTE</p> <p>Only speakers that are set to something other than "None" in "Speaker Config." (page 142) can be selected.</p>
Set Defaults The "Surround Parameter" settings are returned to the default settings.	<p>Reset : Reset to the defaults. Cancel : Do not reset to the defaults.</p> <p> When you select "Set Defaults" and press ENTER, the "Reset all surround parameters to the factory defaults?" prompt is displayed. Select either "Reset" or "Cancel", and press ENTER.</p> 

Tone

Default settings are underlined.

Adjust the tonal quality of the sound.

Setting items	Setting details
Tone Control Set the tone control function to "On" and "Off".	<p>On : Allow tone adjustment (bass, treble). Off : Playback without tone adjustment.</p> <p> "Tone Control" can be set when "Dynamic EQ" (page 125) is set to "Off".</p> <p>NOTE</p> <ul style="list-style-type: none"> "Tone Control" settings are not reflected to ZONE2 and ZONE3. The tone cannot be adjusted in the "DIRECT" and "PURE DIRECT" mode.
Bass Adjust bass.	<p>-6dB – +6dB (0dB)</p> <p> "Bass" can be set when the menu "Tone Control" setting is "On".</p>
Treble Adjust treble.	<p>-6dB – +6dB (0dB)</p> <p> "Treble" can be set when the menu "Tone Control" setting is "On".</p>

Restorer

Compressed audio formats such as MP3, WMA (Windows Media Audio) and MPEG-4 AAC reduce the amount of data by eliminating signal components that are hard for the human ear to hear. The “Restorer” function generates the signals eliminated upon compression, restoring the sound to conditions near those of the original sound before compression. It also corrects the sense of volume of the bass to obtain richer sound with compressed audio signals.

Setting items	Setting details
Mode Set the mode for “Restorer”.	<p>Mode 1 (High) : Optimized mode for compressed sources with very weak highs (64 kbps and under).</p> <p>Mode 2 (Middle) : Apply suitable bass and treble boost for all compressed sources (96 kbps and under).</p> <p>Mode 3 (Low) : Optimized mode for compressed sources with normal highs (96 kbps and over).</p> <p>Off : Do not use “Restorer”.</p>  <ul style="list-style-type: none"> This item can be set with analog signals or PCM signal (Sample Rate = 44.1/48 kHz) is input. “Restorer” settings are stored for each input source. This item default setting for “NETWORK” and “iPod/USB” is “Mode 3 (Low)”. All others are set to “Off”. This cannot be set when the sound mode is set to “DIRECT” or “PURE DIRECT”.

Audio Delay

Default settings are underlined.

While viewing video, manually adjust the time to delay audio output.

Setting details

0ms – 200ms



- This item can be set within the range of 0 to 100 ms when “Auto Lip Sync” ([page 129](#)) is set to “On” and when a TV compatible with Auto Lip Sync is connected.
- Store “Audio Delay” for each input source.
- Audio Delay for game mode can be set when “Video Mode” ([page 131](#)) is set to “Auto” or “Game”.

Volume

Default settings are underlined.

Set the MAIN ZONE (room where the unit is located) volume setting.

Setting items	Setting details
Scale Set how volume is displayed.	<p>0 – 98 : Display in the range 0 (Min) to 98.</p> <p>-79.5dB – 18.0dB : Display --dB (Min), in the range -79.5 dB to 18.0 dB.</p>  <ul style="list-style-type: none"> The “Scale” setting is applied also to the “Limit” and “Power On Level” display method. The “Scale” setting applies to all zones.
Limit Make a setting for maximum volume.	<p>60 (-20dB) / 70 (-10dB) / 80 (0dB)</p> <p>Off : Do not set a maximum volume.</p>
Power On Level Define the volume setting that is active when the power is turned on.	<p>Last : Use the memorized setting from the last session.</p> <p>Mute : Always use the muting on condition when power is turned on.</p> <p>1 – 98 (-79dB – 18dB) : The volume is adjusted to the set level.</p>
Mute Level Set the amount of attenuation when muting is on.	<p>Full : The sound is muted entirely.</p> <p>-40dB : The sound is attenuated by 40 dB down.</p> <p>-20dB : The sound is attenuated by 20 dB down.</p>

Audyssey

Default settings are underlined.

Set Audyssey MultEQ® XT 32, Audyssey Dynamic EQ®, Audyssey Dynamic Volume®, Audyssey LFC™ and Audyssey DSX®. These can be selected after Audyssey® Setup has been performed. For additional information on Audyssey technology, please see [page 193](#).



NOTE



- If you have not performed Audyssey® Setup, or if you change the speaker settings after performing Audyssey® Setup, you may not be able to select Dynamic EQ/Dynamic Volume. In this case, either perform Audyssey® Setup over again or perform “Restore...” ([page 40](#)) to return to the settings after Audyssey® Setup was run.
- When HD Audio for which the sampling frequency exceeds 96 kHz is played back, the “Audyssey” cannot be set.

Setting items	Setting details
MultEQ®XT 32 MultEQ® XT 32 compensates for both time and frequency characteristics of the listening area based on Audyssey® Setup measurement results. Selection is done from three types of compensation curves. We recommend the “Audyssey” setting. MultEQ® XT 32 is the prerequisite function for Dynamic EQ, Dynamic Volume and Audyssey LFC™.	<p>Audyssey : Optimize the frequency response of all speakers.</p> <p>Audyssey Byp. L/R : Optimize frequency response of speakers except front L and R speakers.</p> <p>Audyssey Flat : Optimize frequency response of all speakers to flat response.</p> <p>Graphic EQ : Apply frequency response set with “Graphic EQ” (page 127).</p> <p>Off : Turn “MultEQ® XT 32” equalizer off.</p> <p></p> <ul style="list-style-type: none"> • “Audyssey”, “Audyssey Byp. L/R” and “Audyssey Flat” can be selected after Audyssey® Setup has been performed. “Audyssey” is automatically selected after performing Audyssey® Setup. When “Audyssey”, “Audyssey Byp. L/R” or “Audyssey Flat” is selected, AUDYSSEY illuminates. • After running Audyssey® Setup, if the Speaker Configuration, Distance, Channel Level, and Crossover Frequency have changed without increasing the number of speakers measured, only AUDYSSEY illuminates. <p>NOTE</p> <p>When using headphones, “MultEQ® XT 32” is automatically set to “Off”.</p>



“MultEQ® XT 32”, “Dynamic EQ” and “Dynamic Volume” settings are stored for each input source.

Setting items	Setting details
Dynamic EQ Solve the problem of deteriorating sound quality as volume is decreased by taking into account human perception and room acoustics. Works with MultEQ® XT 32.	<p>On : Use Dynamic EQ.</p> <p>Off : Do not use Dynamic EQ.</p> <p> AUDYSSEY is displayed when set to “On”.</p> <p>NOTE</p> <p>When the menu “Dynamic EQ” setting is “On”, it is not possible to do “Tone Control” (page 123) adjustment.</p>
Reference Level Offset Audyssey Dynamic EQ® is referenced to the standard film mix level. It makes adjustments to maintain the reference response and surround envelopment when the volume is turned down from 0 dB. However, film reference level is not always used in music or other non-film content. Dynamic EQ Reference Level Offset provides three offsets from the film level reference (5 dB, 10 dB, and 15 dB) that can be selected when the mix level of the content is not within the standard. Recommended setting levels are shown at right.	<p>0dB (Film Ref) : This is the default setting and should be used when listening to movies.</p> <p>5dB : Select this setting for content that has a very wide dynamic range, such as classical music.</p> <p>10dB : Select this setting for jazz or other music that has a wider dynamic range. This setting should also be selected for TV content as that is usually mixed at 10 dB below film reference.</p> <p>15dB : Select this setting for pop/rock music or other program material that is mixed at very high listening levels and has a compressed dynamic range.</p> <p> Setting is enabled when “Dynamic EQ” is “On” (page 125).</p>

Setting items	Setting details
<p>Dynamic Volume Solve the problem of large variations in volume level between TV, movies and other content (between quiet passages and loud passages, etc.) by automatically adjusting to the user's preferred volume setting.</p>	<p>Heavy : Most adjustment to softest and loudest sounds. Medium : Medium adjustment to loudest and softest sound. Light : Least adjustment to loudest and softest sounds. Off : Do not use "Dynamic Volume".</p> <p></p> <ul style="list-style-type: none"> • AUDYSSEY is displayed when set to "Heavy", "Medium" or "Light". • If "Dynamic Volume" is set to "Yes" in "Audyssey® Setup" (page 37), the setting is automatically changed to "Medium".
<p>Audyssey LFC™ Adjusts the low frequency band to prevent bass and vibration from being conveyed to neighboring rooms.</p>	<p>On : Use "Audyssey LFC™". Off : Do not use "Audyssey LFC™".</p> <p> "Audyssey LFC™" cannot be set up if "Audyssey® Setup" is not completed.</p> <div style="border: 1px solid black; padding: 5px; margin-top: 10px;"> <p align="center">About Audyssey LFC™ (Low Frequency Containment)</p> <p>Audyssey LFC™ solves the problem of low frequency sounds disturbing people in neighboring rooms or apartments. Audyssey LFC™ dynamically monitors the audio content and removes the low frequencies that pass through walls, floors and ceilings. It then applies psychoacoustic processing to restore the perception of low bass for listeners in the room. The result is great sound that no longer disturbs the neighbors.</p> </div>
<p>Containment Amount Adjusts the amount of low frequency containment. Use higher settings if you have close neighbors.</p>	<p>1 – 7 (4)</p>
<p>Audyssey DSX® Provides more immersive surround sound by adding the new channels.</p>	<p>Wides/Heights : Turns on Audyssey DSX® processing for wide and height expansion. Wides : Turn on Audyssey DSX® processing for wide expansion. Heights : Turn on Audyssey DSX® processing for height expansion. Off : Do not set Audyssey DSX®.</p> <p>NOTE</p> <p>"Audyssey DSX®" cannot be configured if the HD Audio source being played includes Front height and Front wide channels. In this case, the respective channels are played back using the input signals.</p>



Setting items	Setting details
<p>Stage Width Adjust sound stage width when using front wide speakers.</p>	<p>-10 – +10 (0)</p>
<p>Stage Height Adjust sound stage height when using front height speakers.</p>	<p>-10 – +10 (0)</p> <p></p> <ul style="list-style-type: none"> • "Audyssey DSX®" can be set when you are using front height speakers or front wide speakers. • "Audyssey DSX®" is only valid when using a center speaker. • "Audyssey DSX®" is valid when surround mode is DOLBY listening mode or DTS listening mode other than PLIIz Height. <div style="border: 1px solid black; padding: 5px; margin-top: 10px;"> <p align="center">About Audyssey Dynamic Surround Expansion (A-DSX)</p> <p>Audyssey DSX® is a scalable system that adds new speakers to improve surround impression. Starting with a 5.1 system Audyssey DSX® first adds Wide channels for the biggest impact on envelopment. Research in human hearing has proven that information from the Wide channels is much more critical in the presentation of a realistic soundstage than the Back Surround channels found in traditional 7.1 systems. Audyssey DSX® then creates a pair of Height channels to reproduce the next most important acoustical and perceptual cues. In addition to these new Wide and Height channels, Audyssey DSX® applies Surround Envelopment Processing to enhance the blend between the front and surround channels.</p> </div>

Graphic EQ

Default settings are underlined.

Use the graphic equalizer to adjust the tone of each speaker.

“Graphic EQ” can be set when “MultEQ® XT 32” setting (page 125) is “Graphic EQ”.

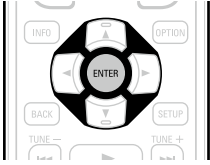
Setting items	Setting details
Speaker Selection Select whether to adjust tones for individual speakers or for all speakers.	All : Adjust the tone of all speakers together. Left/Right : Adjust the tone of left and right speakers together. Each : Adjust the tone of each speaker.
Adjust EQ Adjust tones for each frequency band. Adjust the speaker selected in “Speaker Selection”.	① Select the speaker. ② Select the adjustment frequency band. 63Hz / 125Hz / 250Hz / 500Hz / 1kHz / 2kHz / 4kHz / 8kHz / 16kHz • Select the speakers you want to adjust when “Left/Right” or “Each” is selected. ③ Adjust the level. -20.0dB – +6.0dB (0.0dB)
Curve Copy Copy “Audyssey Flat” (page 125) curve from MultEQ® XT 32.	Yes : Copy. No : Do not copy.  <ul style="list-style-type: none"> • “Curve Copy” is displayed after Audyssey® Setup has been performed. • When you select “Curve Copy” and press ENTER, the “Copy “Audyssey Flat?”” prompt is displayed. Select either “Yes” or “No”, and press ENTER.
Set Defaults The “Graphic EQ” settings are returned to the default settings.	Reset : Reset to the defaults. Cancel : Do not reset to the defaults.  When you select “Set Defaults” and press ENTER , the “Reset to the default values?” prompt is displayed. Select either “Reset” or “Cancel”, and press ENTER . 



Make video-related settings.

NOTE

When HDMI ZONE4 function is used, these settings are not available (except for “HDMI Control” and “Control Monitor”).

Menu operation

1 Press **ZONE SELECT** to switch the zone mode.

The **M** indicator lights.

2 Press **SETUP**.

The menu is displayed on the TV screen.

3 Use Δ / ∇ to select the menu to be set or operated.

4 Press **ENTER** or \triangleright to enter the setting.

- To return to the previous item, press \triangleleft or **BACK**.
- Exiting the Menu, press **SETUP** while the menu is displayed. The menu display disappears.

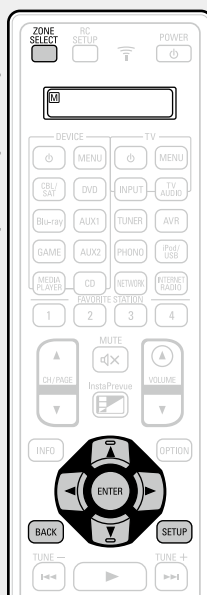

Items that can be set with the “Video” procedure

Picture Adjust ([page 129](#))

HDMI Setup ([page 129](#))

Output Settings ([page 131](#))

Analog Video Out ([page 132](#))

On Screen Display ([page 133](#))

TV Format ([page 133](#))





Picture Adjust



Default settings are underlined.

Picture quality can be adjusted.

We recommend leaving the settings unchanged from the default settings. First adjust the display image quality on your TV, and use this menu only when you want to make fine adjustments.

- This item can be set when the input source is **CBL/SAT** **DVD** **Blu-ray** **GAME** **AUX1** **AUX2** **MEDIA PLAYER** **iPod/USB** **NETWORK**.
- With input sources other than the ones above, this item can be set when "Video Select" is selected. In this case, the original input source settings are called out.
- Can be set when the "Video Conversion" setting ([page 131](#)) is "On".
- "TV AUDIO" or "CD" can be set when "HDMI", "COMP" or "VIDEO" ([page 135](#), [136](#)) has been assigned.

Setting items	Setting details
Picture Mode Select the desired picture mode according to the video signals and your viewing environment.	Standard : The standard mode suited for most living room viewing environments. Movie : A mode suited for watching movies in a dark room such as a theater room. Vivid : A mode that makes graphic images for games, etc. brighter and more vivid. Streaming : A mode suited for low bit rate video sources. Custom : Adjusts the picture quality manually. Off : No picture quality adjustment is done with this unit.  <ul style="list-style-type: none"> • You can also press OPTION to make these settings from "Picture Mode" (page 80) in the option menu. • The default settings are as follows. <ul style="list-style-type: none"> • For "Network" and "iPod/USB" input sources : Streaming • For input sources other than "Network" and "iPod/USB" : Off
Contrast Adjust picture contrast.	-6 - +6 (0)  "Contrast" can be set when "Picture mode" is set to "Custom".
Brightness Adjust picture brightness.	0 - +12  "Brightness" can be set when "Picture mode" is set to "Custom".
Saturation Adjust picture chroma level (saturation).	-6 - +6 (0)  "Saturation" can be set when "Picture mode" is set to "Custom".
Hue Adjust green and red balance.	-6 - +6 (0)  "Hue" can be set when "Picture mode" is set to "Custom".

Setting items	Setting details
Noise Reduction Reduce overall video noise.	Low / Medium / High / Off  "Noise Reduction" can be set when "Picture mode" is set to "Custom".
Enhancer Emphasize picture contours.	0 - +12  "Enhancer" can be set when "Picture mode" is set to "Custom".





- "Picture Adjust" can not be set when 4K signals are input.
- When TVs are simultaneously connected to HDMI MONITOR OUT 1, HDMI MONITOR OUT 2, COMPONENT VIDEO OUT and VIDEO MONITOR OUT connector for inputting video or component video signals, the "Picture Mode" - "Streaming", "Noise Reduction" and "Enhancer" settings are only valid for the TV that is connected via HDMI.



HDMI Setup

Default settings are underlined.

Make settings for HDMI video/audio output.

Setting items	Setting details
Auto Lip Sync Make automatic compensation for timing shift in audio and video output.	On : Compensated. Off : Not compensated.
HDMI Audio Out Select HDMI audio output device.	AVR : Play back through speakers connected to the unit. TV : Play back through TV connected to the unit.  <ul style="list-style-type: none"> • The audio signal input from the HDMI input connector can be output as an output signal from the HDMI output connector by setting the HDMI audio output destination to TV. Audio signals input via the Analog/Coaxial/Optical/EXTERNAL.IN input connectors cannot be output from the HDMI output connector. • When the HDMI control function is activated, priority is given to the TV audio setting (page 102 "HDMI control function").

Setting items	Setting details
Video Output Make settings for HDMI monitor output.	<p>Auto(Dual) : The presence of a TV connected to the HDMI MONITOR 1 or HDMI MONITOR 2 connector is detected automatically, and that TV connection is used.</p> <p>Monitor 1 : A TV connected to the HDMI MONITOR 1 connector is always used. Video is not output from the TV connected to the HDMI MONITOR 2 connector.</p> <p>Monitor 2 : A TV connected to the HDMI MONITOR 2 connector is always used. Video is not output from the TV connected to the HDMI MONITOR 1 connector.</p> <p></p> <ul style="list-style-type: none"> • If both the HDMI MONITOR 1 and HDMI MONITOR 2 connectors are connected and "Resolution" (page 132) is set to "Auto", the signals are output with a resolution compatible with both TV. • With "Resolution" (page 132) not set to "Auto", check whether the TV you are using is compatible with the resolution under "Video" – "HDMI Monitor 1" or "HDMI Monitor 2" (page 153). <p>NOTE</p> <p>Depending on the monitor you have connected, the display may not be correct when you set to "Auto(Dual)". In such a case, set to either "Monitor 1" or "Monitor 2".</p>
Vertical Stretch Sets whether video signals are vertically stretched or not.	<p>On : Stretches video signals vertically.</p> <p>Off : Does not stretch video signals vertically.</p> <p> "Vertical Stretch" can be set when "i/p Scaler" is set to anything other than "Off".</p>
HDMI Pass Through Selects how the AVR will pass HDMI signals to the HDMI output in standby power mode.	<p>On : Passes the selected HDMI input through the AV receiver's HDMI output when the AV receiver is in standby power mode.</p> <p>Off : No HDMI signals are passed through the AV receiver's HDMI output in standby power mode.</p> <p>NOTE</p> <p>When "HDMI Pass Through" is set to "On", it consumes more standby power. If you are not using this unit for an extended period, it is recommended that you unplug the power cord from the power outlet.</p>

Setting items	Setting details
HDMI Control You can link operations with devices connected to HDMI and compatible with HDMI Control.	<p>On : Use HDMI control function.</p> <p>Off : Do not use HDMI control function.</p> <p></p> <ul style="list-style-type: none"> • When a device that is not compatible with the HDMI control function is connected, set "HDMI Control" to "Off". • Please consult the operating instructions for each connected device to check the settings. • Refer to "HDMI control function" (page 102) for more information about the HDMI control function. <p>NOTE</p> <ul style="list-style-type: none"> • When "HDMI Control" is set to "On", it consumes more standby power. If you are not using this unit for an extended period, it is recommended that you unplug the power cord from the power outlet. • The HDMI control function controls operations of a TV that is compatible with the HDMI control function. Make sure that the TV and HDMI are connected when you perform HDMI control. • If the "HDMI Control" settings have been changed, always reset the power to connected devices after the change.
Pass Through Source The AVR will "pass through" the sources HDMI video signal when in standby.	<p>Last : Choose this option to "pass through" the last used HDMI input video source.</p> <p>CBL/SAT / DVD / Blu-ray / GAME / AUX1 / AUX2 / MEDIA PLAYER / CD / TV AUDIO : Choose one of these HDMI sources to be passed through when the AVR is in standby.</p> <p> "Pass Through Source" can be set when "HDMI Control" is set to "On" or "HDMI Pass Through" is set to "On".</p>
Control Monitor Selects the HDMI monitor for which you want to enable the HDMI control function.	<p>Monitor 1 : Uses the HDMI Monitor 1 for HDMI control.</p> <p>Monitor 2 : Uses the HDMI Monitor 2 for HDMI control.</p> <p>ZONE4 : Uses the HDMI monitor in ZONE4 for HDMI control.</p> <p></p> <ul style="list-style-type: none"> • "Control Monitor" can be set when "HDMI Control" is set to "On". • The ARC function only works for either the HDMI Monitor 1 or HDMI Monitor 2 connector that is specified in "Control Monitor".

Setting items	Setting details
<p>Power Off Control Links the power standby of this unit to external devices.</p>	<p>All : If power to a connected TV is turned off independently of the input source, power to this unit is automatically set to standby. Video : When the TV is turned off with one of "HDMI", "COMP" or "VIDEO" (refer page 135, 136) assigned for the CBL/SAT / DVD / Blu-ray / GAME / AUX1 / AUX2 / MEDIA PLAYER / CD / TV AUDIO input source on this unit, power to this unit is automatically set to standby. Off : This unit does not link with power to a TV.</p> <p> "Power Off Control" can be set when "HDMI Control" is set to "On".</p> <p>NOTE "Power Off Control" cannot be set when "Control Monitor" is set to "ZONE4".</p>

Output Settings

Default settings are underlined.

Makes screen-related settings.

* "CBL/SAT", "DVD", "Blu-ray", "GAME", "AUX1", "AUX2", "MEDIA PLAYER", "CD" or "TV AUDIO" can be set when "HDMI", "COMP" or "VIDEO" (refer page 135, 136) has been assigned.





"Output Settings" can not be set when 4K signals are input.

Setting items	Setting details										
<p>Video Mode Make settings for video processing.</p> <table border="1"> <tr> <td>CBL/SAT *</td> <td>DVD *</td> </tr> <tr> <td>Blu-ray *</td> <td>GAME *</td> </tr> <tr> <td>AUX1 *</td> <td>AUX2 *</td> </tr> <tr> <td colspan="2">MEDIA PLAYER *</td> </tr> <tr> <td>CD *</td> <td>TV AUDIO *</td> </tr> </table>	CBL/SAT *	DVD *	Blu-ray *	GAME *	AUX1 *	AUX2 *	MEDIA PLAYER *		CD *	TV AUDIO *	<p>Auto : Process video automatically based on the HDMI content information. Game : Always process video for game content. Movie : Always process video for movie content.</p> <p> "Video Mode" is set to "Auto", the mode is switched according to the input contents.</p> <p>• If a source is played in both MAIN ZONE (audio and video) and ZONE2 (audio only) modes in the same room, audio in MAIN ZONE and ZONE2 modes may sound out of synchronization, but this is not malfunction. In this case, setting to "Game" mode may improve audio synchronization.</p>
CBL/SAT *	DVD *										
Blu-ray *	GAME *										
AUX1 *	AUX2 *										
MEDIA PLAYER *											
CD *	TV AUDIO *										

Setting items	Setting details										
<p>Video Conversion The input video signal is converted automatically in conjunction with the connected TV (refer page 7 "Converting input video signals for output (Video conversion function)").</p> <table border="1"> <tr> <td>CBL/SAT *</td> <td>DVD *</td> </tr> <tr> <td>Blu-ray *</td> <td>GAME *</td> </tr> <tr> <td>AUX1 *</td> <td>AUX2 *</td> </tr> <tr> <td colspan="2">MEDIA PLAYER *</td> </tr> <tr> <td>CD *</td> <td>TV AUDIO *</td> </tr> </table>	CBL/SAT *	DVD *	Blu-ray *	GAME *	AUX1 *	AUX2 *	MEDIA PLAYER *		CD *	TV AUDIO *	<p>On : The input video signal is converted. Off : The input video signal is not converted.</p> <p></p> <ul style="list-style-type: none"> • When a non-standard video signal from a game machine or some other source is input, the video conversion function might not operate. In this case set "Video Conversion" to "Off". • When "Video Conversion" is set to "Off", the video conversion function does not work. In this case, connect this unit and TV with the same type of cable.
CBL/SAT *	DVD *										
Blu-ray *	GAME *										
AUX1 *	AUX2 *										
MEDIA PLAYER *											
CD *	TV AUDIO *										

<p>i/p Scaler Convert the input source resolution to the resolution set.</p> <table border="1"> <tr> <td>CBL/SAT *</td> <td>DVD *</td> </tr> <tr> <td>Blu-ray *</td> <td>GAME *</td> </tr> <tr> <td>AUX1 *</td> <td>AUX2 *</td> </tr> <tr> <td colspan="2">MEDIA PLAYER *</td> </tr> <tr> <td>iPod/USB *</td> <td>CD *</td> </tr> <tr> <td>NETWORK *</td> <td>TV AUDIO *</td> </tr> </table>	CBL/SAT *	DVD *	Blu-ray *	GAME *	AUX1 *	AUX2 *	MEDIA PLAYER *		iPod/USB *	CD *	NETWORK *	TV AUDIO *	<p>Analog : Use i/p scaler function for analog video signal. Analog & HDMI : Use i/p scaler function for analog and HDMI video signal. HDMI : Use i/p scaler function for HDMI video signal. Off : Do not use i/p scaler function.</p> <p></p> <ul style="list-style-type: none"> • "Analog & HDMI" can be set for input sources for which an HDMI input connector is assigned. • Which items can be set depend on the input source assigned to each input connector. • This function is not effective when the input signal is "x.v.Color", 3D, sYCC 601 color, Adobe RGB color, Adobe YCC 601 color or computer resolution.
CBL/SAT *	DVD *												
Blu-ray *	GAME *												
AUX1 *	AUX2 *												
MEDIA PLAYER *													
iPod/USB *	CD *												
NETWORK *	TV AUDIO *												

Setting items	Setting details																								
<p>Resolution Set the output resolution. You can set "Resolution" separately for HDMI output of the analog video input and HDMI input.</p> <table border="1"> <tr><td>CBL/SAT</td><td>*</td><td>DVD</td><td>*</td></tr> <tr><td>Blu-ray</td><td>*</td><td>GAME</td><td>*</td></tr> <tr><td>AUX1</td><td>*</td><td>AUX2</td><td>*</td></tr> <tr><td colspan="4">MEDIA PLAYER</td></tr> <tr><td>iPod/USB</td><td></td><td>CD</td><td>*</td></tr> <tr><td>NETWORK</td><td></td><td>TV AUDIO</td><td>*</td></tr> </table>	CBL/SAT	*	DVD	*	Blu-ray	*	GAME	*	AUX1	*	AUX2	*	MEDIA PLAYER				iPod/USB		CD	*	NETWORK		TV AUDIO	*	<p>Auto : The number of pixels the TV connected to the HDMI MONITOR OUT connector supports is detected automatically and the appropriate output resolution is set. 480p/576p / 1080i / 720p / 1080p / 1080p:24Hz / 4K : Set the output resolution.</p> <p> This item can be set when "i/p Scaler" is set to anything other than "Off".</p> <ul style="list-style-type: none"> When "i/p Scaler" is set to "Analog & HDMI", the resolution of both the analog video input signal and HDMI input signal can be set. To watch 1080p/24Hz pictures, use a TV that supports 1080p/24Hz video signals. When set to "1080p:24Hz", you can enjoy film-like pictures for film sources (in 24 Hz). For video sources and mixed sources, we recommend setting the resolution to "1080p". It is not possible to convert a 50 Hz signal into 1080p/24Hz. It is output at a resolution of 1080p/50Hz.
CBL/SAT	*	DVD	*																						
Blu-ray	*	GAME	*																						
AUX1	*	AUX2	*																						
MEDIA PLAYER																									
iPod/USB		CD	*																						
NETWORK		TV AUDIO	*																						
<p>Progressive Mode Set an appropriate progressive conversion mode for the source video signal.</p> <table border="1"> <tr><td>CBL/SAT</td><td>*</td><td>DVD</td><td>*</td></tr> <tr><td>Blu-ray</td><td>*</td><td>GAME</td><td>*</td></tr> <tr><td>AUX1</td><td>*</td><td>AUX2</td><td>*</td></tr> <tr><td colspan="4">MEDIA PLAYER</td></tr> <tr><td>CD</td><td>*</td><td>TV AUDIO</td><td>*</td></tr> </table>	CBL/SAT	*	DVD	*	Blu-ray	*	GAME	*	AUX1	*	AUX2	*	MEDIA PLAYER				CD	*	TV AUDIO	*	<p>Auto : The video signal is automatically detected and the appropriate mode is set. Video : Select mode suitable for video playback. Video and Film : Select mode suitable for video and 30-frame film material playback.</p> <p> This item can be set when "i/p Scaler" is set to anything other than "Off".</p>				
CBL/SAT	*	DVD	*																						
Blu-ray	*	GAME	*																						
AUX1	*	AUX2	*																						
MEDIA PLAYER																									
CD	*	TV AUDIO	*																						

Setting items	Setting details																								
<p>Aspect Ratio Set the aspect ratio for the video signals output to the HDMI.</p> <table border="1"> <tr><td>CBL/SAT</td><td>*</td><td>DVD</td><td>*</td></tr> <tr><td>Blu-ray</td><td>*</td><td>GAME</td><td>*</td></tr> <tr><td>AUX1</td><td>*</td><td>AUX2</td><td>*</td></tr> <tr><td colspan="4">MEDIA PLAYER</td></tr> <tr><td>iPod/USB</td><td></td><td>CD</td><td>*</td></tr> <tr><td>NETWORK</td><td></td><td>TV AUDIO</td><td>*</td></tr> </table>	CBL/SAT	*	DVD	*	Blu-ray	*	GAME	*	AUX1	*	AUX2	*	MEDIA PLAYER				iPod/USB		CD	*	NETWORK		TV AUDIO	*	<p>16:9 : Output at 16:9 aspect ratio. 4:3 : Output at 4:3 aspect ratio with black bars on the sides of a 16:9 TV screen (except for 480p/576p output).</p> <p> "Aspect Ratio" can be set when "i/p Scaler" is set to anything other than "Off".</p>
CBL/SAT	*	DVD	*																						
Blu-ray	*	GAME	*																						
AUX1	*	AUX2	*																						
MEDIA PLAYER																									
iPod/USB		CD	*																						
NETWORK		TV AUDIO	*																						
<p>* "CBL/SAT", "DVD", "Blu-ray", "GAME", "AUX1", "AUX2", "MEDIA PLAYER", "CD" or "TV AUDIO" can be set when "HDMI", "COMP" or "VIDEO" (page 135, 136) has been assigned.</p>																									

Analog Video Out

Default settings are underlined.

Assigns the zone that uses the COMPONENT VIDEO MONITOR OUT and the VIDEO MONITOR OUT connectors.

Setting items	Setting details
ZONE	<p>MAIN ZONE : Uses the COMPONENT VIDEO MONITOR OUT and the VIDEO MONITOR OUT connectors for MAIN ZONE. ZONE3 : Uses the COMPONENT VIDEO MONITOR OUT and the VIDEO MONITOR OUT connectors for ZONE3.</p>

On Screen Display

Default settings are underlined.

Select the on-screen display user interface preferences.

Setting items	Setting details
Volume Sets where to display the master volume level.	<u>Bottom</u> : Display at the bottom. <u>Top</u> : Display at the top. <u>Off</u> : Turn display off.  When the master volume display is hard to see when superimposed on movie subtitles, set to "Top".
Info Displays status of operation temporarily when the sound mode is changed, or input source is switched. You can set whether or not to show each of these status displays.	<u>On</u> : Turn display on. <u>Off</u> : Turn display off.
Now Playing Sets how long each menu is displayed when the input source is "NETWORK", "iPod/USB", or "HD Radio".	<u>Always On</u> : Show display continuously. <u>Auto Off</u> : Show display for 30 seconds after operation.

TV Format

Default settings are underlined.

Set the video signal format to be output for the TV you are using.

Setting items	Setting details
Format	<u>NTSC</u> : Select NTSC output. <u>PAL</u> : Select PAL output.  "Format" can also be set by the following procedure. However, the menu screen is not displayed. <ol style="list-style-type: none"> 1. Press and hold the main unit's < > for at least 3 seconds. "*Video Format < NTSC >" appears on the display. 2. Use the main unit's < > and set the video signal format. 3. Press the main unit's ENTER to complete the setting. <div style="background-color: #f08080; border-radius: 10px; padding: 2px 5px; display: inline-block; margin-top: 10px;">NOTE</div> <p>When a format other than the video format of the connected TV is set, the picture will not be displayed properly.</p>



Perform settings related to input source playback.

- You do not have to change the settings to use the unit. Make settings when needed.

Menu operation

1 Press **ZONE SELECT** to switch the zone mode.

The **M** indicator lights.

2 Press **SETUP**.

The menu is displayed on the TV screen.

3 Use Δ / ∇ to select the menu to be set or operated.

4 Press **ENTER** or \triangleright to enter the setting.

- To return to the previous item, press \triangleleft or **BACK**.
- Exiting the Menu, press **SETUP** while the menu is displayed. The menu display disappears.



Items that can be set with the “Inputs” procedure

Input Assign ([page 135](#))

Source Rename ([page 137](#))

Hide Sources ([page 137](#))

Source Level ([page 137](#))

Input Select ([page 138](#))

Video Source ([page 138](#))

Important information

□ About the display of input sources

In this section, the configurable input sources for each item are shown as follows.

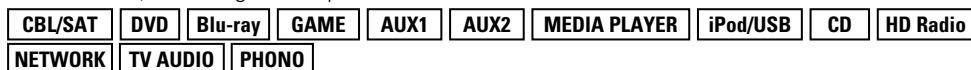

NOTE

Input sources that have been set to “Hide” at “Hide Sources” ([page 137](#)) cannot be selected.

Input Assign

This unit has certain input sources such as “CBL/SAT” assigned to audio and video connectors by default. By making the default connections, you can simply press an input source select button to play back audio or video from the connected device with ease.

When making connections other than the default settings, you must change settings in this section.

Examples of “Input Assign” menu screen displays

This screen appears when the “Inputs” – “each input source” – “Input Assign” menu is selected. Use the “Input Assign” menu to change the ② HDMI input connectors, ③ Digital input connectors, ④ Analog input connectors, ⑤ Component input connectors, and ⑥ Video input connectors that are assigned to the ① input sources in default settings.

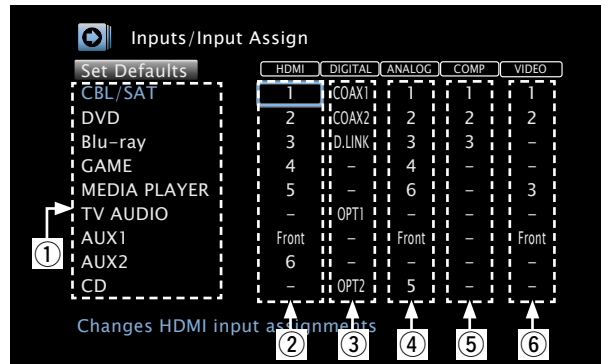

Input assignments menu operations

1 Use Δ ∇ \triangleleft \triangleright to move the cursor to the item you want to set, and then press **ENTER**.

2 Use \triangleleft \triangleright to select the input connector to be assigned.

3 Press **ENTER** to register the setting.

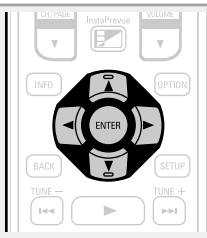

Setting items	Setting details																
HDMI Set this to change the HDMI input connectors assigned to the input sources.	1 / 2 / 3 / 4 / 5 / 6 / Front : Assign an HDMI input connector to the selected input source. - : Do not assign an HDMI input connector to the selected input source.																
CBL/SAT DVD	• At time of purchase, the settings of the different input sources are as shown below.																
Blu-ray GAME	<table border="1"> <thead> <tr> <th>Input source</th> <th>CBL/SAT</th> <th>DVD</th> <th>Blu-ray</th> <th>GAME</th> <th>AUX1</th> </tr> </thead> <tbody> <tr> <td>Default setting</td> <td>1</td> <td>2</td> <td>3</td> <td>4</td> <td>Front</td> </tr> </tbody> </table>					Input source	CBL/SAT	DVD	Blu-ray	GAME	AUX1	Default setting	1	2	3	4	Front
Input source	CBL/SAT	DVD	Blu-ray	GAME	AUX1												
Default setting	1	2	3	4	Front												
AUX1 AUX2	<table border="1"> <thead> <tr> <th>Input source</th> <th>AUX2</th> <th>MEDIA PLAYER</th> <th>CD</th> <th>TV AUDIO</th> </tr> </thead> <tbody> <tr> <td>Default setting</td> <td>6</td> <td>5</td> <td>-</td> <td>-</td> </tr> </tbody> </table>					Input source	AUX2	MEDIA PLAYER	CD	TV AUDIO	Default setting	6	5	-	-		
Input source	AUX2	MEDIA PLAYER	CD	TV AUDIO													
Default setting	6	5	-	-													
MEDIA PLAYER CD	<ul style="list-style-type: none"> To play the video signal assigned at “HDMI” combined with the audio signal assigned at “Input Assign” – “DIGITAL”, select “Digital” at “Input Mode” (page 138). Audio signals input from analog and digital connectors cannot be output to a TV that is connected via HDMI. When “HDMI Control” (page 130) is set to “On”, HDMI input connector cannot be assigned to “TV AUDIO”. 																
TV AUDIO																	

Setting items	Setting details																																
DIGITAL Set this to change the digital input connectors assigned to the input sources. <table border="1" data-bbox="114 288 331 456"> <tr><td>CBL/SAT</td><td>DVD</td></tr> <tr><td>Blu-ray</td><td>GAME</td></tr> <tr><td>AUX1</td><td>AUX2</td></tr> <tr><td>MEDIA PLAYER</td><td>CD</td></tr> <tr><td>TV AUDIO</td><td></td></tr> </table>	CBL/SAT	DVD	Blu-ray	GAME	AUX1	AUX2	MEDIA PLAYER	CD	TV AUDIO		COAX 1 / COAX 2 / OPT 1 / OPT 2 : Assign a digital input connector to the selected input source. D.LINK : Assign the Denon Link HD connector when the Denon Link HD connection is established to a player compatible with the Denon Link HD function (page 13). – : Do not assign a digital input connector to the selected input source. <ul style="list-style-type: none"> At time of purchase, the settings of the different input sources are as shown below. <table border="1" data-bbox="416 395 1093 531"> <thead> <tr> <th>Input source</th> <th>CBL/SAT</th> <th>DVD</th> <th>Blu-ray</th> <th>GAME</th> <th>AUX1</th> </tr> </thead> <tbody> <tr> <td>Default setting</td> <td>COAX 1</td> <td>COAX 2</td> <td>D.LINK</td> <td>–</td> <td>–</td> </tr> </tbody> </table> <table border="1" data-bbox="416 544 1093 679"> <thead> <tr> <th>Input source</th> <th>AUX2</th> <th>MEDIA PLAYER</th> <th>CD</th> <th>TV AUDIO</th> </tr> </thead> <tbody> <tr> <td>Default setting</td> <td>–</td> <td>–</td> <td>OPT 2</td> <td>OPT 1</td> </tr> </tbody> </table>	Input source	CBL/SAT	DVD	Blu-ray	GAME	AUX1	Default setting	COAX 1	COAX 2	D.LINK	–	–	Input source	AUX2	MEDIA PLAYER	CD	TV AUDIO	Default setting	–	–	OPT 2	OPT 1
CBL/SAT	DVD																																
Blu-ray	GAME																																
AUX1	AUX2																																
MEDIA PLAYER	CD																																
TV AUDIO																																	
Input source	CBL/SAT	DVD	Blu-ray	GAME	AUX1																												
Default setting	COAX 1	COAX 2	D.LINK	–	–																												
Input source	AUX2	MEDIA PLAYER	CD	TV AUDIO																													
Default setting	–	–	OPT 2	OPT 1																													
ANALOG Set this to change the analog audio input connectors assigned to the input sources. <table border="1" data-bbox="114 839 331 1007"> <tr><td>CBL/SAT</td><td>DVD</td></tr> <tr><td>Blu-ray</td><td>GAME</td></tr> <tr><td>AUX1</td><td>AUX2</td></tr> <tr><td>MEDIA PLAYER</td><td>CD</td></tr> <tr><td>TV AUDIO</td><td></td></tr> </table>	CBL/SAT	DVD	Blu-ray	GAME	AUX1	AUX2	MEDIA PLAYER	CD	TV AUDIO		1 / 2 / 3 / 4 / 5 / 6 / Front : Assign a analog input connector to the selected input source. – : Do not assign a analog input connector to the selected input source. <ul style="list-style-type: none"> At time of purchase, the settings of the different input sources are as shown below. <table border="1" data-bbox="416 839 1093 975"> <thead> <tr> <th>Input source</th> <th>CBL/SAT</th> <th>DVD</th> <th>Blu-ray</th> <th>GAME</th> <th>AUX1</th> </tr> </thead> <tbody> <tr> <td>Default setting</td> <td>1</td> <td>2</td> <td>3</td> <td>4</td> <td>Front</td> </tr> </tbody> </table> <table border="1" data-bbox="416 987 1093 1123"> <thead> <tr> <th>Input source</th> <th>AUX2</th> <th>MEDIA PLAYER</th> <th>CD</th> <th>TV AUDIO</th> </tr> </thead> <tbody> <tr> <td>Default setting</td> <td>–</td> <td>6</td> <td>5</td> <td>–</td> </tr> </tbody> </table>	Input source	CBL/SAT	DVD	Blu-ray	GAME	AUX1	Default setting	1	2	3	4	Front	Input source	AUX2	MEDIA PLAYER	CD	TV AUDIO	Default setting	–	6	5	–
CBL/SAT	DVD																																
Blu-ray	GAME																																
AUX1	AUX2																																
MEDIA PLAYER	CD																																
TV AUDIO																																	
Input source	CBL/SAT	DVD	Blu-ray	GAME	AUX1																												
Default setting	1	2	3	4	Front																												
Input source	AUX2	MEDIA PLAYER	CD	TV AUDIO																													
Default setting	–	6	5	–																													

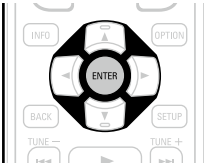
Setting items	Setting details																																
COMP (Component video) Set this to change the component video input connectors assigned to the input sources. <table border="1" data-bbox="1144 341 1361 509"> <tr><td>CBL/SAT</td><td>DVD</td></tr> <tr><td>Blu-ray</td><td>GAME</td></tr> <tr><td>AUX1</td><td>AUX2</td></tr> <tr><td>MEDIA PLAYER</td><td>CD</td></tr> <tr><td>TV AUDIO</td><td></td></tr> </table>	CBL/SAT	DVD	Blu-ray	GAME	AUX1	AUX2	MEDIA PLAYER	CD	TV AUDIO		1 / 2 / 3 : Assign the component video input connector to the selected input source. – : Do not assign a component video input connector to the selected input source. <ul style="list-style-type: none"> At time of purchase, the settings of the different input sources are as shown below. <table border="1" data-bbox="1447 341 2123 477"> <thead> <tr> <th>Input source</th> <th>CBL/SAT</th> <th>DVD</th> <th>Blu-ray</th> <th>GAME</th> <th>AUX1</th> </tr> </thead> <tbody> <tr> <td>Default setting</td> <td>1</td> <td>2</td> <td>3</td> <td>–</td> <td>–</td> </tr> </tbody> </table> <table border="1" data-bbox="1447 489 2123 625"> <thead> <tr> <th>Input source</th> <th>AUX2</th> <th>MEDIA PLAYER</th> <th>CD</th> <th>TV AUDIO</th> </tr> </thead> <tbody> <tr> <td>Default setting</td> <td>–</td> <td>–</td> <td>–</td> <td>–</td> </tr> </tbody> </table>	Input source	CBL/SAT	DVD	Blu-ray	GAME	AUX1	Default setting	1	2	3	–	–	Input source	AUX2	MEDIA PLAYER	CD	TV AUDIO	Default setting	–	–	–	–
CBL/SAT	DVD																																
Blu-ray	GAME																																
AUX1	AUX2																																
MEDIA PLAYER	CD																																
TV AUDIO																																	
Input source	CBL/SAT	DVD	Blu-ray	GAME	AUX1																												
Default setting	1	2	3	–	–																												
Input source	AUX2	MEDIA PLAYER	CD	TV AUDIO																													
Default setting	–	–	–	–																													
VIDEO Set this to change the composite video input connectors assigned to the input sources. <table border="1" data-bbox="1144 785 1361 952"> <tr><td>CBL/SAT</td><td>DVD</td></tr> <tr><td>Blu-ray</td><td>GAME</td></tr> <tr><td>AUX1</td><td>AUX2</td></tr> <tr><td>MEDIA PLAYER</td><td>CD</td></tr> <tr><td>TV AUDIO</td><td></td></tr> </table>	CBL/SAT	DVD	Blu-ray	GAME	AUX1	AUX2	MEDIA PLAYER	CD	TV AUDIO		1 / 2 / 3 / Front : Assign the video input connector to the selected input source. – : Do not assign a video input connector to the selected input source. <ul style="list-style-type: none"> At time of purchase, the settings of the different input sources are as shown below. <table border="1" data-bbox="1447 785 2123 920"> <thead> <tr> <th>Input source</th> <th>CBL/SAT</th> <th>DVD</th> <th>Blu-ray</th> <th>GAME</th> <th>AUX1</th> </tr> </thead> <tbody> <tr> <td>Default setting</td> <td>1</td> <td>2</td> <td>–</td> <td>–</td> <td>Front</td> </tr> </tbody> </table> <table border="1" data-bbox="1447 933 2123 1069"> <thead> <tr> <th>Input source</th> <th>AUX2</th> <th>MEDIA PLAYER</th> <th>CD</th> <th>TV AUDIO</th> </tr> </thead> <tbody> <tr> <td>Default setting</td> <td>–</td> <td>3</td> <td>–</td> <td>–</td> </tr> </tbody> </table>	Input source	CBL/SAT	DVD	Blu-ray	GAME	AUX1	Default setting	1	2	–	–	Front	Input source	AUX2	MEDIA PLAYER	CD	TV AUDIO	Default setting	–	3	–	–
CBL/SAT	DVD																																
Blu-ray	GAME																																
AUX1	AUX2																																
MEDIA PLAYER	CD																																
TV AUDIO																																	
Input source	CBL/SAT	DVD	Blu-ray	GAME	AUX1																												
Default setting	1	2	–	–	Front																												
Input source	AUX2	MEDIA PLAYER	CD	TV AUDIO																													
Default setting	–	3	–	–																													
Set Defaults The “Input Assign” settings are returned to the default settings.	Reset : Reset to the defaults. Cancel : Do not reset to the defaults. <ul style="list-style-type: none"> If you select “Set Defaults” and press ENTER, the message “Reset to the default values?” is displayed. Select “Reset” or “Cancel”, and then press ENTER. 																																

Source Rename

Change the display name of the selected input source.

This is convenient when the input source name of your device and the input source name of this unit are different. You can change the name to suit your needs. When the renaming is completed, the name is displayed on this unit's display and on the menu screen.

Setting details

CBL/SAT / DVD / Blu-ray / GAME / AUX1 / AUX2 / MEDIA PLAYER / CD / TV AUDIO / PHONO :

Change the display name of the selected input source.

- Up to 12 characters can be input.
- For character input, see [page 118](#).

Set Defaults : The "Source Rename" settings are returned to the default settings.

- **Reset :** Reset to the defaults.
- **Cancel :** Do not reset to the defaults.

- If you select "Set Defaults" and press **ENTER**, the message "Reset all source names to the factory defaults?" is displayed. Select "Reset" or "Cancel", and then press **ENTER**.

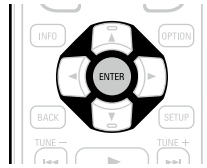

Hide Sources

Default settings are underlined.

Remove from the display input sources that are not used.

Setting details

CBL/SAT / DVD / Blu-ray / GAME / AUX1 / AUX2 / MEDIA PLAYER / iPod/USB / CD / HD Radio / Favorites / Internet Radio / Pandora / SiriusXM / Spotify / Flickr / TV AUDIO / PHONO : Select input source that is not used.

- **Show :** Use this source.
- **Hide :** Do not use this source.

NOTE

- Input sources being used in the various zones cannot be deleted.
- Input sources set to "Hide" cannot be selected using the input source select button.

Source Level

Default settings are underlined.



- This function corrects the playback level of the selected input source's audio input.
- Make this setting if there are differences in the input volume levels between the different sources.

Setting items	Setting details
Source Level iPod/USB HD Radio NETWORK	-12dB – +12dB (0dB)
Analog Inputs CBL/SAT DVD Blu-ray GAME AUX1 AUX2 MEDIA PLAYER CD TV AUDIO PHONO	-12dB – +12dB (0dB) The analog input level can be adjusted independently for input sources for which "ANALOG" is assigned at "Input Assign" (page 136).
Digital Inputs CBL/SAT DVD Blu-ray GAME AUX1 AUX2 MEDIA PLAYER CD TV AUDIO	-12dB – +12dB (0dB) The digital input level can be adjusted independently for input sources for which "DIGITAL" is assigned at "Input Assign" (page 136).

Input Select

Default settings are underlined.

Set the audio input mode and decode mode of each input source.
The input modes available for selection may vary depending on the input source.

Setting items	Setting details
Input Mode Set the audio input modes for the different input sources. It is normally recommended to set the audio input mode to "Auto".	<p>Auto : Automatically detect input signal and perform playback.</p> <p>HDMI : Play only signals from HDMI input.</p> <p>Digital : Play only signals from digital input.</p> <p>Analog : Play only signals from analog input.</p> <p>EXTERNAL IN : Play only signals from EXTERNAL IN input.</p> <p></p> <ul style="list-style-type: none"> • "Digital" can be set for input sources for which "DIGITAL" is assigned at "Input Assign" (page 136). • "AUX2" or "TV AUDIO" can be selected only when "Analog" is assigned to the input source. • When digital signals are properly input, the DIG indicator lights on the display. If the DIG indicator does not light, check "Input Assign" (page 136) and the connections. • If "HDMI Control" is set to "On" and a TV compatible with the ARC is connected via the HDMI MONITOR connectors, the input mode whose input source is "TV AUDIO" is fixed to ARC.
Decode Mode Set the audio decode mode for input source.	<p>Auto : Detect type of digital input signal and decode and play automatically.</p> <p>PCM : Decode and play only PCM input signals.</p> <p>DTS : Decode and play only DTS input signals.</p> <p></p> <ul style="list-style-type: none"> • This item can be set for input sources for which "DIGITAL" is assigned at "Input Assign" (page 136). • Normally set this mode to "Auto". Set "PCM" and "DTS" when inputting the corresponding input signal.

Video Source

Default settings are underlined.

Video of another input source is played back combined with the playing audio.

Setting items	Setting details
Video Select	<p>Default : Play the picture and sound of the input source.</p> <p>CBL/SAT / DVD / Blu-ray / GAME / AUX1 / AUX2 / MEDIA PLAYER / CD / TV AUDIO : Select video input source to view. The video of the selected input source is played along with the audio currently being played. This can be set for individual input sources.</p> <p> "CBL/SAT", "DVD", "Blu-ray", "GAME", "AUX1", "AUX2", "MEDIA PLAYER", "CD" or "TV AUDIO" can be selected only when "COMP" or "VIDEO" is assigned to the input source.</p> <p>NOTE</p> <ul style="list-style-type: none"> • It is not possible to select HDMI input signals. • Input sources for which "Hide" is selected at "Hide Sources" (page 137) cannot be selected.



Set when changing Audyssey® Setup settings.

- If you change the speaker settings after performing Audyssey® Setup, it will not be possible to set Audyssey MultEQ® XT 32, Audyssey Dynamic EQ® and Audyssey Dynamic Volume® (page 125, 126).
- Can be used without changing the settings. Please set if necessary.

Menu operation

1 Press **ZONE SELECT** to switch the zone mode.

The **M** indicator lights.

2 Press **SETUP**.

The menu is displayed on the TV screen.

3 Use Δ / ∇ to select the menu to be set or operated.

4 Press **ENTER** or \triangleright to enter the setting.

- To return to the previous item, press \triangleleft or **BACK**.
- Exiting the Menu, press **SETUP** while the menu is displayed. The menu display disappears.

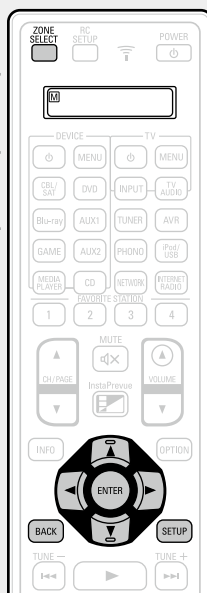

Items that can be set with the “Speakers” procedure

Audyssey® Setup (page 33, 99)

Manual Setup (page 141)

Steps for setting "Amp Assign"

This unit is provided with 12 types of Assign Mode settings.

You can switch the channels assigned to a power amplifier in accordance with your speaker system or perform playback using up to 11.1 channels using a combination of the built-in power amplifier and an external power amplifier. You can also use this unit as a preamplifier.

Use the following flowchart to set the speaker system of this unit.

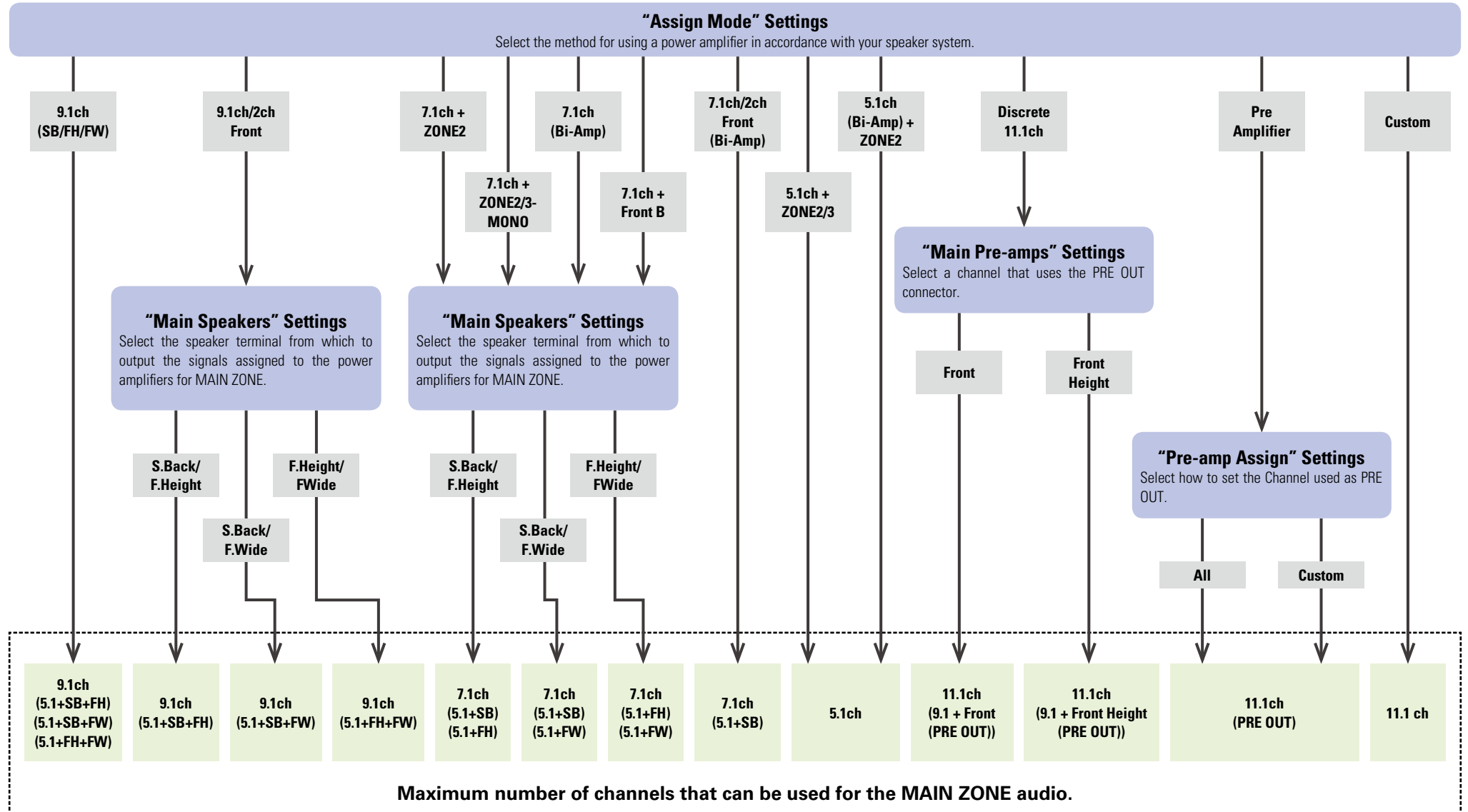

Manual Setup

Default settings are underlined.

Perform when setting the speakers manually or when changing settings made in Audyssey® Setup.





- If you change the speaker settings after performing Audyssey® Setup, it will not be possible to select Audyssey MultEQ® XT 32, Audyssey Dynamic EQ® and Audyssey Dynamic Volume® (page 125, 126).
- “Manual Setup” can be used without changing the settings. Please set if necessary.

Setting items	Setting details
Amp Assign Select power amplifier usage method to match your speaker system.	Assign Mode : Set the assignment mode. <ul style="list-style-type: none"> • 9.1ch(SB/FH/FW) : Assigns all power amplifiers within this unit for MAIN ZONE. • 7.1ch + ZONE2 : Assigns power amplifiers within this unit as follows: 7.1ch for MAIN ZONE and 2ch for ZONE2. • 5.1ch + ZONE2/3 : Assigns power amplifiers within this unit as follows: 5.1ch for MAIN ZONE and 2ch for ZONE2 and ZONE3 each. • 7.1ch + ZONE2/3-MONO : Assigns power amplifiers within this unit as follows: 7.1ch for MAIN ZONE and 1ch for ZONE2 and ZONE3 each. • 7.1ch(Bi-Amp) : Assigns power amplifiers within this unit as follows: 7.1ch for MAIN ZONE and 2ch for the front speaker bi-amplifier connection. • 5.1ch(Bi-Amp) + ZONE2 : Assigns power amplifiers within this unit as follows: 5.1ch for MAIN ZONE, 2ch for the front speaker bi-amplifier connection, and 2ch for ZONE2. • 9.1ch/2ch Front : Assigns all power amplifiers within this unit for MAIN ZONE. Up to 9.1ch playback is available. You can also use a front speaker that is different from the one used during multi-channel playback for playback by switching the internal power amplifier during 2ch playback. • 7.1ch/2ch Front(Bi-Amp) : Assigns power amplifiers within this unit as follows: 7.1ch for the MAIN ZONE multi-channel playback. You can also use a front speaker that is different from the one used during multi-channel playback for playback under the bi-amplifier connection by switching the internal power amplifier during 2ch playback. • 7.1ch + Front B : Assigns power amplifiers within this unit as follows: 7.1ch for MAIN ZONE and 2ch for the second front speaker connection. • Discrete 11.1ch : Assigns 9.1ch for power amplifiers within this unit and 2ch (front/front height) for the external power amplifier connection. Up to 11.1ch playback is available. • Pre Amplifier : Connects all speakers by using an external power amplifier and uses this unit as a preamplifier. Up to 9.1ch playback is available. • Custom : Assigns power amplifiers within this unit as you prefer.







For the flow to set “Amp Assign”, see page 140.

Setting items	Setting details
Amp Assign (Continued)	The following setting items are displayed according to the setting specified for “Assign Mode” (page 141). <ul style="list-style-type: none"> <input type="checkbox"/> When “Assign Mode” (page 141) is set to “9.1ch(SB/FH/FW)”, “7.1ch + ZONE2”, “7.1ch + ZONE2/3-MONO”, “7.1ch(Bi-Amp)”, “9.1ch/2ch Front”, “7.1ch/2ch Front(Bi-Amp)” or “7.1ch + Front B” <p>Main Speakers : Selects speakers used in MAIN ZONE.</p> <ul style="list-style-type: none"> • S.Back/F.Height : Uses surround back and front height speakers. • S.Back/F.Wide : Uses surround back and front wide speakers. • F.Height/F.Wide : Uses front height and front wide speakers. <input type="checkbox"/> When “Assign Mode” (page 141) is set to “Discrete 11.1ch” <p>Main Pre-amps : Selects the PRE OUT connector that is connected to the external power amplifier used in MAIN ZONE.</p> <ul style="list-style-type: none"> • Front : Connects the PRE OUT connector for the front speaker. • Front Height : Connects the PRE OUT connector for the front height speaker. <input type="checkbox"/> When “Assign Mode” (page 141) is set to “Pre Amplifier” <p>Pre-Amp Assign : Selects how to use the PRE OUT connector.</p> <ul style="list-style-type: none"> • All : Uses this unit as a preamplifier by using only the PRE OUT connector without using the power amplifiers within this unit. • Custom : Sets whether to use each channel as a preamplifier or use speakers. <p>Center / Surround / Surr. Back / Front Height / Front Wide</p> <ul style="list-style-type: none"> • Speaker : Select to use speakers. • Pre-amp out : Select to output audio only from the PRE OUT connectors. <input type="checkbox"/> When “Assign Mode” (page 141) is set to “Custom” <p>Output Channel : Selects signals output from the selected speaker connector.</p> <ul style="list-style-type: none"> • Front / Center / Surround / Surround Back / Front Height / Front Wide / ZONE2 / ZONE3 / ZONE2/3 • None : Does not output audio from the selected speaker.

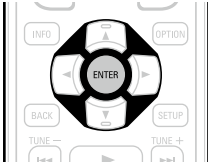
Setting items	Setting details
<p>Speaker Config. Indicate speaker presence and select speaker size categories based on bass reproduction capability.</p> <p>NOTE Do not use the outward shape of the speaker to determine selection of a "Large" or "Small" speaker. Instead, use the frequencies set in "Crossovers" (page 144) as the standard for determining bass reproduction capability.</p>	<p>Front : Set the front speaker size.</p> <ul style="list-style-type: none"> • Large : Use a large speaker that can adequately play back low frequencies. • Small : Use a small speaker that has inadequate playback capacity for low frequencies. <p> When "Subwoofer" is set to "None", "Front" is automatically set to "Large".</p> <p>• When "Front" is set to "Small", "Center", "Surround", "Surr. Back", "Front Height" and "Front Wide" can not be set to "Large".</p> <hr/> <p>Center : Set the presence and size of the center speaker.</p> <ul style="list-style-type: none"> • Large : Use a large speaker that can adequately play back low frequencies. • Small : Use a small speaker that has inadequate playback capacity for low frequencies. • None : Select when a center speaker is not connected. <p> "Large" is not displayed when "Front" is set to "Small".</p> <hr/> <p>Subwoofer : Set the presence of a subwoofer.</p> <ul style="list-style-type: none"> • 2spkrs : Use two subwoofer. • 1spkr : Use only one subwoofer. • None : Select when a subwoofer is not connected. <p> When "Front" is set to "Small", "Subwoofer" is automatically set to "1spkr".</p> <hr/> <p>Surround : Set the presence and size of the surround speakers.</p> <ul style="list-style-type: none"> • Large : Use a large speaker that can adequately play back low frequencies. • Small : Use a small speaker that has inadequate playback capacity for low frequencies. • None : Select when the surround speakers are not connected. <p> When "Surround" is set to "Large", "Surr. Back", "Front Height" and "Front Wide" can be set to "Large".</p> <p>• When "Surround" is set to "None", "Surr. Back", "Front Height" and "Front Wide" are automatically set to "None".</p>



Setting items	Setting details
<p>Speaker Config. (Continued)</p>	<p>Surr. Back : Set the presence, size and number of surround back speakers.</p> <ul style="list-style-type: none"> • Large : Use a large speaker that can adequately play back low frequencies. • Small : Use a small speaker that has inadequate playback capacity for low frequencies. • None : Select when the surround back speakers are not connected. <p>• 2spkrs : Use two surround back speakers.</p> <p>• 1spkr : Use only one surround back speaker. When you select this setting, connect the surround back speaker to the left (L) channel.</p> <hr/> <p>Front Height : Set the presence and size of the front height speakers.</p> <ul style="list-style-type: none"> • Large : Use a large speaker that can adequately play back low frequencies. • Small : Use a small speaker that has inadequate playback capacity for low frequencies. • None : Select when the front height speakers are not connected. <hr/> <p>Front Wide : Set the presence and size of the front wide speakers.</p> <ul style="list-style-type: none"> • Large : Use a large speaker that can adequately play back low frequencies. • Small : Use a small speaker that has inadequate playback capacity for low frequencies. • None : Select when the front height speakers are not connected.

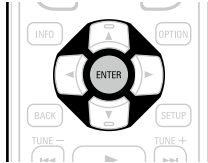



Setting items	Setting details
<p>Distances</p> <p>Set distance from listening position to speakers. Measure beforehand the distance from the listening position to each speaker.</p>	<p>Unit : Set the unit of distance.</p> <ul style="list-style-type: none"> • Feet / Meters <p>Step : Set the minimum variable width of the distance.</p> <ul style="list-style-type: none"> • 1ft / 0.1ft • 0.1m / 0.01m <p>Set Defaults : The "Distances" settings are returned to the default settings.</p> <ul style="list-style-type: none"> • Reset : Reset to the defaults. • Cancel : Do not reset to the defaults. <p> When you select "Set Defaults" and press ENTER, the "Resets all of the distance settings to the factory defaults?" prompt is displayed. Select either "Reset" or "Cancel", and press ENTER.</p> 
	<p>Front L / Front R / F. Height L / F. Height R / F. Wide L / F. Wide R / Center / Subwoofer 1*1 / Subwoofer 2*1 / Surround L / Surround R / Surr. Back L*2 / Surr. Back R*2 : Select speaker for distance setting.</p> <p>*1 When the "Speaker Config." – "Subwoofer" setting (page 142) is set to "1spkr", "Subwoofer" is displayed.</p> <p>*2 When the "Speaker Config." – "Surr. Back" setting (page 142) is set to "1spkr", "Surr. Back" is displayed.</p> <ul style="list-style-type: none"> • 0.0ft – 60.0ft / 0.00m – 18.00m : Set the distance. <p></p> <ul style="list-style-type: none"> • The speakers that can be selected differ depending on the "Amp Assign" (page 141) and "Speaker Config." (page 142) settings. • Default settings : Front L / Front R / F. Height L / F. Height R / Front Wide L / Front Wide R / Center / Subwoofer 1 / Subwoofer 2 : 12.0 ft (3.60 m) Surround L / Surround R / Surr. Back L / Surr. Back R : 10.0 ft (3.00 m) • Set the difference in the distance between the speakers to less than 20.0 ft (6.00 m). <p>NOTE</p> <p>Speakers set to "None" in "Speaker Config." (page 142) are not displayed.</p>

Setting items	Setting details
<p>Levels</p> <p>Set the volume of the test tone to be the same when it is output from each speaker.</p>	<p>Test Tone Start : Output test tone.</p> <ul style="list-style-type: none"> • Front L / F. Height L / Center / F. Height R / Front R / F. Wide R / Surround R / Surr. Back R*1 / Surr. Back L*1 / Surround L / F. Wide L / Subwoofer 1*2 / Subwoofer 2*2 / Subwoofer 1+2*3 : A test tone is output from the selected speaker. While listening to the test tone, adjust the volume output from the selected speaker. *1 When the "Speaker Config." – "Surr. Back" setting (page 142) is set to "1spkr", "Surr. Back" is displayed. *2 When the "Speaker Config." – "Subwoofer" setting (page 142) is set to "1spkr", "Subwoofer" is displayed. *3 When "Subwoofer 1+2" is selected, you can adjust the volume of Subwoofer 1 and Subwoofer 2 at the same time. <ul style="list-style-type: none"> • -12.0dB – +12.0dB (0.0dB) : Adjust the volume. <p> When "Levels" is adjusted, the adjusted values are set for all the sound modes.</p> <p>NOTE</p> <ul style="list-style-type: none"> • Speakers set to "None" in the "Speaker Config." (page 142) settings are not displayed. • When a headphones jack is inserted in the PHONES jack of this unit, the "Levels" is not displayed. <p>Set Defaults : The "Levels" settings are returned to the default settings.</p> <ul style="list-style-type: none"> • Reset : Reset to the defaults. • Cancel : Do not reset to the defaults. <p> When you select "Set Defaults" and press ENTER, the "Reset all of the channel level settings to the factory defaults?" prompt is displayed. Select either "Reset" or "Cancel", and press ENTER.</p> 

Setting items	Setting details
Crossovers Set the maximum frequency of the bass signal output from each channel to the subwoofer. Set the Crossover Frequency to suit the bass reproduction capability of the speaker being used.	<p>Speaker Selection : Selects how to set the crossover frequency. See the speaker manual for information concerning speaker crossover frequency.</p> <ul style="list-style-type: none"> • All : Selects the crossover point of all speakers at the same time. • Individual : Selects the crossover points for each speaker individually. <p>The following settings can be set when the "Speaker Selection" setting is set to "Individual".</p> <ul style="list-style-type: none"> • All / Front / Center / Subwoofer / Surround / Surr. Back / Front Height / Front Wide : Select speaker for setting of crossover frequency. • 40Hz / 60Hz / 80Hz / 90Hz / 100Hz / 110Hz / 120Hz / 150Hz / 200Hz / 250Hz : Set the crossover frequency. <p></p> <ul style="list-style-type: none"> • "Crossovers" can be set when the "Bass" – "Subwoofer Mode" (page 144) setting is "LFE+Main", or when you have a speaker that is set to "Small". • Always set the crossover frequency to "80Hz". When using small speakers, however, we recommend setting the crossover frequency to a higher frequency. • For speakers set to "Small", sound below the crossover frequency is cut from the sound output. The cut bass sound is output from the subwoofer or front speakers. • The speakers that can be set when "Individual" is selected differ depending on to the "Subwoofer Mode" setting (page 144). <ul style="list-style-type: none"> • When "LFE" is selected, speakers set to "Small" at "Speaker Config." can be set. If the speakers are set to "Large", "Full Band" is displayed and the setting cannot be made. • If set to "LFE+Main", this setting can be made regardless of the speaker size.

Setting items	Setting details
Bass Set subwoofer and LFE signal range playback.	<p>Subwoofer Mode : Select low range signals to be reproduced by subwoofer.</p> <ul style="list-style-type: none"> • LFE : The low range signal of the channel set to "Small" speaker size is added to the LFE signal output from the subwoofer. • LFE+Main : The low range signal of all channels is added to the LFE signal output from the subwoofer. <p></p> <ul style="list-style-type: none"> • "Subwoofer Mode" can be set when "Speaker Config." – "Subwoofer" (page 142) is set to other than "None". • Play music or a movie source and select the mode offering the strongest bass. • Select "LFE+Main" if you want the bass signals to always be produced from the subwoofer. <p>NOTE</p> <p>If "Front" and "Center" for "Speaker Config." are set to "Large", and "Subwoofer Mode" is set to "LFE", no sound may be output from the subwoofers, depending on the input signal or selected sound mode.</p> <p>LPF for LFE : Set LFE signal playback range. Set this when you want to change the playback frequency of the subwoofer.</p> <ul style="list-style-type: none"> • 80Hz / 90Hz / 100Hz / 110Hz / 120Hz / 150Hz / 200Hz / 250Hz

Setting items	Setting details
Impedance Set the impedance of connected speakers.	<p>8Ω/ohms : Select when the impedance per speaker for all the connected speakers is 8Ω or larger.</p> <p>6Ω/ohms : Select when the impedance for any of the connected speakers is between 6Ω and 8Ω.</p> <p>4Ω/ohms : Select when the impedance for any of the connected speakers is between 4Ω and 8Ω.</p> <p> Check the speaker impedance (Ω) shown on the back of your speakers or in the instruction manual beforehand.</p>
Front Speaker Set the front speakers to use for every sound mode.	<p>2ch Playback : The front speakers used in direct play (2 channel), stereo play and pure direct play (2 channel) are set in advance.</p> <ul style="list-style-type: none"> • A : Front speaker A is used. • B : Front speaker B is used. • A+B : Both front speakers A and B are used. <p>Multi ch Playback : The front speakers used in play modes other than direct play (2 channel), stereo play and pure direct play (2 channel) are set in advance.</p> <ul style="list-style-type: none"> • A : Front speaker A is used. • B : Front speaker B is used. • A+B : Both front speakers A and B are used. <p> This can be set when "Assign Mode" (page 141) is set to "7.1ch + Front B".</p>
2ch Playback Select the method for setting the speakers used in the 2-channel direct and stereo playback modes.	<p>Setting : Select the method for setting the speakers used in the 2-channel direct and stereo playback modes.</p> <ul style="list-style-type: none"> • Auto : The settings at "Speakers" (page 139) are applied. • Manual : Make separate settings for 2-channel. Make the following settings: <p>Front : Set the front speaker size.</p> <ul style="list-style-type: none"> • Large : Use a large speaker that can adequately play back low frequencies. • Small : Use a small speaker that has inadequate playback capacity for low frequencies. <p> If "Speaker Config." – "Subwoofer" (page 142) is set to "None", the setting is automatically set to "Large".</p>

Setting items	Setting details
2ch Playback (Continued)	<p>Subwoofer : Set the presence of a subwoofer.</p> <ul style="list-style-type: none"> • Yes : Use a subwoofer. • No : Select when a subwoofer is not connected. <p> If "Speaker Config." – "Subwoofer" (page 142) is set to "None", the setting is automatically set to "No". If the "Front" setting is "Small", the setting is automatically "Yes".</p> <p>SW Mode : Select low range signals to be reproduced by subwoofer.</p> <ul style="list-style-type: none"> • LFE : When the "2ch Playback" – "Front" setting is set to "Large", the LFE signal alone is output from the subwoofer. Also, when the "2ch Playback" – "Front" setting is set to "Small", the front channel low range signal is added to the LFE signal output from the subwoofer. • LFE+Main : The front channel low range signal is added to the LFE signal output from the subwoofer. <p> This setting can be set made "2ch Playback" – "Subwoofer" is set to "Yes".</p> <p>Crossover : Set the maximum frequency of the bass signal output from each channel to the subwoofer.</p> <p>• 40Hz / 60Hz / 80Hz / 90Hz / 100Hz / 110Hz / 120Hz / 150Hz / 200Hz / 250Hz</p> <p> This setting can be set made "2ch Playback" – "Subwoofer" is set to "Yes".</p> <ul style="list-style-type: none"> • If the "2ch Playback" – "Front" setting is "Large" and the "SW Mode" setting is "LFE", "Full Band" is displayed and the setting cannot be made. <p>Distance FL / Distance FR : Select speaker for distance setting.</p> <ul style="list-style-type: none"> • 0.0ft – 60.0ft (12.0ft) / 0.00m – 18.00m (3.60m) : Set distance from main listening point to speaker. <p> Set the difference in the distance between the speakers to less than 20.0 ft (6.00 m).</p> <p>Level FL / Level FR : Select speaker for level adjustment.</p> <ul style="list-style-type: none"> • -12dB – +12dB (0dB) : Adjust the level of each channel.



To use this unit by connecting it to a home network (LAN), you must configure network settings. If you set up your home network (LAN) via DHCP, set "DHCP" to "On" (use the default setting). This allows this unit to use your home network (LAN).

If you assign an IP address for each device, you must use the "IP Address" setting to assign an IP address to this unit and enter the information about your home network (LAN) such as the gateway address and subnet mask.

Menu operation

1 Press **ZONE SELECT** to switch the zone mode.
The **[M]** indicator lights.

2 Press **SETUP**.
The menu is displayed on the TV screen.

3 Use Δ / ∇ to select the menu to be set or operated.

4 Press **ENTER** or \triangleright to enter the setting.

- To return to the previous item, press \triangleleft or **BACK**.
- Exiting the Menu, press **SETUP** while the menu is displayed.
The menu display disappears.

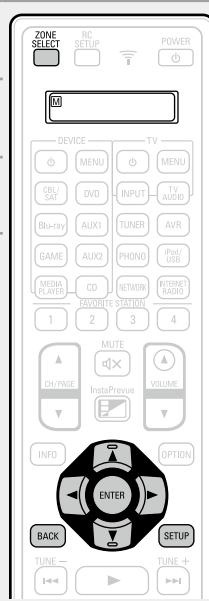

Items that can be set with the "Network" procedure

Information (👉 page 147)

Network (👉 page 147)

Friendly Name (👉 page 147)

Settings (👉 page 148)

Diagnostics (👉 page 149)

Maintenance Mode (👉 page 149)

Information

Display network information.

Setting details

Friendly Name / DHCP On or Off / IP Address / MAC Address

 MAC Address is required to make a vTuner account.

Network

Default settings are underlined.

Enables network communication in standby power mode.

Setting details

Off In Standby : Suspend network function during standby.

Always On : Network is on during standby. Main unit operable with a network compatible controller.



- Set to "Always On" when using the web control function.
- With the "Always On" setting, you can use each NETWORK connector as the hub even while power to this unit is set to standby.

NOTE

When "Network" is set to "Always On", it consumes more standby power.

Friendly Name

The Friendly Name is the name of this unit displayed on the network. You can change the Friendly Name according to your preferences.

Setting items

Edit Name

Edits Friendly Name.

Set Defaults

Restores Friendly Name, which you had changed, to the default setting.

Setting details

- The default Friendly Name on first use is "DENON AVR-4520CI".
- Up to 63 characters can be input.
- For character input, see [page 118](#).

Reset : Reset to the defaults.

Cancel : Do not reset to the defaults.

 When you select "Set Defaults" and press **ENTER**, the "Reset the friendly name back to the factory default?" prompt is displayed. Select either "Reset" or "Cancel", and press **ENTER**.

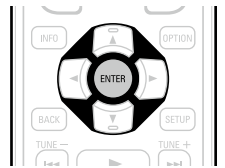

Settings

Default settings are underlined.

Make settings for wired LAN.

Only set "Settings" when connecting to a network without a DHCP function.

Setting details

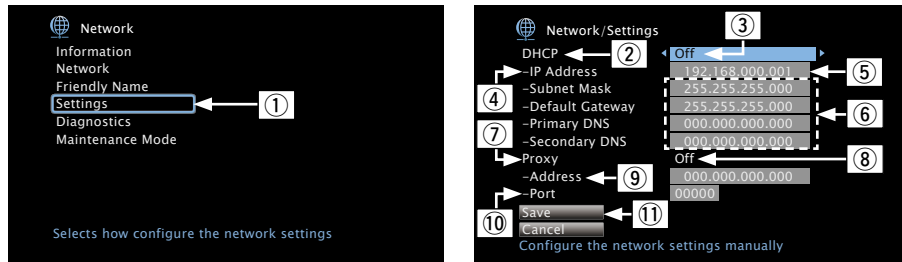

① On the menu, select "Network" – "Settings" and press **ENTER**.

② Use $\Delta \nabla$ to select "DHCP", then press **ENTER**.

③ Use $\triangleleft \triangleright$ to select "Off", then press **ENTER**.

④ Use $\Delta \nabla$ to select "IP Address", then press **ENTER**.

• **IP Address** : Set the IP address within the ranges shown below.

The Network Audio function cannot be used if other IP addresses are set.

CLASS A: 10.0.0.1 – 10.255.255.254

CLASS B: 172.16.0.1 – 172.31.255.254

CLASS C: 192.168.0.1 – 192.168.255.254

⑤ Use $\Delta \nabla \triangleleft \triangleright$ or **0 – 9** to input the address and press **ENTER**.

⑥ Use $\Delta \nabla$ to select setting item, then press **ENTER**.

• **Subnet Mask** : When connecting an xDSL modem or terminal adapter directly to this unit, input the subnet mask indicated in the documentation supplied by your provider. Normally input 255.255.255.0.

• **Default Gateway** : When connected to a gateway (router), input its IP address.

• **Primary DNS, Secondary DNS** : If there is only one DNS address indicated in the documentation supplied by your provider, input it at "Primary DNS". If two or more DNS are provided by your provider, enter both "Primary DNS" and "Secondary DNS".

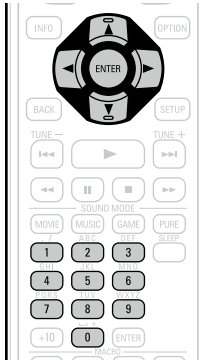

Setting details

⑦ Use $\Delta \nabla$ to select "Proxy" and press **ENTER**.

• **Proxy** : Make this setting when connecting to the Internet via a proxy server.

Make the proxy settings only when you connect to the Internet via a proxy server that is on your internal network or provided by your provider, etc.

⑧ Use $\triangleleft \triangleright$ to select "On(Address)" or "On(Name)", and then press **ENTER**.

On(Address) : Select when inputting by address.

On(Name) : Select when inputting by domain name. Up to 38 characters can be input.

⑨ Press ∇ to select "Address" or "Name", then press **ENTER**.

When "Address" is selected in step ⑧ : Use $\Delta \nabla \triangleleft \triangleright$ or **0 – 9** to enter the proxy server address, and press **ENTER**.

When "Name" is selected in step ⑧ : Use the software keyboard ([page 118](#)) to enter the domain name, and select **OK**.

• For character input, see [page 118](#).

⑩ Press ∇ to select "Port", then press **ENTER**. Use $\Delta \nabla \triangleleft \triangleright$ or **0 – 9** to input the proxy server port number and press **ENTER**.

Setup is complete.

⑪ Press ∇ to select "Save", then press **ENTER**.

The display returns to the original screen.



• If you are using a broadband router (DHCP function), there is no need to make the settings at "IP Address" and "Proxy", since the DHCP function is set to "On" in this unit's default settings.

• If this unit is being used connected to a network without the DHCP function, the network settings must be made. In this case, some knowledge of networks is required. For details, consult a network administrator.

• If you cannot connect to the Internet, recheck the connections and settings ([page 31](#)).

• If you do not understand about Internet connection, contact your ISP (Internet Service Provider) or the store from which you purchased your computer.

• When you want to cancel the setting during IP address input, select "Cancel", then press **ENTER**.

Diagnostics

Used to check the network connection.

Setting items	Setting details
Physical Connection Checks the physical LAN port connection.	OK : Connected. Error : The LAN cable is not connected. Check the connection.
Router Access Checks the connection from this unit to the router.	OK : Accessed. Error : Failed to communicate with the router. Check the router settings.
Internet Access Checks whether this unit has access to the Internet (WAN).	OK : Connected. Error : Failed to connect to the Internet. Check the Internet connection environment or router settings.

Maintenance Mode

Use when receiving maintenance from a DENON service engineer or custom installer.

Setting details

NOTE

Only use this function if so instructed by a DENON serviceperson or installer.



Make various other settings.

Menu operation

- 1** Press **ZONE SELECT** to switch the zone mode.
The **[M]** indicator lights.
- 2** Press **SETUP**.
The menu is displayed on the TV screen.
- 3** Use **△▽** to select the menu to be set or operated.
- 4** Press **ENTER** or **▷** to enter the setting.
 - To return to the previous item, press **◀** or **BACK**.
 - Exiting the Menu, press **SETUP** while the menu is displayed.
The menu display disappears.

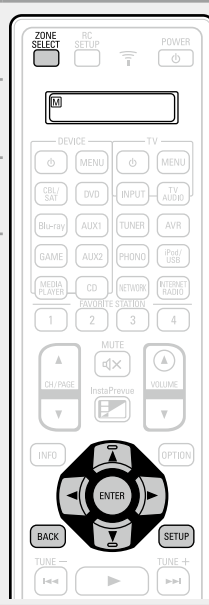

Items that can be set with the “General” procedure

Language (👉 page 151)

ZONE2 Setup / ZONE3 Setup (👉 page 151)

Zone Rename (👉 page 152)

Quick Select Names (👉 page 152)

Remote ID (👉 page 152)

Trigger Out 1 / Trigger Out 2 (👉 page 152)

Auto Standby (👉 page 153)

Front Display (👉 page 153)

Information (👉 page 153)

Firmware (👉 page 154)

Setup Lock (👉 page 156)

Language

Default settings are underlined.

Set the language for display on the menu screen.

Setting details

English / Français / Español



"Language" can also be set by the following procedure. However, the menu screen is not displayed. Following the display content to make the setting.

1. Press and hold the main unit's $\triangleleft \triangleright$ for at least 3 seconds.
" *Video Format < NTSC >" appears on the display.
2. Press the main unit's ∇ and set " *GUI Language < ENGLISH >".
3. Use the main unit's $\triangleleft \triangleright$ and set the language.
4. Press the main unit's **ENTER** to complete the setting.

ZONE2 Setup / ZONE3 Setup

Default settings are underlined.

Set the audio to play back with multi-zone (ZONE2, ZONE3).

Setting items	Setting details
Bass Adjust bass tones.	-10dB - +10dB (0dB)
Treble Adjust treble tones.	-10dB - +10dB (0dB)
High Pass Filter Make settings for cutting the low range to reduce distortion in the bass.	On : The low range is attenuated. Off : The low range is not attenuated.
Lch Level Adjust the left channel output level.	-12dB - +12dB (0dB)
Rch Level Adjust the right channel output level.	-12dB - +12dB (0dB)

Setting items	Setting details
Channel Set the signal output from multi-zone.	Stereo : Select stereo output. Mono : Select monaural output. When "Assign Mode" (page 141) is set to "7.1ch + ZONE2/3-MONO", the "Channel" setting is automatically set to "Mono".
Volume Level Set the volume output level.	Variable : Volume adjustment is enabled by main unit and remote control unit. 40 (-40dB) : Fix volume at 40 (-40 dB). Set when adjusting volume by external amplifier. 80 (0dB) : Fix volume at 80 (0 dB). Set when adjusting volume by external amplifier. When "Assign Mode" (page 141) is set to "7.1ch + ZONE2", "5.1ch + ZONE2/3", "7.1ch + ZONE2/3-MONO" or "5.1ch(Bi-Amp) + ZONE2", the "Volume Level" setting is automatically set to "Variable".
Volume Limit Make a setting for maximum volume.	60 (-20dB) / 70 (-10dB) / 80 (0dB) Off : Do not set a maximum volume. This is displayed from -79 dB to 18 dB when "Scale" (page 124) is set to "-79.5dB - 18.0dB".
Power On Volume Define the volume setting that is active when the power is turned on.	Last : Use the memorized setting from the last session. Mute : Always mute when power is turned on. 1 - 98 (-79dB - 18dB) : The volume is adjusted to the set level. This is displayed from -79 dB to 18 dB when "Scale" (page 124) is set to "-79.5dB - 18.0dB".
Mute Level Set the amount of attenuation when muting is on.	Full : The sound is muted entirely. -40dB : The sound is attenuated by 40 dB down. -20dB : The sound is attenuated by 20 dB down.

Zone Rename

Change the display title of each zone to one you prefer.

Setting details

MAIN ZONE / ZONE2 / ZONE3 / ZONE4

- Up to 10 characters can be input.
- For character input, see [page 118](#).

Set Defaults : The input source name is returned to the default setting.

- **Reset** : Reset to the defaults.
- **Cancel** : Do not reset to the defaults.

- ✎ If you select "Set Defaults" and press **ENTER**, the message "Reset to the default values?" is displayed. Select "Reset" or "Cancel", and then press **ENTER**.

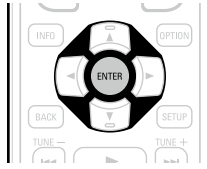

Quick Select Names

Change the "Quick Select" display title to one you prefer.

Setting details

Quick Select 1 / Quick Select 2 / Quick Select 3 / Quick Select 4

- Up to 16 characters can be input.
- For character input, see [page 118](#).

Set Defaults : The input source name is returned to the default setting.

- **Reset** : Reset to the defaults.
- **Cancel** : Do not reset to the defaults.

- ✎ If you select "Set Defaults" and press **ENTER**, the message "Reset to the default values?" is displayed. Select "Reset" or "Cancel", and then press **ENTER**.

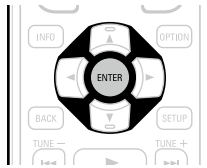

Remote ID

Set when you operate another DENON AV amplifier with the remote control unit of this unit. Match the remote control unit you are using with the remote ID of this unit.

Setting details

How to set the remote ID

1. Press **ZONE SELECT** to switch the zone mode.
The **[M]** indicator lights.
2. Press **SETUP**.
The menu is displayed on the TV screen.
3. Use Δ / ∇ to select "General" then press **ENTER**.
4. Use Δ / ∇ to select "Remote ID" then press **ENTER**.
5. Change the ID for the remote control unit ([page 167](#)).
6. Press **ENTER**.
The Remote ID for this unit is set to the same ID as the one for the remote control unit.

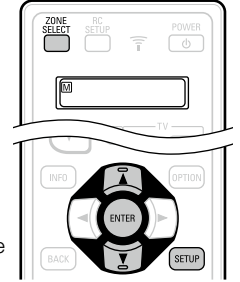

Trigger Out 1 / Trigger Out 2

Selects when to activate trigger out.

For details about how to connect the TRIGGER OUT jacks, see "TRIGGER OUT jacks" ([page 30](#)).

Setting details

When setting for zone (MAIN ZONE / ZONE2 / ZONE3 / ZONE4)

Trigger out is activated through linkage to the power of the zone set to "On".

When setting for input source

Activate trigger out when the input source set to "On" is selected.

- ✎ Active for the zone set to "On" with "When setting for zone".

When setting for HDMI monitor

Activate trigger out when the HDMI monitor set to "On" is selected.

- ✎ Activate trigger out when the HDMI monitor set to "On" is selected. Active when the "MAIN ZONE" set to "On" with "When setting for zone" is selected, and when the input source set to "On" with "When setting for input source" is selected.

- **On** : Activate trigger on this mode.
- **---** : Do not activate trigger on this mode.

Auto Standby

Default settings are underlined.

When you do not perform any operation on this unit with no audio or video input for a specified time, this unit automatically enters the standby mode. Before it enters the standby mode, "Auto Standby" is displayed on the display of this unit and the menu screen.

Setting details

60min : The unit goes into standby after 60 minutes.

30min : The unit goes into standby after 30 minutes.

Off : The unit does not go into standby automatically.

Front Display

Default settings are underlined.

Makes settings related to the display on this unit.

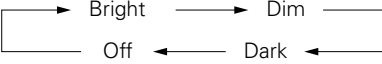
Setting items	Setting details
Dimmer Adjust the display brightness of this unit.	<p>Bright : Normal display brightness. Dim : Reduced display brightness. Dark : Very low display brightness. Off : Turns the display off.</p> <p> Buttons on the main unit can be used for operations. Each time DIMMER is pressed, the setting is changed as shown below.</p> <div style="text-align: center;">  </div> <p>NOTE When "Dimmer" is set to "Off", the display turns off and appears as if there is no electricity.</p>
Channel Indicators Sets whether to use the input signal display or output signal display for the channel indication on the display.	<p>Input : Uses the input signal display for the channel indication on the display. Output : Uses the output signal display for the channel indication on the display.</p>

Information

Show information about receiver settings, input signals, etc.

NOTE

This item is not compatible with the HDMI ZONE4 function.

Items	Setting details
Audio Show information about audio input signals.	<p>Sound Mode : The currently set surround mode. Input Signal : The input signal type. Format : The number of input signal channels (presence of front, surround, LFE). Sample Rate : The input signal's sampling frequency. Offset : The dialogue normalization correction value. Flag : This is displayed when inputting signals including a surround back channel. "MATRIX" is displayed with Dolby Digital EX and DTS-ES Matrix signals, "DISCRETE" with DTS-ES Discrete signals.</p> <div style="border: 1px solid black; padding: 5px; margin: 10px 0;"> <p style="text-align: center;">Dialogue normalization function</p> <p>This function is automatically activated when playing Dolby Digital, Dolby Digital Plus, Dolby TrueHD, DTS and DTS-HD sources. It automatically corrects the standard signal level for individual program sources. The correction value can be checked using the STATUS on the main unit.</p> <div style="border: 1px solid black; padding: 5px; text-align: center; margin: 5px 0;"> Dial.Norm Offset - 4dB </div> <p style="text-align: center;">The figure is the corrected value. This cannot be changed.</p> </div>
Video Show information about HDMI input/output signals and HDMI monitors.	<p>HDMI Signal Info.</p> <ul style="list-style-type: none"> • Resolution / Color Space / Pixel Depth <p>HDMI Monitor 1 / HDMI Monitor 2</p> <ul style="list-style-type: none"> • Interface / Resolutions

Items	Setting details
ZONE Show information about current settings.	<p>MAIN ZONE : This item shows information about settings for MAIN ZONE. The information displayed differs according to the input source.</p> <p>• ZONE Name / Select Source / Name / Sound Mode / Input Mode / Decode Mode / HDMI / Digital / Analog / Component / Video / Rec Select / Video Select / Video Mode / Content Type / Video Conversion / i/p Scaler / Resolution / Progressive Mode / Aspect Ratio etc.</p> <p>ZONE2/3/4 : This item shows information about settings for ZONE2, ZONE3 or ZONE4.</p> <p>• ZONE Name / Power / Select Source / Volume Level</p> <p>NOTE For ZONE4, "Volume Level" is not displayed.</p>
Firmware	Version : Displays information for the current firmware.



Press **INFO** to display current source name, volume, sound mode name, and other information at the bottom of the screen.

Examples of screen display

- Status display screen
When the input source is switched.



- When the volume is adjusted.

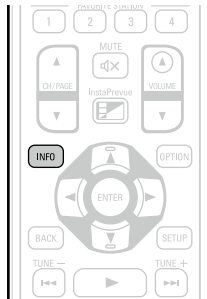
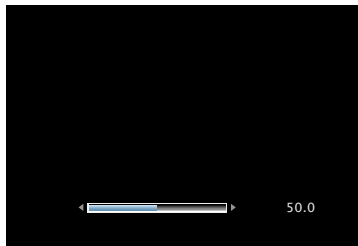

Status display: The operating status appears briefly on the screen when the input source is switched or the volume is changed.

NOTE

The status display screen cannot be displayed at a computer's resolution (e.g. VGA) or while certain 3D video contents is being played.

Firmware

Default settings are underlined.

Set whether or not to check for firmware update, update the firmware, and display update and upgrade notifications.

Setting items	Setting details												
<p>Update Update the firmware of the receiver.</p> <p>NOTE In cases where it is not possible to connect to the network after doing a firmware update, connect to the network again using "Network" (page 146).</p>	<p>Check for Update : Check for firmware updates. You can also check approximately how long it will take to complete an update.</p> <p>Update Start : Execute the update process.</p> <p>When updating starts, the power indicator becomes red and the menu screen is shut down. The amount of update time which has elapsed is displayed.</p> <p>When updating is complete, the power indicator becomes green and normal status is resumed.</p> <ul style="list-style-type: none"> If updating fails, the set automatically retries, but if updating is still not possible, one of the messages shown below is displayed. If the display reads as shown below, check the settings and network environment, then update again. <table border="1"> <thead> <tr> <th>Display</th> <th>Description</th> </tr> </thead> <tbody> <tr> <td>Updating fail</td> <td>Updating failed.</td> </tr> <tr> <td>Login failed</td> <td>Failure to log into server.</td> </tr> <tr> <td>Server is busy</td> <td>Server is busy. Wait a while then try again.</td> </tr> <tr> <td>Connection fail</td> <td>Failure in connecting to server.</td> </tr> <tr> <td>Download fail</td> <td>Downloading of the firmware has failed.</td> </tr> </tbody> </table>	Display	Description	Updating fail	Updating failed.	Login failed	Failure to log into server.	Server is busy	Server is busy. Wait a while then try again.	Connection fail	Failure in connecting to server.	Download fail	Downloading of the firmware has failed.
Display	Description												
Updating fail	Updating failed.												
Login failed	Failure to log into server.												
Server is busy	Server is busy. Wait a while then try again.												
Connection fail	Failure in connecting to server.												
Download fail	Downloading of the firmware has failed.												

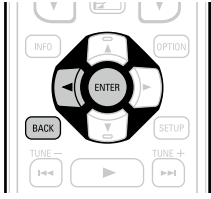
Setting items	Setting details
<p>Notifications</p> <p>Displays a notification message on this unit's menu screen when the latest firmware is released with "Update".</p> <p>Display a notification message on this unit's menu screen when downloadable firmware is released with "Add New Feature".</p>	<p>Update : The notification message is displayed for about 20 seconds when the power is turned on. Connect to broadband Internet (☞ page 31) when using this function.</p> <ul style="list-style-type: none"> • On : Display update message. • Off : Do not display update message.  <ul style="list-style-type: none"> • When you press ENTER during display of the notification message, the "Check for Update" screen is displayed (Refer to page 154 for more information on "Update"). • Press < or BACK to erase the notification message. <p>Upgrade : The notification message is displayed for about 20 seconds when the power is turned on. Connect to broadband Internet (☞ page 31) when using this function.</p> <ul style="list-style-type: none"> • On : Display upgrade message. • Off : Do not display upgrade message. <ul style="list-style-type: none"> • When you press ENTER during display of the notification message, the "Add New Feature" screen is displayed (Refer to page 155 for more information on "Add New Feature"). • Press < or BACK to erase the notification message.

Setting items	Setting details
<p>Add New Feature</p> <p>Display new features that can be downloaded to this unit and perform an upgrade.</p> <p>NOTE</p> <p>In cases where it is not possible to connect to the network after adding a new function, connect to the network again using "Network" (☞ page 146).</p>	<p>Upgrade Package : Display the items to be upgraded.</p> <p>Upgrade Status : Display a list of the additional functions provided by the upgrade.</p> <p>Upgrade Start : Execute the upgrade process.</p> <p>When the upgrade starts, the power indicator becomes red and the menu screen is shut down. During the upgrade, the amount of upgrade time which has elapsed is displayed.</p> <p>When upgrading is complete, the power indicator becomes green and normal status is resumed.</p> <ul style="list-style-type: none"> • If the upgrade is not successful, an error message identical to those in "Update" will appear on the display. Check the settings and network environment and then perform the upgrade again. <ul style="list-style-type: none"> • See the DENON website for details about upgrades. <p>When the procedure is complete, "Registered" is displayed in this menu and upgrades can be carried out. If the procedure has not been carried out, "Not Registered" is displayed.</p> <p>The ID number shown on this screen is needed when carrying out the procedure.</p> <p>The ID number can also be displayed by pressing and holding the main unit's Δ and INFO for at least 3 seconds.</p>

Notes concerning use of "Update" and "Add New Feature"
<ul style="list-style-type: none"> • In order to use these functions, you must have the correct system requirements and settings for a broadband Internet connection (☞ page 31). • Do not turn off the power until updating or upgrading is completed. • Even with a broadband connection to the Internet, approximately 1 hour is required for the updating/upgrading procedure to be completed. • Once updating/upgrade starts, normal operations on this unit cannot be performed until updating/upgrading is completed. Furthermore, there may be cases where backup data is reset for the parameters, etc., set on this unit. • If the update or upgrade fails, press and hold the ⏻ on the main unit for more than 5 seconds, or remove and re-insert the power cord. "Update retry" appears on the display and update restarts from the point at which update failed. If the error continues despite this, check the network environment.

- Information regarding the "Update" function and "Add New Feature" will be announced on the DENON web site each time related plans are defined.
- When usable new firmware is released with "Update" or "Add New Feature", a notification message is displayed on the menu screen. When you do not want to be notified, set "Notifications" – "Update" (☞ [page 155](#)) and "Notifications" – "Upgrade" (☞ [page 155](#)) to "Off".

Setup Lock

Default settings are underlined.

Protect settings from inadvertent change.

Setting items	Setting details
Lock	<p>On : Turn protection on. Off : Turn protection off.</p> <p> When canceling the setting, set "Lock" to "Off".</p> <p>NOTE</p> <p>When "Lock" is set to "On", the settings listed below can no longer be changed. Also, "Setup Locked!" is displayed if you attempt to operate related settings.</p> <ul style="list-style-type: none">• Setup menu operations



Operating external devices with the remote control

By registering preset codes for external devices to the provided remote control, you can operate your TV and playback devices (such as Blu-ray Disc player and DVD player) with the remote control.

Registering preset codes

When preset codes are registered in the included remote control unit, it can then be used to operate any devices you have, such as DVD players or TVs made by different manufacturers.

Buttons used for operating the devices

- ① **DEVICE**  For switching power of each device on or off.
- ② **△▽◀▶, ENTER, BACK** For menu operation of each device.
- ③ **MENU, INFO, OPTION, SETUP** For displaying the menu of each device.
- ④ **◀◀, ▶▶, ▶, ◀, ▶▶, II, ■**
- ⑤ Number button (0 – 9, +10)
- ⑥ **CH/PAGE** 
- ⑦ **TV** , **TV INPUT** For operating a TV
This button is enabled in any mode.

For details on operation with the remote control unit, see pages [46](#), [49](#), [58](#), [61](#), [65](#), [68](#), [71](#), [73](#), [75](#), [161](#), [162](#).

NOTE

The preset code cannot be registered to **TUNER**, **PHONO**, **iPod/USB**, **NETWORK** and **INTERNET RADIO**.

Registering preset codes

- 1** Press and hold **RC SETUP** for at least 3 seconds.
“SETUP” and  indicator flashes twice on the remote control unit.
- 2** When “PRSET” appears on the remote control unit, press **ENTER**.
- 3** When “DEVIC” appears on the remote control unit, press the input source select button of the AV equipment (**CBL/SAT**, **Blu-ray**, **GAME**, **MEDIA PLAYER**, **DVD**, **AUX1**, **AUX2** or **CD**) that you want to program for the preset setting.

NOTE

Note that the group numbers that can be registered are predefined for each input source select button ([page 158](#)).

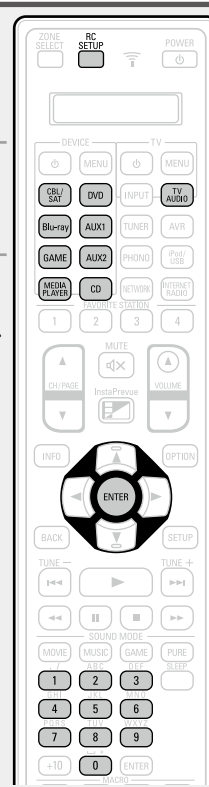

- 4** When “-----” appears on the remote control unit, press the number buttons **0 – 9** to enter a 5-digit code ([page 205](#) “List of preset codes”).
Press the buttons with an interval less than 30 seconds.

- When the code is registered
→ “OK” flashes four times on the remote control unit.
- When the code is not registered correctly
→ “FAIL” or “CANCL” flashes four times on the remote control unit.
Perform from step 1 again.



Some manufacturers use more than one type of remote control code. Preset codes to change the number and verify correct operation.

NOTE

Depending on the model and year of manufacture of your device, some buttons may not operate.

Remote control operation modes

By default, the input source select buttons on the remote control perform only the input source select operation. To operate an external device with this remote control, set the preset code in "List of preset codes" (page 205) for the device you want to register to each input source select button. For how to set preset codes to buttons, see "Registering preset codes" (page 157).

If you register preset codes on this remote control, the input source select buttons on the remote control can perform the following two functions.

- ① The function to switch input sources on this unit (AVR operation mode)
- ② The function to make this remote control switch to the mode in which you can operate the device registered to the button (External device operation mode)

How to switch operation modes

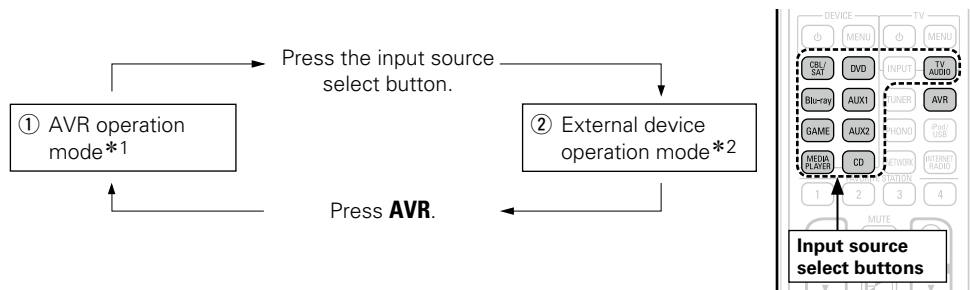

- *1 The mode in which you can operate this unit.
- *2 If you press one of these buttons, the input source on this unit changes and the remote control switches to the mode in which you can operate the external device registered to that button.

Devices that can be registered to input source select buttons on the remote control

The types of devices that can be registered to each input source select button on this remote control are assigned as shown in the following table. Register the preset code under the desired device name in "List of preset codes" (page 205).

Preset codes that can be registered to CBL/SAT, Blu-ray, GAME, MEDIA PLAYER, DVD, AUX1, AUX2, and CD buttons

Button	Default preset mode	Available change to preset
CBL/SAT	AVR	CBL/SAT group
Blu-ray		VCR/PVR group BD/DVD group
GAME		CBL/SAT group VCR/PVR group BD/DVD group Audio group
MEDIA PLAYER		CBL/SAT group
DVD		VCR/PVR group BD/DVD group
AUX1		CBL/SAT group VCR/PVR group BD/DVD group Audio group
AUX2		CBL/SAT group VCR/PVR group BD/DVD group Audio group
CD		Audio group

- When you press an input source select button for which a preset code has been registered, its button name appears on the display of the remote control unit.
- To unregister the device from a button and reset to the default setting, set the AVR code "73347" to the button.

Preset codes that can be registered to TV buttons

Button	Default preset mode	Available change to preset
	AVR	TV group

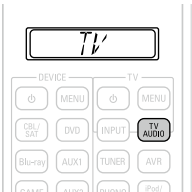

The image shows a remote control with a display at the top showing 'TV'. Below the display is a grid of buttons. The 'TV AUDIO' button is highlighted with a dark background, indicating it is the active mode.

- When you press TV AUDIO that has a preset code registered to it, the “TV” indication on the remote control lights.



To perform menu operations of this unit, press **AVR** to have the remote control enter the AVR operation mode.

Operating external devices

Press the input source select button (🔍 [page 41](#)).

- The operation mode of the remote control unit is switched as shown in the table.

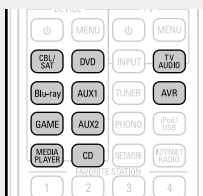

Input source select button	Input source of this unit	Operation mode
		Devices controllable with the remote control unit
AVR	–	This unit (AVR-operation) *2
CBL/SAT *1	CBL/SAT	Device registered on the CBL/SAT button
Blu-ray *1	Blu-ray	Device registered on the Blu-ray button
GAME *1	GAME	Device registered on the GAME button
MEDIA PLAYER *1	MEDIA PLAYER	Device registered on the MEDIA PLAYER button
DVD *1	DVD	Device registered on the DVD button
AUX1 *1	AUX1	Device registered on the AUX1 button
AUX2 *1	AUX2	Device registered on the AUX2 button
CD *1	CD	Device registered on the CD button
TV AUDIO *1	TV AUDIO	Device registered on the TV AUDIO button

*1 If a preset code is registered for this button, the remote control unit of this unit can control another devices.

*2 With this mode, you can operate: HD Radio, iPod, USB memory device, record player and network function.



When the **FAVORITE STATION** and **InstaPrevue** are pressed, the AVR-operation mode starts automatically.

NOTE

If the mode of the remote control unit is set to other than AVR-operation mode, press **AVR** to switch the remote control unit to the AVR-operation mode to perform the following operations:

- For menu operation by pressing **SETUP**.

Operating devices

The supplied remote control unit can control a device other than this unit.

1 Press the input source select button to which the preset code for the device you want to operate has been registered (page 160).

2 Operate the device.

• For details, refer to the device's operating instructions.



□ CBL/SAT group (0****) (Set top box for satellite (SAT) / cable (CBL) / Media player / IP TV) operation



Operation buttons	Function
DEVICE	Power on/standby*
DEVICE MENU	Menu
TV	TV power on/standby
TV INPUT	Switch TV input
CH/PAGE	Switch channels (up/down)
INFO	Information
OPTION	Sub menu, Option
	Cursor operation
ENTER (Cursor)	Enter
BACK	Return
SETUP	Home menu
	Auto search (cue)
	Playback
	Manual search (fast-reverse/fast-forward)
II	Pause
	Stop
0 - 9, +10	Channel selection
ENTER (Number)	3 digit entry

* This may turn some devices on.

□ TV group (1****) (TV) operation



Operation buttons	Function
TV	TV power on/standby*
TV MENU	TV menu
TV INPUT	Switch TV input
CH/PAGE	Switch channels (up/down)
INFO	Information
OPTION	Sub menu
	Cursor operation
ENTER (Cursor)	Enter
BACK	Return
SETUP	Setup
	Auto search (cue)
	Playback
	Manual search (fast-reverse/fast-forward)
II	Pause
	Stop
0 - 9, +10	Channel selection
ENTER (Number)	3 digit entry

* This may turn some devices on.

❑ **VCR/DVR group (2* * * *)**
(DVD recorder (DVR) / Personal video recorder (PVR) / video cassette recorder (VCR)) operation



Operation buttons	Function
DEVICE ⏻	Power on/standby*
DEVICE MENU	Menu
TV ⏻	TV power on/standby
TV INPUT	Switch TV input
CH/PAGE ▲▼	Switch channels (up/down)
INFO	Information
OPTION	Sub menu, Option
△▽◀▶	Cursor operation
ENTER	Enter
BACK	Return
SETUP	Setup
⏮ ⏪ ⏩ ⏭	Auto search (cue)
▶	Playback
◀◀ ▶▶	Manual search (fast-reverse/fast-forward)
⏸	Pause
■	Stop
0 - 9, +10	Select title, chapter or channel selection

* This may turn some devices on.

❑ **BD/DVD group (3* * * *)**
(Blu-ray Disc player / HD-DVD player / DVD player) operation

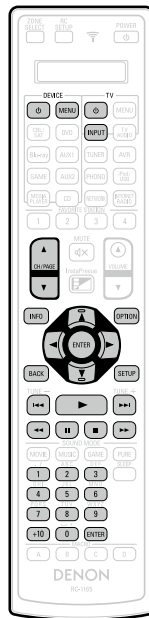

Operation buttons	Function
DEVICE ⏻	Power on/standby*
DEVICE MENU	(Popup) Menu
TV ⏻	TV power on/standby
TV INPUT	Switch TV input
CH/PAGE ▲▼	Switch channels (up/down)
INFO	Information
OPTION	Top menu
△▽◀▶	Cursor operation
ENTER	Enter
BACK	Return
SETUP	Setup
⏮ ⏪ ⏩ ⏭	Auto search (cue)
▶	Playback
◀◀ ▶▶	Manual search (fast-reverse/fast-forward)
⏸	Pause
■	Stop
0 - 9, +10	Select title, chapter or channel selection

* This may turn some devices on.
 (Only the power-on operation is available for some DENON model devices as well.)

❑ **Audio group (4* * * *)**
(CD player / CD recorder) operation



Operation buttons	Function
DEVICE ⏻	Power on/standby*
TV ⏻	TV power on/standby
TV INPUT	Switch TV input
△▽◀▶	Cursor operation
ENTER	Enter
⏮ ⏪ ⏩ ⏭	Auto search (cue)
▶	Playback
◀◀ ▶▶	Manual search (fast-reverse/fast-forward)
⏸	Pause
■	Stop
0 - 9, +10	Track selection

* This may turn some devices on.
 (Only the power-on operation is available for some DENON model devices as well.)

Operating learning function

If the AV device is not a DENON device, or if the device does not operate even when the preset code is registered, use the learning function. Remote codes for different devices can be remembered for use by the DENON remote control included with this device.

Remembering remote control codes from other devices

1 Press and hold **RC SETUP** for at least 3 seconds.

"SETUP" and  indicator flashes twice on the remote control unit.

2 Use Δ / ∇ to display "LEARN" on the remote control unit and press **ENTER**.

3 When "DEVIC" appears on the remote control unit, press the input source select button of the AV equipment that you want to store.

- You cannot store the remote control code in the **AVR** button.
- Before using the learning function, register a preset code ([page 157](#) "Registering preset codes") for a mode other than AVR preset ([page 158](#)) to each input source switch button.

4 When "KEY" appears on the remote control unit, press the button that you want to store.

- You cannot store the remote control code in the **ZONE SELECT**, **RC SETUP**, **POWER**, **FAVORITE STATION 1 – 4**, **InstaPrevue**, **SOUND MODE**, **SLEEP**, **MACRO A – D** and input source select button.

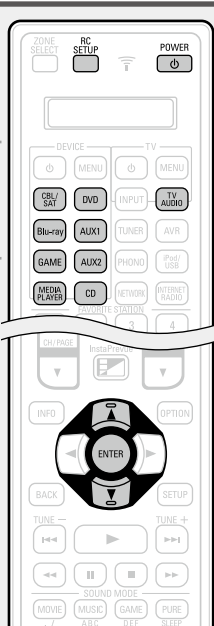

5 When "READY" appears on the remote control unit, place the remote control unit of the AV equipment face to face with main remote control unit (of this unit). Next, press and hold down the desired button (that you want to store) of the remote control unit of the AV equipment.

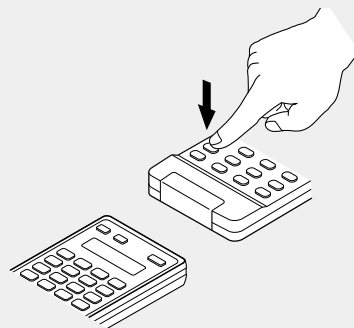

- When the button is correctly stored, "OK" flashes four times on the remote control unit.
- If the button is not correctly stored, "FAIL" flashes four times on the remote control unit. If this happens, perform step 4 again.

6 To store another button, repeat steps 4 and 5.

7 When you have finished storing the remote control codes, press **RC SETUP**.

"OK" flashes four times on the remote control unit and the normal operation mode is restored.



- There are some remote control units that cannot be programmed, or even if they can be programmed, they may not operate correctly. If this happens, use the remote control unit supplied with the AV equipment to operate it.
- The operations of the programmed buttons override the preset memory. If you do not require the programmed buttons, erase the stored remote control codes to return to the initial settings ([page 164](#) "Erasing stored remote control codes").
- The number of buttons that can be stored varies depending on the remote control unit used. If you have stored the maximum number of buttons allowed for the remote control unit, "FAIL" appears on its display.

Erasing stored remote control codes

Erasing the code by each button

- 1** Press and hold **RC SETUP** for at least 3 seconds.
"SETUP" and  indicator flashes twice on the remote control unit.
- 2** Use Δ / ∇ to display "RESET" on the remote control unit and press **ENTER**.
- 3** When "LEARN" appears on the remote control unit, press **ENTER**.
- 4** When "DEVIC" appears on the remote control unit, press the input source select button of the AV equipment that you want to erase.
- 5** Use Δ / ∇ to display "ONE" on the remote control unit and press **ENTER**.
- 6** When "KEY" appears on the remote control unit, press the button that you want to erase.
"RESET" flashes four times on the remote control unit and the normal operation mode is restored.

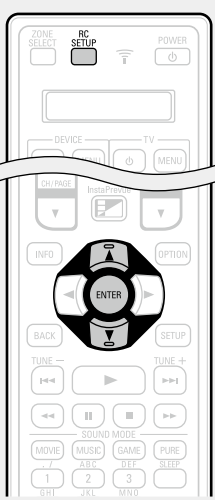

Erasing the code by each equipment input source

- 1** Press and hold **RC SETUP** for at least 3 seconds.
"SETUP" and  indicator flashes twice on the remote control unit.
- 2** Use Δ / ∇ to display "RESET" on the remote control unit and press **ENTER**.
- 3** When "LEARN" appears on the remote control unit, press **ENTER**.
- 4** When "DEVIC" appears on the remote control unit, press the input source select button of the AV equipment that you want to erase.
- 5** When "ALL" appears, press **ENTER**.
"RESET" flashes four times on the remote control unit and the normal operation mode is restored.

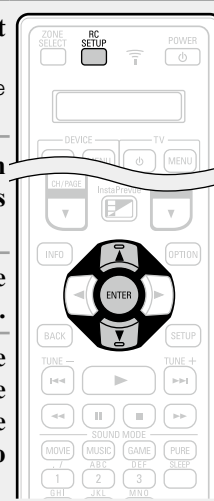

Operating macro function

- When the macro function is used, operations that usually require a complicated series of multiple button operations can be performed easily just by pressing the **MACRO** button.
- This device can remember up to 4 macro functions.
- Each macro can record a maximum of 18 steps.

[Example]

When the following set of operations has been registered to the **MACRO** button, you can simply press the **MACRO** button to turn on the TV and this unit and start playing back Blu-ray.

- ① Turn the TV's power on
↓
- ② Turn this unit's power on
↓
- ③ Switch this unit's input source to "Blu-ray"
↓
- ④ Turn the Blu-ray Disc player's power on
↓
- ⑤ Play the Blu-ray Disc player

Recording automatic macro operations

You can automatically set the macro for your scene:

- (1) Watch movies (MOVIE)
- (2) Listen to music (MUSIC)
- (3) Watch TV (CBL/SAT) (WATCH)
- (4) Turn on all devices (ON)
- (5) Turn off all devices (OFF)

NOTE

- Register preset codes for the remote control unit before setting Auto macro (see page 157).
- Depending on the type or model of your device, macro may not work properly even if it is set.

1 Press and hold RC SETUP for at least 3 seconds.

"SETUP" and  indicator flashes twice on the remote control unit.

2 Use Δ / ∇ to display "MACRO" on the remote control unit and press ENTER.

3 Use Δ / ∇ to display "AUTO" on the remote control unit and press ENTER.

4 When "MCNo" appears on the remote control unit, press the MACRO A – D button that you want to set.

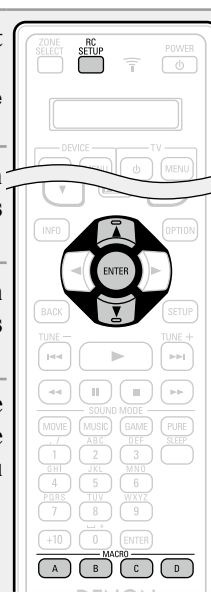

5 Use Δ / ∇ to set the auto macro operation and press ENTER.

"OK" flashes four times on the remote control unit and the normal operation mode is restored.

Remote control unit display	Auto MACRO
MOVIE	Automatically turns on the devices and starts playback when you watch movies. <div style="border: 1px solid black; padding: 2px;"> TV power ON Blu-ray power ON AVR Power ON Source Change Blu-ray Playback Blu-ray </div>
MUSIC	Automatically turns on the devices and starts playback when you listen to music. <div style="border: 1px solid black; padding: 2px;"> CD power ON AVR Power ON Source Change CD Playback CD </div>
WATCH	Automatically turns on the devices and starts playback when you watch TV (CBL/SAT). <div style="border: 1px solid black; padding: 2px;"> TV power ON CBL/SAT Power ON AVR Power ON Source change CBL/SAT </div>
ON	Turns on all the devices set for PRESET. <div style="border: 1px solid black; padding: 2px;"> All DEVICE POWER ON </div>
OFF	Turns off all the devices set for PRESET. <div style="border: 1px solid black; padding: 2px;"> All DEVICE POWER OFF </div>

Recording custom macro operations

1 Press and hold **RC SETUP** for at least 3 seconds.

"SETUP" and  indicator flashes twice on the remote control unit.

2 Use Δ / ∇ to display "MACRO" on the remote control unit and press **ENTER**.

3 Use Δ / ∇ to display "MAN" on the remote control unit and press **ENTER**.

4 When "MCNo" appears on the remote control unit, press the **MACRO A – D** button that you want to store.

5 Press the buttons to be stored one by one.

• The step number for the storing procedure and mode are alternately displayed on the remote control unit.

NOTE

You cannot store the macros for the **ZONE SELECT** button.

6 Press **MACRO** to exit the macro function.

"OK" flashes four times on the remote control unit and the normal operation mode is restored.

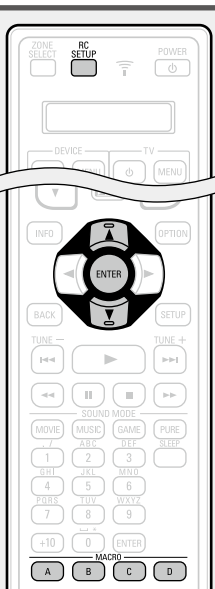

Adjusting the interval time of macro operations transmitting

The macro operation transmission interval can be adjusted.

• The factory setting is "0.5 sec".

1 Press and hold **RC SETUP** for at least 3 seconds.

"SETUP" and  indicator flashes twice on the remote control unit.

2 Use Δ / ∇ to display "MACRO" on the remote control unit and press **ENTER**.

3 Use Δ / ∇ to display "MAN" on the remote control unit and press **ENTER**.

4 When "MCNo" appears on the remote control unit, press the **MACRO A – D** button that you want to set.

5 Press **RC SETUP**.

6 Use Δ / ∇ to set the macro operation transmission interval and press **ENTER**.

"OK" flashes four times on the remote control unit and the normal operation mode is restored.

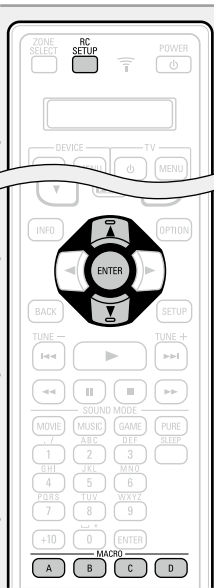

Remote control unit display	Time values that you can set
0.25	0.25 sec
0.50	0.5 sec
0.75	0.75 sec
1.00	1 sec
1.25	1.25 sec

Using the macro function

Press the **MACRO A – D** button you used to store the macro function.

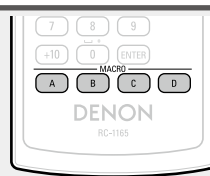

Resetting the macro function

1 Press and hold **RC SETUP** for at least 3 seconds.

"SETUP" and  indicator flashes twice on the remote control unit.

2 Use Δ / ∇ to display "RESET" on the remote control unit and press **ENTER**.

3 Use Δ / ∇ to display "MACRO" on the remote control unit and press **ENTER**.

4 When "MCNo" appears on the remote control unit, press the **MACRO A – D** button that you want to reset.

"RESET" flashes four times on the remote control unit and the normal operation mode is restored.

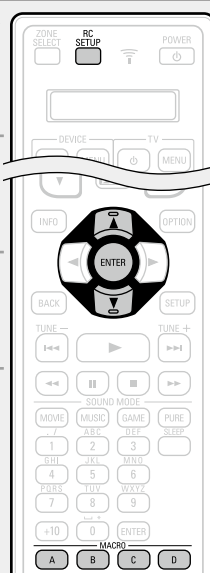

Specifying the zone used with the remote control unit

When the **ZONE SELECT** button is pressed, only the set zone can be operated with the remote control unit.

- The factory setting is "M234".

1 Press and hold RC SETUP for at least 3 seconds.

"SETUP" and  indicator flashes twice on the remote control unit.

2 Use Δ / ∇ to display "ZLOCK" on the remote control unit and press ENTER.

3 Use Δ / ∇ to set the zone to be used and press ENTER.

"OK" flashes four times on the remote control unit and the normal operation mode is restored.

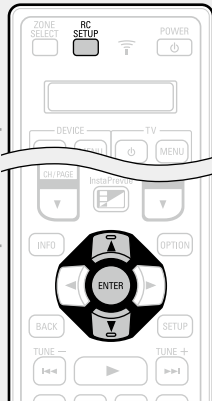

Remote control unit display	Zone to be used
M	MAIN ZONE only
M2	MAIN ZONE / ZONE2
M23	MAIN ZONE / ZONE2 / ZONE3
M234	MAIN ZONE / ZONE2 / ZONE3 / ZONE4

Setting the Remote ID

When using multiple DENON AV receivers in the same room, make this setting so that only the desired AV receiver operates.

- The factory setting is "ID-1".

1 Press and hold RC SETUP for at least 3 seconds.

"SETUP" and  indicator flashes twice on the remote control unit.

2 Use Δ / ∇ to display "RC-ID" on the remote control unit and press ENTER.

3 Use Δ / ∇ to set the remote ID and press ENTER.

"OK" flashes four times on the remote control unit and the normal operation mode is restored.

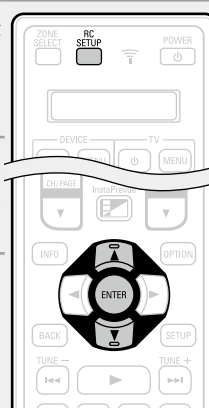

Remote control unit display	Remote ID
ID-1	1
ID-2	2
ID-3	3
ID-4	4

NOTE

When you change the remote ID, make sure that the remote control unit and the remote ID of the main unit are exactly the same ([page 152](#) "Remote ID").

Setting the display time length of the remote control unit display

Use the following procedure to set the length of time for which to display data such as zone and mode on the display panel of the remote control unit.

1 Press and hold RC SETUP for at least 3 seconds.

"SETUP" and  indicator flashes twice on the remote control unit.

2 Use Δ / ∇ to display "DISPL" on the remote control unit and press ENTER.

3 Use Δ / ∇ to set the display time length and press ENTER.

"OK" flashes four times on the remote control unit and the normal operation mode is restored.

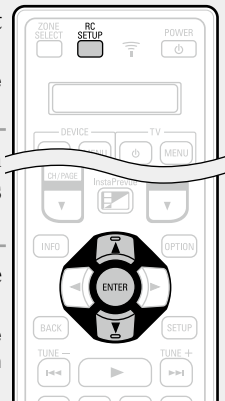

Remote control unit display	Display time
05SEC	5 sec
10SEC	10 sec
15SEC	15 sec

Setting the back light

You can set the back light on the remote control unit to off to prolong the life of the dry cell batteries.

1 Press and hold RC SETUP for at least 3 seconds.

"SETUP" and  indicator flashes twice on the remote control unit.

2 Use Δ / ∇ to display "LIGHT" on the remote control unit and press ENTER.

3 Use Δ / ∇ to set the back light and press ENTER.

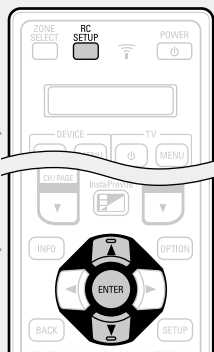

Remote control unit display	Back light
ON	Back light on
OFF	Back light off

Restoring all settings of the remote control unit to default

Use the following procedure to restore all default settings of the remote control unit at the time of purchase.

1 Press and hold RC SETUP for at least 3 seconds.

"SETUP" and  indicator flashes twice on the remote control unit.

2 Use Δ / ∇ to display "RESET" on the remote control unit and press ENTER.

3 Use Δ / ∇ to display "ALL" on the remote control unit and press ENTER.



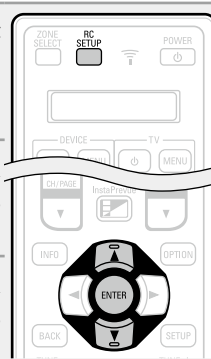

4 Use Δ / ∇ to display "YES" on the remote control unit and press ENTER.

"RESET" flashes four times on the remote control unit and the normal operation mode is restored.



Informations

Here, we list various information related to this unit.
Please refer to this information as needed.

- Part names and functions  [page 170](#)
- Other information  [page 176](#)
- Troubleshooting  [page 196](#)
- Specifications  [page 202](#)
- Index  [page 203](#)

Part names and functions

Front panel

For buttons not explained here, see the page indicated in parentheses ().

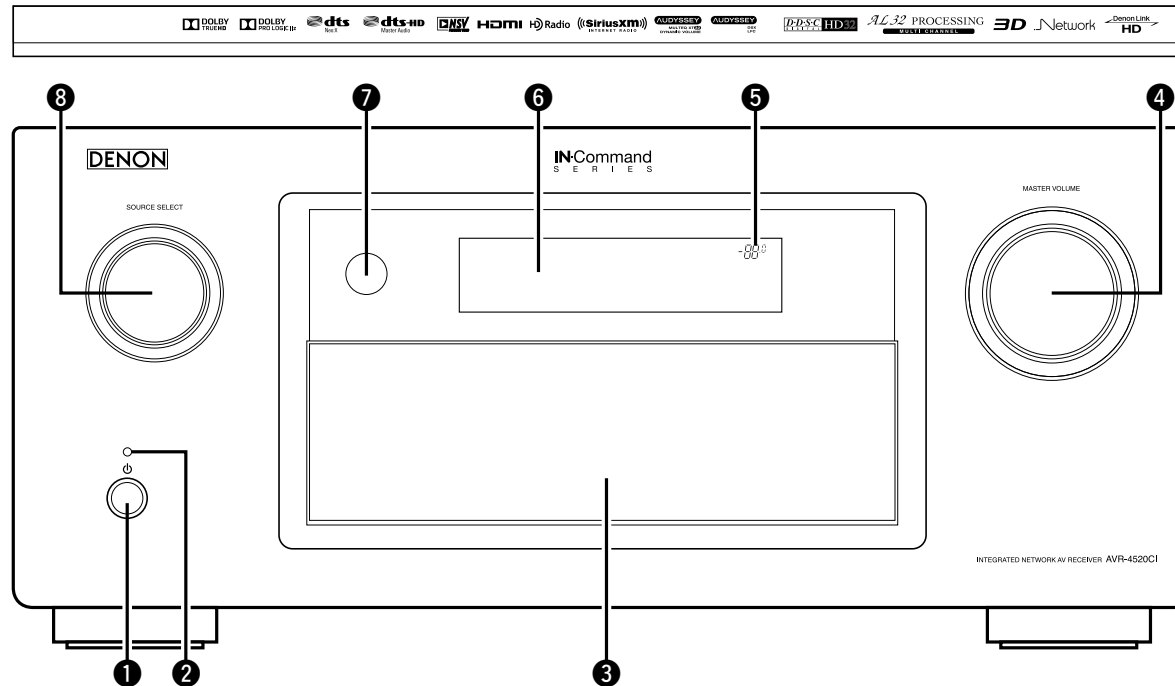

- 1 Power operation button (⏻)** (41)
Turns power to this unit on and off (standby).
- 2 Power indicator** (41)
[Power indicator status]
- Power on : Green
 - Normal standby : Off
 - When "HDMI Pass Through" or "HDMI Control" (page 130) is set to "On" : Red
 - When "Network" (page 147) is set to "Always On" : Red
 - When a mobile device that supports MHL is being charged : Red

- 3 Door**
- When you are using buttons and/or connectors behind the door, press the bottom of the door to open it. When not using buttons and/or connectors behind the door, close it. Be careful not to catch your fingers when closing the door.

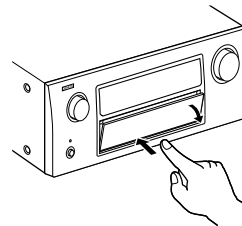

- 4 MASTER VOLUME knob** (42, 113)
- 5 Master volume indicator**
- 6 Display** (172)
- 7 Remote control sensor** (175)
- 8 SOURCE SELECT knob** (41, 113)

With the door open

For buttons not explained here, see the page indicated in parentheses ().

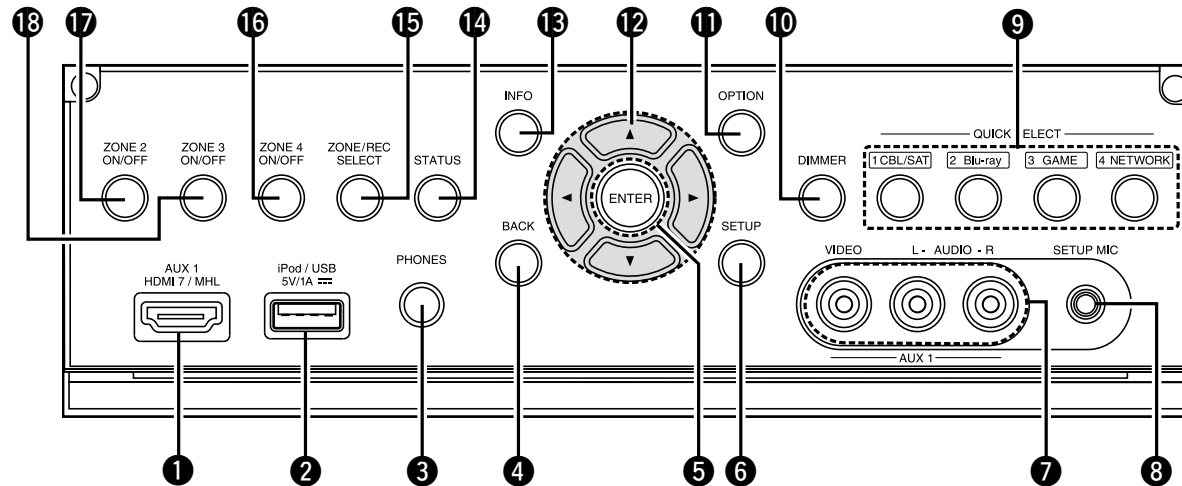

- | | | |
|--|---|---|
| <p>1 AUX1 HDMI 7 / MHL connector (12)</p> <p>2 iPod/USB port (23)</p> <p>3 Headphones jack (PHONES)
When the headphones are plugged into this jack, audio will no longer be output from the connected speakers or from the PRE OUT connectors.</p> <p>NOTE
To prevent hearing loss, do not raise the volume level excessively when using headphones.</p> | <p>4 BACK button (48, 60, 64, 67, 72, 75, 201)</p> <p>5 ENTER button (117, 120, 128, 134, 139, 146, 150)</p> <p>6 SETUP button (117, 120, 128, 134, 139, 146, 150)</p> <p>7 AUX1 INPUT connectors (21)</p> <p>8 SETUP MIC jack (34, 99)</p> <p>9 QUICK SELECT buttons (106)</p> <p>10 DIMMER button (153)</p> <p>11 OPTION button
..... (44, 48, 51, 60, 65, 67, 75, 104)</p> | <p>12 Cursor buttons
($\Delta \nabla \triangleleft \triangleright$) (117, 120, 128, 134, 139, 146, 150)</p> <p>13 Information button (INFO) (154)</p> <p>14 STATUS button (45, 58, 60, 64, 75, 153)</p> <p>15 ZONE/REC SELECT button (107, 113)</p> <p>16 ZONE4 ON/OFF button (113)</p> <p>17 ZONE2 ON/OFF button (113)</p> <p>18 ZONE3 ON/OFF button (113)</p> |
|--|---|---|

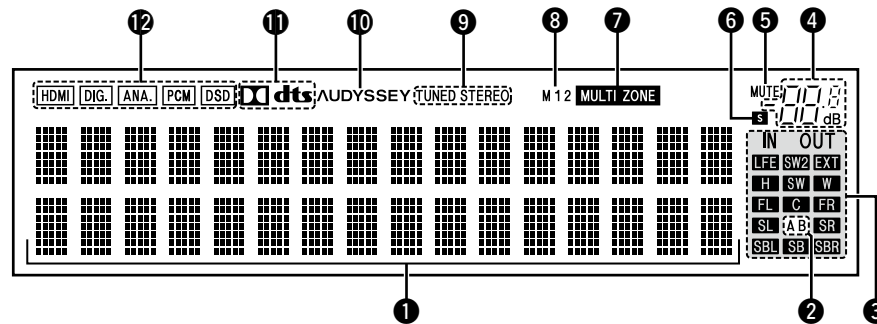

1 Information display

The input source name, sound mode, setting values and other information are displayed here.

2 Front speaker indicator

This lights according to the setting of the front A and B speakers.

3 Output signal channel indicators

Lights when audio signals are being output from the speakers.

4 Master volume indicator

5 MUTE indicator

This lights when the mute mode is selected ([page 42](#)).

6 Sleep timer indicator

This lights when the sleep mode is selected ([page 105](#)).

7 MULTI ZONE indicators

This lights up when ZONE2, ZONE3 or ZONE4 (separate room) power is turned on ([page 113](#)).

8 Monitor output indicator

These light according to the HDMI monitor output setting.

When set to "Auto(Dual)", the indicators light according to connection status.

9 Tuner reception mode indicators

These light according to the reception conditions when the input source is set to "HD Radio".

STEREO : In FM mode, this lights up when receiving stereo broadcasts.

TUNED : Lights up when the broadcast is properly tuned in.

10 Audyssey® indicator

This indicator lights when the "MultEQ® XT 32" ([page 125](#)), "Dynamic EQ" ([page 125](#)), "Dynamic Volume" ([page 126](#)), "Audyssey DSX®" ([page 126](#)) or "Audyssey LFC™" ([page 126](#)) setting is set to other than "Off".

11 Decoder indicator

These light when Dolby or DTS signals are input or when the Dolby or DTS decoder is running.

12 Input mode indicators

Set the audio input modes for the different input sources ([page 138](#)).

Rear panel

See the page indicated in parentheses ().

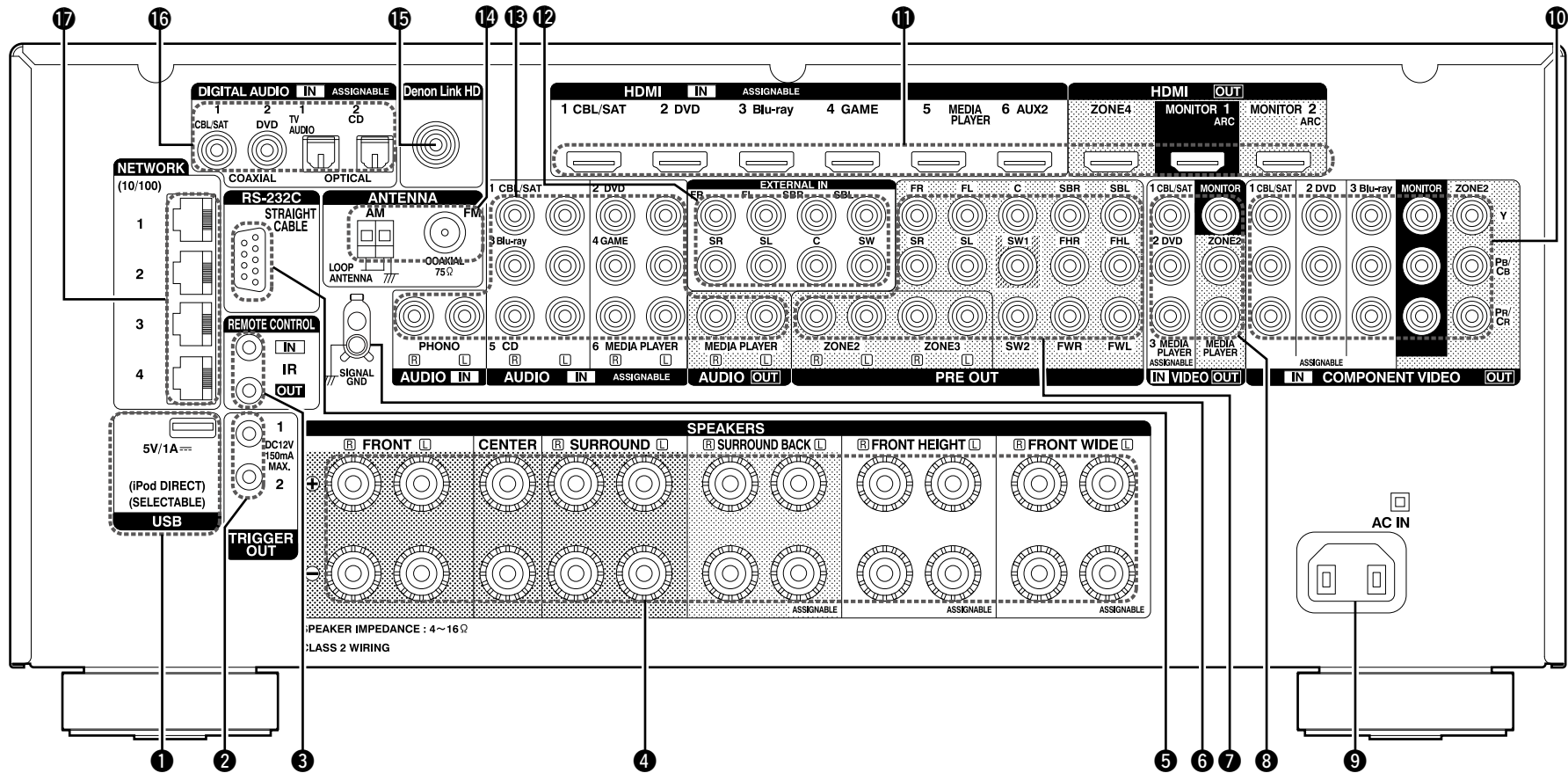

- | | | |
|--|--|--|
| ① USB port (23) | ⑨ AC inlet (AC IN) (32) | ⑬ Digital audio connectors (DIGITAL AUDIO) (16, 17, 18, 25) |
| ② TRIGGER OUT jacks (30) | ⑩ Component video connectors (COMPONENT VIDEO) (16, 17, 18, 19, 112) | ⑭ Network connectors (NETWORK) (31) |
| ③ REMOTE CONTROL jacks (30) | ⑫ EXTERNAL IN connectors (28) | NOTE |
| ④ Speaker terminals (SPEAKERS) (94, 95, 96, 97, 111) | ⑪ HDMI connectors (11, 12, 112) | Do not touch the inner pins of the connectors on the rear panel. Electrostatic discharge may cause permanent damage to the unit. |
| ⑤ RS-232C connector (30) | ⑬ Analog audio connectors (AUDIO) (17, 18, 19, 20, 22, 25, 26) | |
| ⑥ SIGNAL GND terminal (26) | ⑭ FM/AM antenna terminals (ANTENNA) (27) | |
| ⑦ PRE OUT connectors (29, 94, 95, 96, 97, 98, 112) | ⑮ Denon Link HD connector (13) | |
| ⑧ Video connectors (VIDEO) (16, 17, 18, 22, 112) | | |

Remote control unit

For buttons not explained here, see the page indicated in parentheses ().

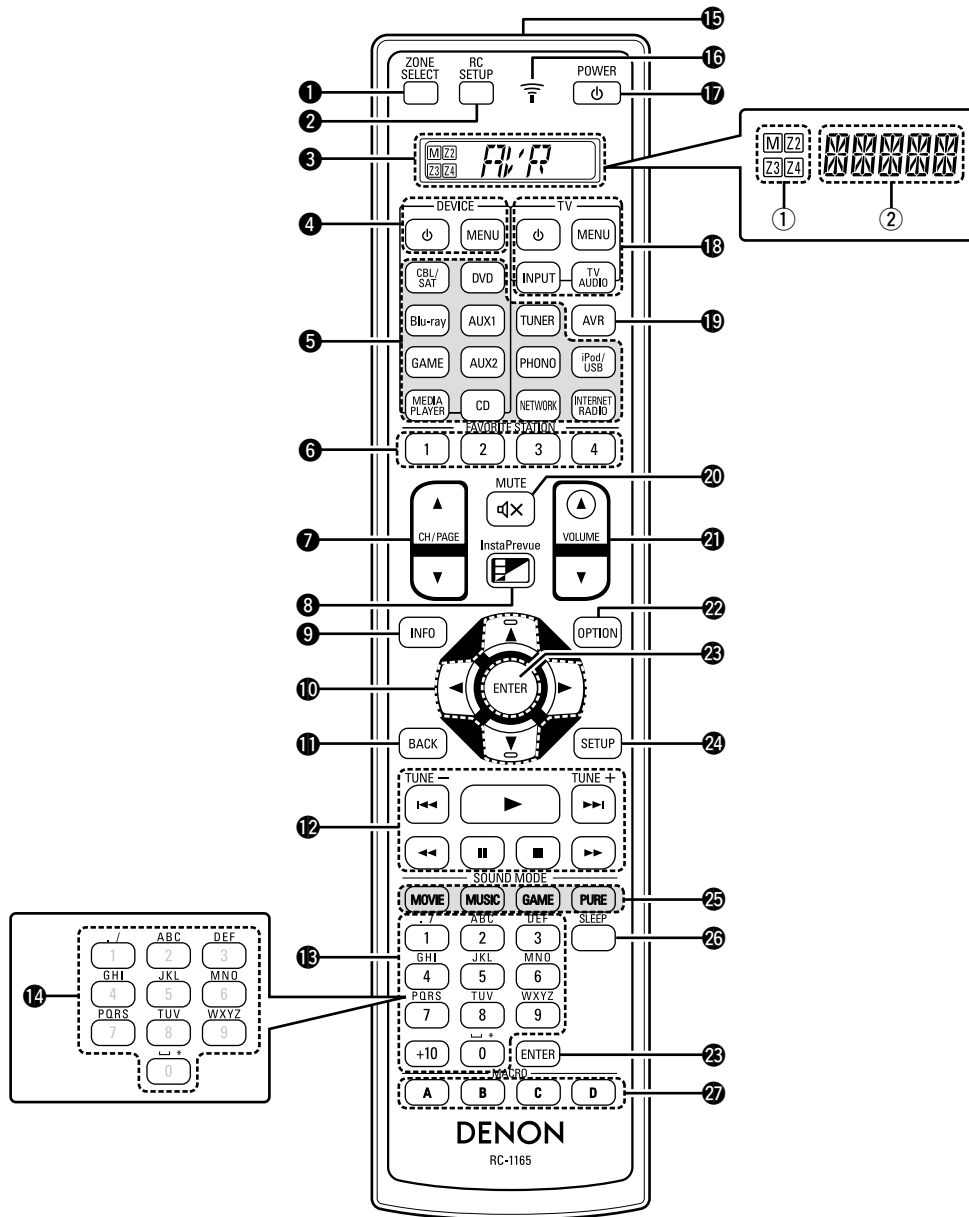

- 1 ZONE SELECT button** (34, 80, 99, 113, 167)
- 2 RC SETUP button** (157, 163, 165, 167, 168)
- 3 Display**
 - ① Zone select indicators (34, 99, 113, 167)
 - ② Operation mode indicator
- 4 Device operation buttons (DEVICE ϕ / DEVICE MENU)** (161, 162)
- 5 Input source select buttons** (41, 113)
- 6 FAVORITE STATION buttons (1 – 4)** (78)
- 7 Channel/page search buttons (CH/PAGE \blacktriangle \blacktriangledown)** (46, 49, 55, 58, 61, 65, 68, 71, 73, 75, 161, 162)
- 8 InstaPrevue button** (104)
- 9 Information button (INFO)** (154)
- 10 Cursor buttons (\blacktriangle \blacktriangledown \blacktriangleleft \blacktriangleright)** (117, 120, 128, 134, 139, 146, 150)
- 11 BACK button** (48, 60, 64, 67, 72, 75)
- 12 System buttons** (46, 49, 61, 65, 68, 71, 73, 75, 161, 162)
 - Skip buttons (\blacktriangleleft \blacktriangleright)
 - Play button (\blacktriangleright)
 - Search buttons (\blacktriangleleft \blacktriangleright)
 - Pause button (\blacksquare)
 - Stop button (\blacksquare)
- Tuning up / Tuning down buttons (TUNE +, -)** (51, 52)
- 13 Number buttons** (53, 55, 119, 157)
- 14 Character buttons** (119)
- 15 Remote control signal transmitter** (175)
- 16 POWER button (ϕ)** (41, 113)
- 17 Wi-Fi indicator** (157, 163, 165, 167, 168)
- 18 TV operation buttons (TV ϕ / TV MENU / TV INPUT)** (58, 61, 65, 68, 161, 162)
- 19 AVR-operation mode button** (158, 160)
- 20 MUTE button (M)** (42, 113)
- 21 VOLUME buttons (\blacktriangle \blacktriangledown)** (42, 113)
- 22 OPTION button** (44, 48, 51, 60, 65, 67, 75, 104)
- 23 ENTER button** (117, 120, 128, 134, 139, 146, 150)
- 24 SETUP button** (117, 120, 128, 134, 139, 146, 150)
- 25 SOUND MODE buttons** (84)
 - MOVIE button
 - MUSIC button
 - GAME button
 - PURE button
- 26 SLEEP button** (105, 113)
- 27 MACRO buttons (A – D)** (165, 166)



The remote control unit for this unit is automatically lit when you touch it. This is useful for operating the remote control unit in a dark room such as when watching movies in a theater room. The time for which the backlight stays on can be changed (see page 168 “Setting the back light”).

Inserting the batteries

- ① Slide the rear cover off the remote control unit in the arrow direction.
- ② Load the two batteries properly as indicated by the marks in the battery compartment.

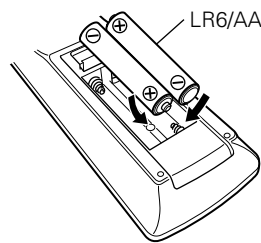
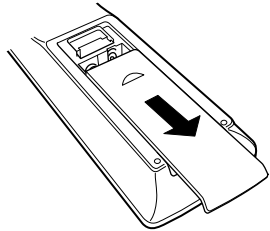

- ③ Put the rear cover back on.

NOTE

- Insert the specified batteries in the remote control unit.
- Replace the batteries with new ones if the set does not operate even when the remote control unit is operated close to the unit. (The supplied batteries are only for verifying operation. Replace them with new batteries at an early date.)
- When inserting the batteries, be sure to do so in the proper direction, following the ⊕ and ⊖ marks in the battery compartment.
- To prevent damage or leakage of battery fluid:
 - Do not use a new battery together with an old one.
 - Do not use two different types of batteries.
 - Do not attempt to charge dry batteries.
 - Do not short-circuit, disassemble, heat or dispose of batteries in flames.
 - Do not keep the battery in a place exposed to direct sunlight or in places with extremely high temperatures, such as near a heater.
- If the battery fluid should leak, carefully wipe the fluid off the inside of the battery compartment and insert new batteries.
- Remove the batteries from the remote control unit if it will not be in use for long periods.
- Used batteries should be disposed of in accordance with the local regulations regarding battery disposal.
- The remote control unit may function improperly if rechargeable batteries are used.

Operating range of the remote control unit

Point the remote control unit at the remote sensor when operating it.

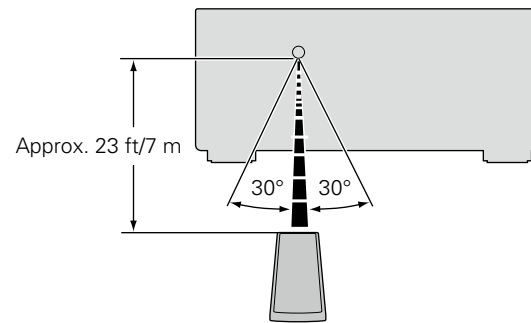

NOTE





- The set may function improperly or the remote control unit may not operate if the remote control sensor is exposed to direct sunlight, strong artificial light from an inverter type fluorescent lamp or infrared light.
- When using 3D video devices that transmit radio communication signals (such as infrared signals etc) between the various units (such as the monitor, 3D glasses, 3D transmitter unit etc), the remote control unit may not operate due to interference from those radio communication signals. If this occurs, adjust the direction and distance of the 3D communication for each unit, and check that the remote control unit operation is not affected by these signals.



Other information

- ❑ **Trademark information** ([page 176](#))
- ❑ **Relationship between the Amp Assign mode settings and audio output** ([page 177](#))
- ❑ **Surround** ([page 184](#))
- ❑ **Relationship between video signals and monitor output** ([page 190](#))
- ❑ **Explanation of terms** ([page 193](#))

Trademark information

This product uses the following technologies (Random order):

	
<p>Manufactured under license from Audyssey Laboratories™. U.S. and foreign patents pending. Audyssey MultEQ® XT 32, Audyssey Dynamic EQ®, Audyssey Dynamic Volume® and Audyssey DSX® are registered trademarks of Audyssey Laboratories. Audyssey LFC™ is a trademark of Audyssey Laboratories.</p>	
	
<p>Manufactured under license from Dolby Laboratories. "Dolby", "Pro Logic" and the double-D symbol are trademarks of Dolby Laboratories.</p>	

	
<p>Manufactured under license under U.S. Patent No's:5,956,674;5,974,380;5,978,762;6,487,535;6,226,616;7,212,872;7,003,467;7,272,567;7,668,723;7,392,195;7,930,184;7,333,929;7,548,853;7,283,634 & other U.S. and worldwide patents issued and pending. DTS-HD, the Symbol, & DTS-HD and the Symbol together are registered trademarks & DTS -HD Master Audio is a trademark of DTS, Inc. Product includes software. ©DTS, Inc. All Rights Reserved.</p>	
	
<p>The terms HDMI and HDMI High-Definition Multimedia Interface, and the HDMI Logo are trademarks or registered trademarks of HDMI Licensing LLC in the United States and other countries.</p>	
	
<p>InstaPrevue and the InstaPrevue logo are trademarks or registered trademarks of Silicon Image, Inc. in the United States and other countries.</p>	

	
<p>"Made for iPod" and "Made for iPhone" mean that an electronic accessory has been designed to connect specifically to iPod, or iPhone, respectively, and has been certified by the developer to meet Apple performance standards. Apple is not responsible for the operation of this device or its compliance with safety and regulatory standards. Please note that the use of this accessory with iPod, or iPhone, may affect wireless performance. AirPlay, the AirPlay logo, iPad, iPhone, iPod, iPod classic, iPod nano, iPod shuffle and iPod touch are trademarks of Apple Inc., registered in the U.S. and other countries.</p> <ul style="list-style-type: none"> • Individual users are permitted to use iPhone, iPod, iPod classic, iPod nano, iPod shuffle, and iPod touch for private copy and playback of non-copyrighted contents and contents whose copy and playback is permitted by law. Copyright infringement is prohibited by law. 	
	
<p>MHL, the MHL Logo, and Mobile High-Definition Link are trademark or registered trademarks of MHL LLC in the United States and other countries.</p>	
	
<p>Windows Media and the Windows logo are trademarks or registered trademarks of Microsoft Corporation in the United States and/or other countries.</p>	
<p>This item incorporates copy protection technology that is protected by U.S. patents and other intellectual property rights of Rovi Corporation. Reverse engineering and disassembly are prohibited.</p>	

Relationship between the Amp Assign mode settings and audio output

On this unit, you can change how the power amplifiers within this unit are used according to your environment.

This allows you to output audio to rooms other than the room where the surround is played back (MAIN ZONE) and to enjoy high-quality playback from the front speaker in MAIN ZONE.



- Set the Amp Assign mode by referring to “Assign Mode” ([page 141](#)).
- For speaker connection, see “Speaker connection” ([page 93](#)).

NOTE

When making a bi-amplifier connection, use speakers that support the bi-amplifier connection. In this case, remove the short-circuit plate or short-circuit wire from the speaker connector.

□ When “9.1ch(SB/FH/FW)” is selected for “Assign Mode”

Assigns all power amplifiers within this unit for MAIN ZONE. Up to 9.1ch playback is available.

	Speaker terminal										
	FL	FR	C	SL	SR	SBL	SBR	FHL	FHR	FWL	FWR
Output signal	FL	FR	C	SL	SR	SBL	SBR	FHL	FHR	FWL	FWR

	Pre out terminal																
	FL	FR	C	SL	SR	SBL	SBR	FHL	FHR	FWL	FWR	SW1	SW2	Z2L	Z2R	Z3L	Z3R
Output signal	FL	FR	C	SL	SR	SBL	SBR	FHL	FHR	FWL	FWR	SW1	SW2	Z2L	Z2R	Z3L	Z3R

□ Audio is output from the optimum speakers based on the selected sound mode.

When “7.1ch + ZONE2” is selected for “Assign Mode”

Assigns power amplifiers within this unit as follows: 7.1ch for MAIN ZONE and 2ch for ZONE2.
 Select the desired speakers used for MAIN ZONE from the “Main Speakers” settings.

		Speaker terminal										
		FL	FR	C	SL	SR	SBL	SBR	FHL	FHR	FWL	FWR
Output signal												
Main Speakers	S.Back/F.Height	FL	FR	C	SL	SR	SBL	SBR	FHL	FHR	Z2L	Z2R
	S.Back/F.Wide	FL	FR	C	SL	SR	SBL	SBR	Z2L	Z2R	FWL	FWR
	F.Height/F.Wide	FL	FR	C	SL	SR	Z2L	Z2R	FHL	FHR	FWL	FWR

		Pre out terminal																
		FL	FR	C	SL	SR	SBL	SBR	FHL	FHR	FWL	FWR	SW1	SW2	Z2L	Z2R	Z3L	Z3R
Output signal																		
Main Speakers	S.Back/F.Height	FL	FR	C	SL	SR	SBL	SBR	FHL	FHR	–	–	SW1	SW2	Z2L	Z2R	Z3L	Z3R
	S.Back/F.Wide	FL	FR	C	SL	SR	SBL	SBR	–	–	FWL	FWR	SW1	SW2	Z2L	Z2R	Z3L	Z3R
	F.Height/F.Wide	FL	FR	C	SL	SR	–	–	FHL	FHR	FWL	FWR	SW1	SW2	Z2L	Z2R	Z3L	Z3R

Audio is output from the optimum speakers based on the selected sound mode.

When “5.1ch + ZONE2/3” is selected for “Assign Mode”

Assigns power amplifiers within this unit as follows: 5.1ch for MAIN ZONE and 2ch for ZONE2 and ZONE3 each.

		Speaker terminal										
		FL	FR	C	SL	SR	SBL	SBR	FHL	FHR	FWL	FWR
Output signal		FL	FR	C	SL	SR	Z2L	Z2R	–	–	Z3L	Z3R

		Pre out terminal																
		FL	FR	C	SL	SR	SBL	SBR	FHL	FHR	FWL	FWR	SW1	SW2	Z2L	Z2R	Z3L	Z3R
Output signal		FL	FR	C	SL	SR	–	–	–	–	–	–	SW1	SW2	Z2L	Z2R	Z3L	Z3R

□ When “7.1ch + ZONE2/3-MONO” is selected for “Assign Mode”

Assigns power amplifiers within this unit as follows: 7.1ch for MAIN ZONE and 1ch for ZONE2 and ZONE3 each.
 Select the desired speakers used for MAIN ZONE from the “Main Speakers” settings.

		Speaker terminal										
		FL	FR	C	SL	SR	SBL	SBR	FHL	FHR	FWL	FWR
Output signal												
Main Speakers	S.Back/F.Height	FL	FR	C	SL	SR	SBL	SBR	FHL	FHR	Z2 MONO	Z3 MONO
	S.Back/F.Wide	FL	FR	C	SL	SR	SBL	SBR	Z2 MONO	Z3 MONO	FWL	FWR
	F.Height/F.Wide	FL	FR	C	SL	SR	Z2 MONO	Z3 MONO	FHL	FHR	FWL	FWR

		Pre out terminal																
		FL	FR	C	SL	SR	SBL	SBR	FHL	FHR	FWL	FWR	SW1	SW2	Z2L	Z2R	Z3L	Z3R
Output signal																		
Main Speakers	S.Back/F.Height	FL	FR	C	SL	SR	SBL	SBR	FHL	FHR	–	–	SW1	SW2	Z2 MONO	Z2 MONO	Z3 MONO	Z3 MONO
	S.Back/F.Wide	FL	FR	C	SL	SR	SBL	SBR	–	–	FWL	FWR	SW1	SW2	Z2 MONO	Z2 MONO	Z3 MONO	Z3 MONO
	F.Height/F.Wide	FL	FR	C	SL	SR	–	–	FHL	FHR	FWL	FWR	SW1	SW2	Z2 MONO	Z2 MONO	Z3 MONO	Z3 MONO

□ Audio is output from the optimum speakers based on the selected sound mode.

□ When “7.1ch(Bi-Amp)” is selected for “Assign Mode”

Assigns power amplifiers within this unit as follows: 7.1ch for MAIN ZONE and 2ch for the front speaker bi-amplifier connection.
 Select the desired speakers used for MAIN ZONE from the “Main Speakers” settings.

		Speaker terminal										
		FL	FR	C	SL	SR	SBL	SBR	FHL	FHR	FWL	FWR
Output signal												
Main Speakers	S.Back/F.Height	FL	FR	C	SL	SR	SBL	SBR	FHL	FHR	FL (Bi-amp)	FR (Bi-amp)
	S.Back/F.Wide	FL	FR	C	SL	SR	SBL	SBR	FL (Bi-amp)	FR (Bi-amp)	FWL	FWR
	F.Height/F.Wide	FL	FR	C	SL	SR	FL (Bi-amp)	FR (Bi-amp)	FHL	FHR	FWL	FWR

		Pre out terminal																
		FL	FR	C	SL	SR	SBL	SBR	FHL	FHR	FWL	FWR	SW1	SW2	Z2L	Z2R	Z3L	Z3R
Output signal																		
Main Speakers	S.Back/F.Height	FL	FR	C	SL	SR	SBL	SBR	FHL	FHR	–	–	SW1	SW2	Z2L	Z2R	Z3L	Z3R
	S.Back/F.Wide	FL	FR	C	SL	SR	SBL	SBR	–	–	FWL	FWR	SW1	SW2	Z2L	Z2R	Z3L	Z3R
	F.Height/F.Wide	FL	FR	C	SL	SR	–	–	FHL	FHR	FWL	FWR	SW1	SW2	Z2L	Z2R	Z3L	Z3R

□ When “5.1ch(Bi-Amp) + ZONE2” is selected for “Assign Mode”

Assigns power amplifiers within this unit as follows: 5.1ch for MAIN ZONE, 2ch for the front speaker bi-amplifier connection, and 2ch for ZONE2.

		Speaker terminal										
		FL	FR	C	SL	SR	SBL	SBR	FHL	FHR	FWL	FWR
Output signal		FL	FR	C	SL	SR	FL (Bi-amp)	FR (Bi-amp)	Z2L	Z2R	–	–

		Pre out terminal																
		FL	FR	C	SL	SR	SBL	SBR	FHL	FHR	FWL	FWR	SW1	SW2	Z2L	Z2R	Z3L	Z3R
Output signal		FL	FR	C	SL	SR	–	–	–	–	–	–	SW1	SW2	Z2L	Z2R	Z3L	Z3R

□ When “9.1ch/2ch Front” is selected for “Assign Mode”

Assigns all power amplifiers within this unit for MAIN ZONE. Up to 9.1ch playback is available. You can also use a front speaker that is different from the one used during multi-channel playback for playback by switching the internal power amplifier during 2ch playback.

Select the desired speakers used for MAIN ZONE from the “Main Speakers” settings.

		Speaker terminal										
		FL	FR	C	SL	SR	SBL	SBR	FHL	FHR	FWL	FWR
Output signal												
Main Speakers	S.Back/F.Height	FL	FR	C	SL	SR	SBL	SBR	FHL	FHR	FL for 2ch	FR for 2ch
	S.Back/F.Wide	FL	FR	C	SL	SR	SBL	SBR	FL for 2ch	FR for 2ch	FWL	FWR
	F.Height/F.Wide	FL	FR	C	SL	SR	FL for 2ch	FR for 2ch	FHL	FHR	FWL	FWR

		Pre out terminal																
		FL	FR	C	SL	SR	SBL	SBR	FHL	FHR	FWL	FWR	SW1	SW2	Z2L	Z2R	Z3L	Z3R
Output signal																		
Main Speakers	S.Back/F.Height	FL	FR	C	SL	SR	SBL	SBR	FHL	FHR	–	–	SW1	SW2	Z2L	Z2R	Z3L	Z3R
	S.Back/F.Wide	FL	FR	C	SL	SR	SBL	SBR	–	–	FWL	FWR	SW1	SW2	Z2L	Z2R	Z3L	Z3R
	F.Height/F.Wide	FL	FR	C	SL	SR	–	–	FHL	FHR	FWL	FWR	SW1	SW2	Z2L	Z2R	Z3L	Z3R

□ When “7.1ch/2ch Front(Bi-Amp)” is selected for “Assign Mode”

Assigns power amplifiers within this unit as follows: 7.1ch for the MAIN ZONE multi-channel playback. You can also use a front speaker that is different from the one used during multi-channel playback for playback under the bi-amplifier connection by switching the internal power amplifier during 2ch playback.

		Speaker terminal										
		FL	FR	C	SL	SR	SBL	SBR	FHL	FHR	FWL	FWR
Output signal		FL	FR	C	SL	SR	SBL	SBR	FL (Bi-amp) for 2ch	FR (Bi-amp) for 2ch	FL (Bi-amp) for 2ch	FR (Bi-amp) for 2ch

		Pre out terminal																
		FL	FR	C	SL	SR	SBL	SBR	FHL	FHR	FWL	FWR	SW1	SW2	Z2L	Z2R	Z3L	Z3R
Output signal		FL	FR	C	SL	SR	SBL	SBR	–	–	–	–	SW1	SW2	Z2L	Z2R	Z3L	Z3R

□ When “7.1ch + Front B” is selected for “Assign Mode”

Assigns power amplifiers within this unit as follows: 7.1ch for MAIN ZONE and 2ch for the second front speaker connection. Select the desired speakers used for MAIN ZONE from the “Main Speakers” settings.

		Speaker terminal										
		FL	FR	C	SL	SR	SBL	SBR	FHL	FHR	FWL	FWR
Output signal												
Main Speakers	S.Back/F.Height	FL A	FR A	C	SL	SR	SBL	SBR	FHL	FHR	FL B	FR B
	S.Back/F.Wide	FL A	FR A	C	SL	SR	SBL	SBR	FL B	FR B	FWL	FWR
	F.Height/F.Wide	FL A	FR A	C	SL	SR	FL B	FR B	FHL	FHR	FWL	FWR

		Pre out terminal																
		FL	FR	C	SL	SR	SBL	SBR	FHL	FHR	FWL	FWR	SW1	SW2	Z2L	Z2R	Z3L	Z3R
Output signal																		
Main Speakers	S.Back/F.Height	FL	FR	C	SL	SR	SBL	SBR	FHL	FHR	–	–	SW1	SW2	Z2L	Z2R	Z3L	Z3R
	S.Back/F.Wide	FL	FR	C	SL	SR	SBL	SBR	–	–	FWL	FWR	SW1	SW2	Z2L	Z2R	Z3L	Z3R
	F.Height/F.Wide	FL	FR	C	SL	SR	–	–	FHL	FHR	FWL	FWR	SW1	SW2	Z2L	Z2R	Z3L	Z3R

 Audio is output from the optimum speakers based on the selected sound mode.

When “Discrete 11.1ch” is selected for “Assign Mode”

Assigns 9.1ch for power amplifiers within this unit and 2ch (front/front height) for the external power amplifier connection. Up to 11.1ch playback is available.

		Speaker terminal										
		FL	FR	C	SL	SR	SBL	SBR	FHL	FHR	FWL	FWR
Output signal												
Main Pre-amps	Front	–	–	C	SL	SR	SBL	SBR	FHL	FHR	FWL	FWR
	Front Height	FL	FR	C	SL	SR	SBL	SBR	–	–	FWL	FWR

		Pre out terminal																
		FL	FR	C	SL	SR	SBL	SBR	FHL	FHR	FWL	FWR	SW1	SW2	Z2L	Z2R	Z3L	Z3R
Output signal																		
Main Pre-amps	Front	FL	FR	C	SL	SR	SBL	SBR	FHL	FHR	FWL	FWR	SW1	SW2	Z2L	Z2R	Z3L	Z3R
	Front Height	FL	FR	C	SL	SR	SBL	SBR	FHL	FHR	FWL	FWR	SW1	SW2	Z2L	Z2R	Z3L	Z3R

When “Pre Amplifier” is selected for “Assign Mode”

Connects all speakers by using an external power amplifier and uses this unit as a preamplifier.

You can select “Custom” for the “Pre-amp Assign” setting to change settings for each channel.

		Speaker terminal										
		FL	FR	C	SL	SR	SBL	SBR	FHL	FHR	FWL	FWR
Output signal												
Pre-amp Assign	All	–	–	–	–	–	–	–	–	–	–	–
	Custom	–	–	C	SL	SR	SBL	SBR	FHL	FHR	FWL	FWR

You can set whether or not to output audio from speakers for each channel.

		Pre out terminal																
		FL	FR	C	SL	SR	SBL	SBR	FHL	FHR	FWL	FWR	SW1	SW2	Z2L	Z2R	Z3L	Z3R
Output signal																		
Pre-amp Assign	All	FL	FR	C	SL	SR	SBL	SBR	FHL	FHR	FWL	FWR	SW1	SW2	Z2L	Z2R	Z3L	Z3R
	Custom	FL	FR	C	SL	SR	SBL	SBR	FHL	FHR	FWL	FWR	SW1	SW2	Z2L	Z2R	Z3L	Z3R

When "Custom" is selected for "Assign Mode"

Assigns power amplifiers within this unit as you prefer.

	Speaker terminal											
	FL	FR	C	SL	SR	SBL	SBR	FHL	FHR	FWL	FWR	
Output signal	FL	FR	C or –	SL or –	SR or –	FL	FR	FL	FR	–	–	
	C	C				C	C					
	SL	SR				SL	SR					
	SBL	SBR				SBL	SBR					
	FHL	FHR				FHL	FHR					
	FWL	FWR				FWL	FWR					
	Z2L	Z2R				Z2L	Z2R					
	Z3L	Z3R				Z3L	Z3R					
	Z2 MONO	Z3 MONO				Z2 MONO	Z3 MONO					
	–	–				–	–					

	Pre out terminal																
	FL	FR	C	SL	SR	SBL	SBR	FHL	FHR	FWL	FWR	SW1	SW2	Z2L	Z2R	Z3L	Z3R
Output signal	FL	FR	C	SL	SR	SBL	SBR	FHL	FHR	FWL	FWR	SW1	SW2	Z2L	Z2R	Z3L	Z3R

Surround

This unit is equipped with a digital signal processing circuit that lets you play program sources in the sound mode to achieve the same sense of presence as in a movie theater.

Sound modes and surround parameters

This table shows the speakers that can be used in each sound mode and the surround parameters adjustable in each sound mode.

Symbols in the table

- This indicates the audio output channels or surround parameters that can be set.
- ⊙ This indicates the audio output channels. The output channels depend on the settings of “Speaker Config.” ([page 142](#)).

Sound Mode (page 84)	Channel output							Dialog Enhancer (page 121)	Subwoofer Level (page 121)
	Front L/R	Center	Surround L/R	Surround back L/R	Front height L/R	Front wide L/R	Subwoofer		
DIRECT/PURE DIRECT (2 channel)*1	○						⊙*7		○*7
DIRECT/PURE DIRECT (Multi-channel)*1	○	⊙	⊙	⊙*2	⊙*2	⊙*2	⊙		○
DSD DIRECT (2 channel)*1	○						⊙*7		○*7
DSD DIRECT (Multi-channel)*1	○	⊙	⊙				⊙		○
EXTERNAL IN	○	⊙	⊙	⊙			⊙		○
STEREO	○						⊙	○	○
MULTI CH IN	○	⊙	⊙	⊙	⊙*4		⊙	○	○
DOLBY PRO LOGIC IIz	○	⊙	⊙	⊙	⊙		⊙	○	○
DOLBY PRO LOGIC IIx	○	⊙	⊙	⊙			⊙	○	○
DOLBY PRO LOGIC II	○	⊙	⊙				⊙	○	○
DOLBY PRO LOGIC IIx A-DSX	○	⊙	⊙	⊙	⊙*5	⊙*6	⊙	○	○
DOLBY PRO LOGIC II A-DSX	○	⊙	⊙		⊙*5	⊙*6	⊙	○	○
DTS NEO:X	○	⊙	⊙	⊙*3	⊙*3	⊙*3	⊙	○	○
Audyssey DSX®	○	⊙	⊙	⊙	⊙*5	⊙*6	⊙	○	○
DOLBY DIGITAL	○	⊙	⊙	⊙	⊙*4		⊙	○	○
DOLBY DIGITAL Plus	○	⊙	⊙	⊙*2	⊙*2	⊙*2	⊙	○	○
DOLBY TrueHD	○	⊙	⊙	⊙*2	⊙*2	⊙*2	⊙	○	○
DTS SURROUND	○	⊙	⊙	⊙	⊙*4		⊙	○	○
DTS 96/24	○	⊙	⊙	⊙	⊙*4		⊙	○	○
DTS-HD	○	⊙	⊙	⊙*2	⊙*2	⊙*2	⊙	○	○
DTS Express	○	⊙	⊙	⊙	⊙*4		⊙	○	○
MULTI CH STEREO	○	⊙	⊙	⊙*3	⊙*3	⊙*3	⊙	○	○
WIDE SCREEN	○	⊙	⊙	⊙*3	⊙*3	⊙*3	⊙	○	○
SUPER STADIUM	○	⊙	⊙	⊙*3	⊙*3	⊙*3	⊙	○	○
ROCK ARENA	○	⊙	⊙	⊙*3	⊙*3	⊙*3	⊙	○	○
JAZZ CLUB	○	⊙	⊙	⊙*3	⊙*3	⊙*3	⊙	○	○
CLASSIC CONCERT	○	⊙	⊙	⊙*3	⊙*3	⊙*3	⊙	○	○
MONO MOVIE	○	⊙	⊙	⊙*3	⊙*3	⊙*3	⊙	○	○
VIDEO GAME	○	⊙	⊙	⊙*3	⊙*3	⊙*3	⊙	○	○
MATRIX	○	⊙	⊙	⊙*3	⊙*3	⊙*3	⊙	○	○
VIRTUAL	○						⊙	○	○

- *1 During playback in PURE DIRECT mode, the surround parameters are the same as in DIRECT mode.
- *2 A signal for each channel contained in an input signal is output as audio.
- *3 You can select speakers to output audio on the “Speaker Select” ([page 123](#)) setting in the menu.
- *4 Audio is output from the front height speaker when the set sound mode name contains “+PLIIz”. For information on how to check the sound mode, see [page 84](#).
- *5 Audio is output from the front height speaker when “Audyssey DSX®” ([page 126](#)) in the menu is set to “Wides/Heights” or “Heights”.
- *6 Audio is output from the front wide speaker when “Audyssey DSX®” ([page 126](#)) in the menu is set to “Wides/Heights” or “Wides”.
- *7 Only when “Subwoofer Mode” is set to “LFE+Main” ([page 144](#)), sound is output from the subwoofer.

Sound Mode (page 84)	Surround Parameter (page 121)									
	Cinema EQ (page 121)	Loudness Management *10 (page 121)	Dynamic Compression *11 (page 121)	Bass Sync *12 (page 121)	Low Frequency Effects *12 (page 122)	Delay Time (page 122)	Effect Level (page 122)	Room Size (page 122)	Height Gain *13 (page 123)	Speaker Select (page 123)
DIRECT/PURE DIRECT (2 channel)*1		<input type="radio"/>	<input type="radio"/>							
DIRECT/PURE DIRECT (Multi-channel)*1		<input type="radio"/>	<input type="radio"/>		<input type="radio"/>					
DSD DIRECT (2 channel)*1										
DSD DIRECT (Multi-channel)*1					<input type="radio"/>					
EXTERNAL IN					<input type="radio"/>					
STEREO		<input type="radio"/>	<input type="radio"/>	<input type="radio"/>	<input type="radio"/>					
MULTI CH IN	<input type="radio"/> *8			<input type="radio"/>	<input type="radio"/>					
DOLBY PRO LOGIC IIz	<input type="radio"/>	<input type="radio"/>	<input type="radio"/>					<input type="radio"/>		
DOLBY PRO LOGIC IIx	<input type="radio"/> *9	<input type="radio"/>	<input type="radio"/>							
DOLBY PRO LOGIC II	<input type="radio"/> *9	<input type="radio"/>	<input type="radio"/>							
DOLBY PRO LOGIC IIx A-DSX	<input type="radio"/> *9	<input type="radio"/>	<input type="radio"/>							
DOLBY PRO LOGIC II A-DSX	<input type="radio"/> *9	<input type="radio"/>	<input type="radio"/>							
DTS NEO:X	<input type="radio"/> *9	<input type="radio"/>	<input type="radio"/>							<input type="radio"/>
Audyssey DSX®	<input type="radio"/>	<input type="radio"/>	<input type="radio"/>	<input type="radio"/>	<input type="radio"/>					
DOLBY DIGITAL	<input type="radio"/> *8		<input type="radio"/>	<input type="radio"/>	<input type="radio"/>			<input type="radio"/>		
DOLBY DIGITAL Plus	<input type="radio"/> *8		<input type="radio"/>	<input type="radio"/>	<input type="radio"/>			<input type="radio"/>		
DOLBY TrueHD	<input type="radio"/> *8	<input type="radio"/>	<input type="radio"/>	<input type="radio"/>	<input type="radio"/>			<input type="radio"/>		
DTS SURROUND	<input type="radio"/> *8		<input type="radio"/>	<input type="radio"/>	<input type="radio"/>			<input type="radio"/>		
DTS 96/24	<input type="radio"/> *8			<input type="radio"/>	<input type="radio"/>			<input type="radio"/>		
DTS-HD	<input type="radio"/> *8			<input type="radio"/>	<input type="radio"/>			<input type="radio"/>		
DTS Express	<input type="radio"/> *8			<input type="radio"/>	<input type="radio"/>			<input type="radio"/>		
MULTI CH STEREO		<input type="radio"/>	<input type="radio"/>	<input type="radio"/>	<input type="radio"/>					<input type="radio"/>
WIDE SCREEN		<input type="radio"/>	<input type="radio"/>	<input type="radio"/>	<input type="radio"/>		<input type="radio"/>			<input type="radio"/>
SUPER STADIUM		<input type="radio"/>	<input type="radio"/>	<input type="radio"/>	<input type="radio"/>		<input type="radio"/>	<input type="radio"/>		<input type="radio"/>
ROCK ARENA		<input type="radio"/>	<input type="radio"/>	<input type="radio"/>	<input type="radio"/>		<input type="radio"/>	<input type="radio"/>		<input type="radio"/>
JAZZ CLUB		<input type="radio"/>	<input type="radio"/>	<input type="radio"/>	<input type="radio"/>		<input type="radio"/>	<input type="radio"/>		<input type="radio"/>
CLASSIC CONCERT		<input type="radio"/>	<input type="radio"/>	<input type="radio"/>	<input type="radio"/>		<input type="radio"/>	<input type="radio"/>		<input type="radio"/>
MONO MOVIE		<input type="radio"/>	<input type="radio"/>	<input type="radio"/>	<input type="radio"/>		<input type="radio"/>	<input type="radio"/>		<input type="radio"/>
VIDEO GAME		<input type="radio"/>	<input type="radio"/>	<input type="radio"/>	<input type="radio"/>		<input type="radio"/>	<input type="radio"/>		<input type="radio"/>
MATRIX		<input type="radio"/>	<input type="radio"/>	<input type="radio"/>	<input type="radio"/>	<input type="radio"/>				<input type="radio"/>
VIRTUAL		<input type="radio"/>	<input type="radio"/>	<input type="radio"/>	<input type="radio"/>					

- *1 During playback in PURE DIRECT mode, the surround parameters are the same as in DIRECT mode.
- *8 This setting is unavailable when the set sound mode name contains "+PLII Music" or "+NEO:X Music". For information on how to check the sound mode, see [page 84](#).
- *9 This setting is possible when the sound mode is "Cinema" mode.
- *10 This item can be selected when a Dolby TrueHD signal is played.
- *11 This item can be selected when a Dolby Digital or DTS signal is played.
- *12 This item can be selected when a Dolby Digital or DTS signal or DVD-Audio is played.
- *13 This setting is available when the set sound mode name contains "+PLIIz". For information on how to check the sound mode, see [page 84](#).

Sound Mode (page 84)	Surround Parameter (page 121)				Tone *14 (page 123)	Audyssey (page 125)					Restorer *18 (page 124)
	PRO LOGIC II/IIx Music mode only			NEO:X mode only		MultEQ® XT 32 (page 125)	Dynamic EQ *17 (page 125)	Dynamic Volume *17 (page 126)	Audyssey LFC™ *17 (page 126)	Audyssey DSX® (page 126)	
	Panorama (page 122)	Dimension (page 122)	Center Width (page 122)	Center Gain (page 122)							
DIRECT/PURE DIRECT (2 channel)*1											
DIRECT/PURE DIRECT (Multi-channel)*1											
DSD DIRECT (2 channel)*1											
DSD DIRECT (Multi-channel)*1											
EXTERNAL IN											
STEREO					<input type="radio"/>	<input type="radio"/>	<input type="radio"/>	<input type="radio"/>	<input type="radio"/>	<input type="radio"/>	<input type="radio"/>
MULTI CH IN					<input type="radio"/>	<input type="radio"/>	<input type="radio"/>	<input type="radio"/>	<input type="radio"/>	<input type="radio"/>	<input type="radio"/>
DOLBY PRO LOGIC IIz					<input type="radio"/>	<input type="radio"/>	<input type="radio"/>	<input type="radio"/>	<input type="radio"/>	<input type="radio"/>	<input type="radio"/>
DOLBY PRO LOGIC IIx	<input type="radio"/>	<input type="radio"/>	<input type="radio"/>		<input type="radio"/>	<input type="radio"/>	<input type="radio"/>	<input type="radio"/>	<input type="radio"/>	<input type="radio"/>	<input type="radio"/>
DOLBY PRO LOGIC II	<input type="radio"/>	<input type="radio"/>	<input type="radio"/>		<input type="radio"/>	<input type="radio"/>	<input type="radio"/>	<input type="radio"/>	<input type="radio"/>	<input type="radio"/>	<input type="radio"/>
DOLBY PRO LOGIC IIx A-DSX	<input type="radio"/>	<input type="radio"/>	<input type="radio"/>		<input type="radio"/>	<input type="radio"/>	<input type="radio"/>	<input type="radio"/>	<input type="radio"/>	<input type="radio"/>	<input type="radio"/>
DOLBY PRO LOGIC II A-DSX	<input type="radio"/>	<input type="radio"/>	<input type="radio"/>		<input type="radio"/>	<input type="radio"/>	<input type="radio"/>	<input type="radio"/>	<input type="radio"/>	<input type="radio"/>	<input type="radio"/>
DTS NEO:X				<input type="radio"/>	<input type="radio"/>	<input type="radio"/>	<input type="radio"/>	<input type="radio"/>	<input type="radio"/>	<input type="radio"/>	<input type="radio"/>
Audyssey DSX®					<input type="radio"/>	<input type="radio"/>	<input type="radio"/>	<input type="radio"/>	<input type="radio"/>	<input type="radio"/>	<input type="radio"/>
DOLBY DIGITAL					<input type="radio"/>	<input type="radio"/>	<input type="radio"/>	<input type="radio"/>	<input type="radio"/>	<input type="radio"/>	<input type="radio"/>
DOLBY DIGITAL Plus					<input type="radio"/>	<input type="radio"/>	<input type="radio"/>	<input type="radio"/>	<input type="radio"/>	<input type="radio"/>	<input type="radio"/>
DOLBY TrueHD					<input type="radio"/>	<input type="radio"/>	<input type="radio"/>	<input type="radio"/>	<input type="radio"/>	<input type="radio"/>	<input type="radio"/>
DTS SURROUND					<input type="radio"/>	<input type="radio"/>	<input type="radio"/>	<input type="radio"/>	<input type="radio"/>	<input type="radio"/>	<input type="radio"/>
DTS 96/24					<input type="radio"/>	<input type="radio"/>	<input type="radio"/>	<input type="radio"/>	<input type="radio"/>	<input type="radio"/>	<input type="radio"/>
DTS-HD					<input type="radio"/>	<input type="radio"/>	<input type="radio"/>	<input type="radio"/>	<input type="radio"/>	<input type="radio"/>	<input type="radio"/>
DTS Express					<input type="radio"/>	<input type="radio"/>	<input type="radio"/>	<input type="radio"/>	<input type="radio"/>	<input type="radio"/>	<input type="radio"/>
MULTI CH STEREO					<input type="radio"/>	<input type="radio"/>	<input type="radio"/>	<input type="radio"/>	<input type="radio"/>	<input type="radio"/>	<input type="radio"/>
WIDE SCREEN					<input type="radio"/>	<input type="radio"/>	<input type="radio"/>	<input type="radio"/>	<input type="radio"/>	<input type="radio"/>	<input type="radio"/>
SUPER STADIUM					<input type="radio"/> *15	<input type="radio"/>	<input type="radio"/>	<input type="radio"/>	<input type="radio"/>	<input type="radio"/>	<input type="radio"/>
ROCK ARENA					<input type="radio"/> *16	<input type="radio"/>	<input type="radio"/>	<input type="radio"/>	<input type="radio"/>	<input type="radio"/>	<input type="radio"/>
JAZZ CLUB					<input type="radio"/>	<input type="radio"/>	<input type="radio"/>	<input type="radio"/>	<input type="radio"/>	<input type="radio"/>	<input type="radio"/>
CLASSIC CONCERT					<input type="radio"/>	<input type="radio"/>	<input type="radio"/>	<input type="radio"/>	<input type="radio"/>	<input type="radio"/>	<input type="radio"/>
MONO MOVIE					<input type="radio"/>	<input type="radio"/>	<input type="radio"/>	<input type="radio"/>	<input type="radio"/>	<input type="radio"/>	<input type="radio"/>
VIDEO GAME					<input type="radio"/>	<input type="radio"/>	<input type="radio"/>	<input type="radio"/>	<input type="radio"/>	<input type="radio"/>	<input type="radio"/>
MATRIX					<input type="radio"/>	<input type="radio"/>	<input type="radio"/>	<input type="radio"/>	<input type="radio"/>	<input type="radio"/>	<input type="radio"/>
VIRTUAL					<input type="radio"/>	<input type="radio"/>	<input type="radio"/>	<input type="radio"/>	<input type="radio"/>	<input type="radio"/>	<input type="radio"/>

- *1 During playback in PURE DIRECT mode, the surround parameters are the same as in DIRECT mode.
- *14 This item cannot be set when “Dynamic EQ” (page 125) is set to “On”.
- *15 In this sound mode, bass is +6 dB, and treble is 0 dB (Default).
- *16 In this sound mode, bass is +6 dB, and treble is +4 dB (Default).
- *17 This item cannot be set when “MultEQ® XT 32” (page 125) is set to “Off” or “Graphic EQ”.
- *18 This item can be set when the input signal is analog, PCM 48 kHz or 44.1 kHz.

Types of input signals, and corresponding sound modes

This table shows the input signal that can be played in each sound mode. Check the audio signal of the input source then select the sound mode.

Symbols in the table

- This indicates the default sound mode.
- This indicates the selectable sound mode.

Sound Mode (page 84)	NOTE	Input signal types and formats																	
		ANALOG	PCM		DTS-HD		DTS					DOLBY		DOLBY DIGITAL				Super Audio CD	
			PCM (multi ch)	PCM (2ch)	DTS-HD Master Audio	DTS-HD High Resolution Audio	DTS EXPRESS	DTS ES DSCRT (With Flag)	DTS ES MTRX (With Flag)	DTS (5.1ch)	DTS 96/24	DOLBY TrueHD	DOLBY DIGITAL Plus	DOLBY DIGITAL EX (With Flag)	DOLBY DIGITAL EX (With no Flag)	DOLBY DIGITAL (5.1ch)	DOLBY DIGITAL (2ch)	DSD (multi ch)	DSD (2ch)
DTS SURROUND																			
DTS-HD MSTR	*1			●															
DTS-HD HI RES	*1				●														
DTS ES DSCRT6.1	*2						●												
DTS ES MTRX6.1	*2							●											
DTS SURROUND	*1							○	○	●									
DTS 96/24	*1										●								
DTS (-HD) + PLIIx Cinema	*3			○	○	○				○	○								
DTS (-HD) + PLIIx Music	*2			○	○	○				○	○								
DTS (-HD) + PLIIz	*4			○	○	○			○	○	○								
DTS EXPRESS	*1					●													
DTS (-HD) + NEO:X Cinema				○	○	○			○	○	○								
DTS (-HD) + NEO:X Music				○	○	○			○	○	○								
DTS (-HD) + NEO:X Game				○	○	○			○	○	○								
DTS NEO:X Cinema	*1	○		○															○
DTS NEO:X Music	*1	○		○															○
DTS NEO:X Game	*1	○		○															○
Audyssey DSX®				○	○	○	○	○	○	○	○								

- *1 If "Audyssey DSX®" (page 126) is set to "Wides/Heights", "Heights" or "Wides", the Audyssey DSX® effect is added to the sound mode marked with *1.
- *2 If "Speaker Config." - "Surr. Back" (page 142) is set to "None", this sound mode cannot be selected.
- *3 If "Speaker Config." - "Surr. Back" (page 142) is set to "1spkr" or "None", this sound mode cannot be selected.
- *4 If "Speaker Config." - "Front Height" (page 142) is set to "None", this sound mode cannot be selected.

Sound Mode (page 84)	NOTE	Input signal types and formats																		
		ANALOG	PCM		DTS-HD		DTS					DOLBY		DOLBY DIGITAL				Super Audio CD		
			PCM (multi ch)	PCM (2ch)	DTS-HD Master Audio	DTS-HD High Resolution Audio	DTS EXPRESS	DTS ES DSCRT (With Flag)	DTS ES MTRX (With Flag)	DTS (5.1ch)	DTS 96/24	DOLBY TrueHD	DOLBY DIGITAL Plus	DOLBY DIGITAL EX (With Flag)	DOLBY DIGITAL EX (With no Flag)	DOLBY DIGITAL (5.1ch)	DOLBY DIGITAL (2ch)	DSD (multi ch)	DSD (2ch)	
DOLBY SURROUND																				
DOLBY TrueHD	*1												●							
DOLBY DIGITAL+	*1												●							
DOLBY DIGITAL EX	*2														○	○	○			
DOLBY (D+) (HD) +EX	*2												○	○						
DOLBY DIGITAL	*1														●	●	●			
DOLBY (D) (D+) (HD) + PLIIx Cinema	*3												○	○	○	○	○			
DOLBY (D) (D+) (HD) + PLIIx Music	*2												○	○	○	○	○			
DOLBY (D) (D+) (HD) + PLIIz	*4												○	○	○	○	○			
DOLBY (D) (D+) (HD) + NEO:X Cinema													○	○	○	○	○			
DOLBY (D) (D+) (HD) + NEO:X Music													○	○	○	○	○			
DOLBY (D) (D+) (HD) + NEO:X Game													○	○	○	○	○			
DOLBY PRO LOGIC IIx Cinema	*2	○		○														○		○
DOLBY PRO LOGIC IIx Music	*2	○		○														○		○
DOLBY PRO LOGIC IIx Game	*2	○		○														○		○
DOLBY PRO LOGIC IIx Cinema A-DSX		○		○														○		
DOLBY PRO LOGIC IIx Music A-DSX		○		○														○		
DOLBY PRO LOGIC IIx Game A-DSX		○		○														○		
DOLBY PRO LOGIC IIz	*4	○		○														○		○
DOLBY PRO LOGIC II Cinema	*1	○		○														○		○
DOLBY PRO LOGIC II Music	*1	○		○														○		○
DOLBY PRO LOGIC II Game	*1	○		○														○		○
DOLBY PRO LOGIC II CINEMA A-DSX		○		○														○		
DOLBY PRO LOGIC II MUSIC A-DSX		○		○														○		
DOLBY PRO LOGIC II GAME A-DSX		○		○														○		
Audyssey DSX®													○	○	○	○	○			

- *1 If "Audyssey DSX®" (page 126) is set to "Wides/Heights", "Heights" or "Wides", the Audyssey DSX® effect is added to the sound mode marked with *1.
- *2 If "Speaker Config." - "Surr. Back" (page 142) is set to "None", this sound mode cannot be selected.
- *3 If "Speaker Config." - "Surr. Back" (page 142) is set to "1spkr" or "None", this sound mode cannot be selected.
- *4 If "Speaker Config." - "Front Height" (page 142) is set to "None", this sound mode cannot be selected.

Sound Mode (🔗 page 84)	NOTE	Input signal types and formats																			
		ANALOG	PCM		DTS-HD		DTS					DOLBY		DOLBY DIGITAL				Super Audio CD			
			PCM (multi ch)	PCM (2ch)	DTS-HD Master Audio	DTS-HD High Resolution Audio	DTS EXPRESS	DTS ES DSCRT (With Flag)	DTS ES MTRX (With Flag)	DTS (5.1ch)	DTS 96/24	DOLBY TrueHD	DOLBY DIGITAL Plus	DOLBY DIGITAL EX (With Flag)	DOLBY DIGITAL EX (With no Flag)	DOLBY DIGITAL (5.1ch)	DOLBY DIGITAL (2ch)	DSD (multi ch)	DSD (2ch)		
MULTI CH IN																					
MULTI CH IN	*1		●																○		
MULTI CH IN + PLIIx Cinema	*3		○																○		
MULTI CH IN + PLIIx Music	*2		○																○		
MULTI CH IN + PLIIz	*4		○																○		
MULTI CH IN + NEO:X Cinema			○																		
MULTI CH IN + NEO:X Music			○																		
MULTI CH IN + NEO:X Game			○																		
MULTI CH IN + Dolby EX	*2		○																○		
MULTI CH IN 7.1	*2		● (7.1)																		
Audyssey DSX®			○																○		
DIRECT																					
DIRECT		○	○	○	○	○	○	○	○	○	○	○	○	○	○	○	○	○	○	○	○
PURE DIRECT																					
PURE DIRECT		○	○	○	○	○	○	○	○	○	○	○	○	○	○	○	○	○	○	○	○
DSP SIMULATION																					
MULTI CH STEREO		○	○	○	○	○	○	○	○	○	○	○	○	○	○	○	○	○	○	○	○
WIDE SCREEN		○	○	○	○	○	○	○	○	○	○	○	○	○	○	○	○	○	○	○	○
SUPER STADIUM		○	○	○	○	○	○	○	○	○	○	○	○	○	○	○	○	○	○	○	○
ROCK ARENA		○	○	○	○	○	○	○	○	○	○	○	○	○	○	○	○	○	○	○	○
JAZZ CLUB		○	○	○	○	○	○	○	○	○	○	○	○	○	○	○	○	○	○	○	○
CLASSIC CONCERT		○	○	○	○	○	○	○	○	○	○	○	○	○	○	○	○	○	○	○	○
MONO MOVIE		○	○	○	○	○	○	○	○	○	○	○	○	○	○	○	○	○	○	○	○
VIDEO GAME		○	○	○	○	○	○	○	○	○	○	○	○	○	○	○	○	○	○	○	○
MATRIX		○	○	○	○	○	○	○	○	○	○	○	○	○	○	○	○	○	○	○	○
VIRTUAL		○	○	○	○	○	○	○	○	○	○	○	○	○	○	○	○	○	○	○	○
STEREO																					
STEREO		●	○	●	○	○	○	○	○	○	○	○	○	○	○	○	○	○	○	○	○

- *1 If "Audyssey DSX®" (🔗 page 126) is set to "Wides/Heights", "Heights" or "Wides", the Audyssey DSX® effect is added to the sound mode marked with *1.
- *2 If "Speaker Config." - "Surr. Back" (🔗 page 142) is set to "None", this sound mode cannot be selected.
- *3 If "Speaker Config." - "Surr. Back" (🔗 page 142) is set to "1spkr" or "None", this sound mode cannot be selected.
- *4 If "Speaker Config." - "Front Height" (🔗 page 142) is set to "None", this sound mode cannot be selected.

Relationship between video signals and monitor output

MAIN ZONE MONITOR OUT											
Video Conversion	Input connector			Output connector			Menu displayed				
	HDMI	COMPONENT	VIDEO	HDMI	COMPONENT	VIDEO	HDMI	COMPONENT	VIDEO		
On	×	×	×	×	×	×	Only the menu is displayed				
On	×	×	○	○ <VIDEO>	○ <VIDEO>	○ <VIDEO>	○ (VIDEO)	○ (VIDEO)	○ (VIDEO)		
On	×	○ (1080p)	×	○ <COMPONENT>	○ <COMPONENT>	×	○ (COMPONENT)	×	×		
On	×	○ (480p – 720p)	×			○ <COMPONENT>		○ (COMPONENT)	○ (COMPONENT)	○ (COMPONENT)	
On	×	○ (480i/576i)	×			○ <VIDEO>		×	×	×	
On	×	○ (1080p)	○			○ <VIDEO>		×	○ (VIDEO)	○ (VIDEO)	
On*1	×	○ (1080p)	○			×		○ (COMPONENT)	○ (COMPONENT)	×	
On	×	○ (480p – 720p)	○			○ <COMPONENT>		○ <COMPONENT>	○ (COMPONENT)	○ (COMPONENT)	
On	×	○ (480i/576i)	○	○ <HDMI>	×	×	○ (HDMI)	×	×		
On	○	×	○			○ <VIDEO>		×	×	×	
On	○	○	×			×		×	×	×	
On	○	○	○			○ <COMPONENT>		×	×	×	
On	○	○	○			×		×	×	×	
On	○	○	○			○ <COMPONENT>		×	×	×	
On*3	×	×	○	○ <VIDEO>	×	○ <VIDEO>	○ (VIDEO)	×	×		
On*3	×	○ (1080p)	×	○ <COMPONENT>	○ <COMPONENT>	×	○ (COMPONENT)	×	×		
On*3	×	○ (480p – 720p)	×			×				×	
On*3	×	○ (480i/576i)	×			×				×	
On*3	×	○ (1080p)	○			○ <VIDEO>				×	
On*3	×	○ (480p – 720p)	○			×				×	
On*3	×	○ (480i/576i)	○			×				×	
Off	×	×	×	×	×	×	Only the menu is displayed				
Off	×	×	○			○ <VIDEO>					
Off	×	○	×			×					
Off	×	○	○			○ <COMPONENT>				○ <VIDEO>	
Off	○	×	×			×				×	
Off	○	×	○			×				○ <VIDEO>	
Off	○	○	×	○ <HDMI>	×	×					
Off	○	○	×			×				×	
Off	○	○	○			×				×	
Off	○	○	○			○ <COMPONENT>				○ <VIDEO>	
Off	○	○	○			×				×	
Off	○	○	○			○ <COMPONENT>				○ <VIDEO>	

○ : Video signal input present

×

*1 When no HDMI monitor is connected or the HDMI monitor's power is not on.

*2 Only the menu is displayed when no HDMI monitor is connected or the HDMI monitor's power is not on.

*3 When "Resolution" (page 131) is set to "4K" for outputting analog video input signals from the HDMI connector.

○ <>: The input signal between the < > marks is output.

×

: No video signal output

○ () : Superimposed on the picture indicated in ().

×

() : Only the picture in () is output.

×

: Neither the picture nor the menu is output.

ZONE MONITOR OUT					
Input connector			Output connector		
HDMI	COMPONENT	VIDEO	HDMI ZONE4	COMPONENT (ZONE2)	VIDEO (ZONE2)
×	×	×	×	×	×
×	×	○		○ <VIDEO>	
×	○	×		×	
×	○	○		○ <VIDEO>	
○	×	×	○ <HDMI>	×	×
○	×	○		○ <VIDEO>	
○	○	×		×	
○	○	○		○ <VIDEO>	
				○ <COMPONENT>	×
				○ <COMPONENT>	○ <VIDEO>

○ : Video signal input present
 × : No video signal input

○ <>: The input signal between the < > marks is output.
 × : No video signal output



The main zone video conversion function is compatible with the following formats: NTSC, PAL, SECAM, NTSC4.43, PAL-N, PAL-M and PAL-60.

NOTE

- The status display screen cannot be displayed at a computer’s resolution (e.g. VGA) or while certain 3D video contents is being played.
- When the menu is operated on a computer’s resolution (e.g. VGA) or during playback of certain 3D video content, the playback image switches to the menu screen image.

Video signal resolution conversion table

When “Video Conversion” (page 131) is set to “On”, “i/p Scaler” (page 131) is set to “Analog”, “Analog & HDMI” or “HDMI” are set, the resolution of the input video signal can be converted to a different resolution for output (page 7 “Converting input video signals for output (Video conversion function)”).

The relationship between the resolution of the convertible video signal and HDMI output resolution is shown in the table below.

	Input resolution	Output resolution	HDMI Output						
			480i/576i *1	480p/576p	1080i	720p	1080p	1080p 24Hz	4K *2
Video input	480i/576i		○	○	○	○	○	○	○
Component video input	480i/576i		○	○	○	○	○	○	○*5
	480p/576p		-	○	○	○	○	○	○*5
	1080i		-	-	○	○	○	○	○*5
	720p		-	-	○	○	○	○	○*5
	1080p		-	-	-	-	○	○	○*5
HDMI input	480i/576i		○	○	○	○	○	○	○
	480p/576p		-	○	○	○	○	○	○
	1080i		-	-	○	○	○	○	○
	720p		-	-	○	○	○	○	○
	1080p 24Hz		-	-	-	-	○*3	○*4	○
	1080p		-	-	-	-	○	○	○
	4K		-	-	-	-	-	-	○*6

○ The resolution set in “Resolution” (page 132) in the menu is output.

- Output at the same resolution as the input video signal resolution.

*1 Only output when “i/p Scaler” in the menu is set to “Off”.

*2 Output at a resolution of 3840 x 2160 (24/25/30Hz).

*3 The resolution set in “Resolution” (page 132) in the menu is set to “Auto”, and a television that does not support 1080p 24Hz video signals is connected.

*4 The resolution set in “Resolution” (page 132) in the menu is set to “Auto”, and a television that supports 1080p 24Hz video signals is connected.

*5 While signals are being upscaled to 4K, the menu screen is only displayed on a TV that is connected to this unit via HDMI.

*6 Output at the same resolution as the input video signal resolution.

NOTE

- Component video and video output are output at the same resolution as the input video signal resolution.
- The 4K, 3D, Computer resolution, “x.v.Color”, sYCC601 color, Adobe RGB color or Adobe YCC601 color input to HDMI is output at the same resolution as the input video signal.
- When “Video Mode” in the menu is set to “Game” or “Auto” and game contents are played, the same resolution as the input video signal is output.
- When “Resolution” in the menu is set to “Auto”, the number of pixels in the television panel connected to the HDMI output connector is automatically detected, and the optimum resolution is output according to the table above.
- If 1080p 24Hz signals input from the HDMI terminal are converted into 1080p 60Hz/1080p 50Hz for output, they are output according to the specified “Format” (page 133) setting in the menu:
 - “NTSC” – Output as 1080p 60Hz.
 - “PAL” – Output as 1080p 50Hz.
- You can not convert 60Hz into 50Hz or vice versa.
- You can not convert 50Hz into 24Hz.
- This item does not support the HDMI ZONE4 function.

Explanation of terms

A

Adobe RGB color, Adobe YCC601 color

The color space defined by Adobe Systems Inc. Because it is a wider color space than RGB, it can produce more vivid and natural images.

AirPlay

AirPlay sends (plays) contents recorded in iTunes or on an iPhone/iPod touch/iPad to a compatible device via the network.

AL32 Processing Multi Channel

AL32 Processing for All Channels

DENON has further developed its proprietary AL32 Processing, an analog waveform reproduction technology, to support the 192 kHz sampling frequency. AL32 Processing, thoroughly suppresses quantization noise associated with D/A conversion to reproduce the low-level signals with optimum clarity that will bring out all the delicate nuances of the music.

App Store

App Store is a site that sells application software for such devices as the iPhone or iPod Touch, and is operated by Apple Inc.

Audyssey Dynamic EQ®

Dynamic EQ solves the problem of deteriorating sound quality as volume is decreased by taking into account human perception and room acoustics. Audyssey Dynamic EQ® works in tandem with Audyssey MultEQ® XT 32 to provide well-balanced sound for every listener at any volume level.

Audyssey Dynamic Surround Expansion (A-DSX)

Audyssey DSX® is a scalable system that adds new speakers to improve surround impression. Starting with a 5.1 system Audyssey DSX® first adds Wide channels for the biggest impact on envelopment. Research in human hearing has proven that information from the Wide channels is much more critical in the presentation of a realistic soundstage than the Back Surround channels found in traditional 7.1 systems. Audyssey DSX® then creates a pair of Height channels to reproduce the next most important acoustical and perceptual cues. In addition to these new Wide and Height channels, Audyssey DSX® applies Surround Envelopment Processing to enhance the blend between the front and surround channels.

Audyssey Dynamic Volume®

Dynamic Volume solves the problem of large variations in volume level between television programs, commercials, and between the soft and loud passages of movies. Audyssey Dynamic EQ® is integrated into Dynamic Volume so that as the playback volume is adjusted automatically, the perceived bass response, tonal balance, surround impression, and dialog clarity remain the same.

Audyssey LFC™ (Low Frequency Containment)

Audyssey LFC™ solves the problem of low frequency sounds disturbing people in neighboring rooms or apartments. Audyssey researchers found the range of frequencies that most readily penetrate wood and cement construction typical of homes and apartments and then created a technology to contain them. Audyssey LFC™ dynamically monitors the audio content and removes the low frequencies able to pass through walls, floors and ceilings. Audyssey LFC™ then applies psychoacoustic processing to restore the perception of low bass for listeners in the room. The result is great sound that no longer disturbs the neighbors.

Audyssey MultEQ® XT 32

MultEQ® XT 32 is a room equalization solution that calibrates any audio system so that it can achieve optimum performance for every listener in a large listening area. Based on several room measurements, MultEQ® XT 32 calculates an equalization solution that corrects for both time and frequency response problems in the listening area and also performs a fully automated surround system setup.

Auto Lip Sync

If you connect the unit to a TV that supports the Auto Lip Sync function, it can automatically correct delay between the audio and video.

B

Bass Sync

Audio sources such as BD and DVD inherently have time delay between the bass components of the satellite channel and the LFE channel. This function adjusts such a delay for reproducing (replaying) richer bass sound during playback. This function is by default set to 0 msec. Since the delay varies according to the title, play back the audio source and adjust to the most effective value for playback. For some audio sources that are played back, this function may have little effect.

D

Deep Color

An imaging technology supported by HDMI. Unlike RGB, which uses 8 bits (256 shades) per color, it can use 10 bits (1024 shades), 12 bits (4096 shades), or 16 bits (65536 shades) to produce colors in higher definition.

Both devices linked via HDMI must support Deep Color.

Denon Link HD

Denon Link HD uses the clock of the AV amplifier connected by Denon Link HD to achieve HDMI signal transfer with low jitter.

DLNA

DLNA and DLNA CERTIFIED are trademarks and/or service marks of Digital Living Network Alliance. Some contents may not be compatible with other DLNA CERTIFIED® products.

Dolby Digital

Dolby Digital is a multi-channel digital signal format developed by Dolby Laboratories.

A total of 5.1 channels are played: 3 front channels ("FL", "FR" and "C"), 2 surround channels ("SL" and "SR") and the "LFE" channel for low frequencies.

Because of this, there is no crosstalk between channels and a realistic sound field with a "three-dimensional" feeling (sense of distance, movement and positioning) is achieved.

A realistic, powerful sense of presence is achieved when playing movie sources in AV rooms as well.

Dolby Digital EX

Dolby Digital EX is a 6.1-channel surround format proposed by Dolby Laboratories that allows users to enjoy in their homes the "DOLBY DIGITAL SURROUND EX" audio format jointly developed by Dolby Laboratories and Lucas Films.

The 6.1 channels of sound, including surround back channels, provide improved sound positioning and expression of space.

Dolby Digital Plus

Dolby Digital Plus is an improved Dolby Digital signal format that is compatible with up to 7.1 channels of discrete digital sound and also improves sound quality thanks to extra data bit rate performance. It is upwardly compatible with conventional Dolby Digital, so it offers greater flexibility in response to the source signal and the conditions of the playback device.

Dolby Pro Logic II

Dolby Pro Logic II is a matrix decoding technology developed by Dolby Laboratories.

Regular music such as that on CDs is encoded into 5 channels to achieve an excellent surround effect. The surround channel signals are converted into stereo and full band signals (with a frequency response of 20 Hz to 20 kHz or greater) to create a "three-dimensional" sound image offering a rich sense of presence for all stereo sources.

Dolby Pro Logic IIx

Dolby Pro Logic IIx is a further improved version of the Dolby Pro Logic II matrix decoding technology. Audio signals recorded in 2 channels are decoded to achieve a natural sound with up to 7.1 channels. There are three modes: "Music" suited for playing music, "Cinema" suited for playing movies, and "Game" which is optimized for playing games.

Dolby Pro Logic IIz

Dolby Pro Logic IIz introduces a new dimension to Home Entertainment through the addition of a pair of front height channels. Compatible with stereo, 5.1-channel and 7.1-channel content, Dolby Pro Logic IIz provides enhanced spaciousness, depth and dimension to movies, concert video and video game playback while maintaining the full integrity of the source mix.

Dolby Pro Logic IIz identifies and decodes spatial cues that occur naturally in all content, directing this information to the front height channels, complementing the performance of left and right surround sound speakers. Content that is encoded with Dolby Pro Logic IIz height channel information can be even more revealing, with perceptually discrete height channel information bringing an exciting new dimension to home entertainment.

Dolby Pro Logic IIz, with front height channels is also an ideal alternative for households that cannot support the placement of back surround speakers of a typical 7.1-channel system but may have bookshelf space available to support the addition of height speakers.

Dolby TrueHD

Dolby TrueHD is a high definition audio technology developed by Dolby Laboratories, using lossless coding technology to faithfully reproduce the sound of the studio master.

This format provides the facility to support up to 8 audio channels with a sampling frequency of 96 kHz/24 bit resolution and up to 6 audio channels with a sampling frequency of 192 kHz/24 bit resolution. Dolby TrueHD is adopted for applications that put very high importance on sound quality.

Downmix

This function converts the number of channels of surround audio to less number of channels and plays back.

DTS

This is an abbreviation of Digital Theater System, which is a digital audio system developed by DTS. When playing back audio by connecting this system with a device such as DTS amplifier, accurate sound field position and realistic sound effect as if you are in a movie theater can be obtained.

DTS 96/24

DTS 96/24 is a digital audio format enabling high sound quality playback in 5.1 channels with a sampling frequency of 96 kHz and 24 bit quantization on DVD-Video.

DTS Digital Surround

DTS Digital Surround is the standard digital surround format of DTS, Inc., compatible with a sampling frequency of 44.1 or 48 kHz and up to 5.1 channels of digital discrete surround sound.

DTS-ES™ Discrete 6.1

DTS-ES™ Discrete 6.1 is a 6.1-channel discrete digital audio format adding a surround back (SB) channel to the DTS digital surround sound.

Decoding of conventional 5.1-channel audio signals is also possible according to the decoder.

DTS-ES™ Matrix 6.1

DTS-ES™ Matrix 6.1 is a 6.1-channel discrete digital audio format inserting a surround back (SB) channel to the DTS digital surround sound through matrix encoding. Decoding of conventional 5.1-channel audio signals is also possible according to the decoder.

DTS Express

DTS Express is an audio format supporting low bit rates (max. 5.1 channels, 24 to 256 kbps).

DTS-HD

This audio technology provides higher sound quality and enhanced functionality than the conventional DTS and is adopted as an optional audio for Blu-ray Disc. This technology supports multi-channel, high data transfer speed, high sampling frequency, and lossless audio playback. Maximum 7.1-channels are supported in Blu-ray Disc.

DTS-HD High Resolution Audio

DTS-HD High Resolution Audio is an improved version of the conventional DTS, DTS-ES and DTS 96/24 signals formats, compatible with sampling frequencies of 96 or 48 kHz and up to 7.1 channels of discrete digital sound. High data bit rate performance provides high quality sound. This format is fully compatible with conventional products, including conventional DTS digital surround 5.1-channel data.

DTS-HD Master Audio

DTS-HD Master Audio is a lossless audio format created by Digital Theater System (DTS). This format provides the facility to support up to 8 audio channels with a sampling frequency of 96 kHz/24 bit resolution and up to 6 audio channels with a sampling frequency of 192 kHz/24 bit resolution. It is fully compatible with conventional products, including conventional DTS digital surround 5.1-channel data.

DTS Neo:X

This matrix decoding technology uses the DTS NEO:X decoder to playback 2-channel source or 5.1/6.1/7.1 channel surround sources as a maximum of 11.1 channel surround sound. There are 3 modes: "Music" suited for playing music, "Cinema" suited for playing movies, and "Game" which is optimized for playing games.

Dynamic range

The difference between the maximum undistorted sound level and the minimum discernible level above the noise emitted by the device.

F**FLAC**

FLAC stands for Free lossless Audio Codec, and is a lossless free audio file format. Lossless means that the audio is compressed without any loss in quality. The FLAC license is as shown below.

Copyright (C) 2000,2001,2002,2003,2004,2005,2006,2007,2008,2009 Josh Coalsen

Redistribution and use in source and binary forms, with or without modification, are permitted provided that the following conditions are met:

- Redistributions of source code must retain the above copyright notice, this list of conditions and the following disclaimer.
 - Redistributions in binary form must reproduce the above copyright notice, this list of conditions and the following disclaimer in the documentation and/or other materials provided with the distribution.
 - Neither the name of the Xiph.org Foundation nor the names of its contributors may be used to endorse or promote products derived from this software without specific prior written permission.
- THIS SOFTWARE IS PROVIDED BY THE COPYRIGHT HOLDERS AND CONTRIBUTORS "AS IS" AND ANY EXPRESS OR IMPLIED WARRANTIES, INCLUDING, BUT NOT LIMITED TO, THE IMPLIED WARRANTIES OF MERCHANTABILITY AND FITNESS FOR A PARTICULAR PURPOSE ARE DISCLAIMED. IN NO EVENT SHALL THE FOUNDATION OR CONTRIBUTORS BE LIABLE FOR ANY DIRECT, INDIRECT, INCIDENTAL, SPECIAL, EXEMPLARY, OR CONSEQUENTIAL DAMAGES (INCLUDING, BUT NOT LIMITED TO, PROCUREMENT OF SUBSTITUTE GOODS OR SERVICES; LOSS OF USE, DATA, OR PROFITS; OR BUSINESS INTERRUPTION) HOWEVER CAUSED AND ON ANY THEORY OF LIABILITY, WHETHER IN CONTRACT, STRICT LIABILITY, OR TORT (INCLUDING NEGLIGENCE OR OTHERWISE) ARISING IN ANY WAY OUT OF THE USE OF THIS SOFTWARE, EVEN IF ADVISED OF THE POSSIBILITY OF SUCH DAMAGE.

H**HDCP**

When transmitting digital signals between devices, this copyright protection technology encrypts the signals to prevent content from being copied without authorization.

HDMI

This is an abbreviation of High-Definition Multimedia Interface, which is an AV digital interface that can be connected to a TV or amplifier. Video signal and audio signal can be connected using 1 cable.

I**iTunes**

iTunes is the name of the multimedia player provided by Apple Inc. It enables management and playback of multimedia contents including music and movies. iTunes supports many main file formats including AAC, WAV, and MP3.

L**LFE**

This is an abbreviation of Low Frequency Effect, which is an output channel that emphasizes low frequency effect sound. Surround audio is intensified by outputting 20 Hz to 120 Hz deep bass.

M**MAIN ZONE**

The room where this unit is placed is called the MAIN ZONE .

MP3 (MPEG Audio Layer-3)

This is an internationally standardized audio data compression scheme, using the "MPEG-1" video compression standard. It compresses the data volume to about one eleventh its original size while maintaining sound quality equivalent to a music CD.

MPEG (Moving Picture Experts Group), MPEG-2, MPEG-4

These are the names for digital compression format standards used for the encoding of video and audio. Video standards include "MPEG-1 Video", "MPEG-2 Video", "MPEG-4 Visual", "MPEG-4 AVC". Audio standards include "MPEG-1 Audio", "MPEG-2 Audio", "MPEG-4 AAC".

P**Progressive (sequential scanning)**

This is a scanning system of video signal that displays 1 frame of video as one image. Compared to the interlace system, this system provides images with less flickering and bleeding.

Protection Circuit

This is a function to prevent damage to devices within the power supply when an abnormality such as an overload, excess voltage occurs or temperature for any reason.

In this unit, the power indicator blinks and the unit enters standby mode when an abnormality occurs.

S**Sampling frequency**

Sampling involves taking a reading of a sound wave (analog signal) at regular intervals and expressing the height of the wave at each reading in digitized format (producing a digital signal).

The number of readings taken in one second is called the "sampling frequency". The larger the value, the closer the reproduced sound is to the original.

Speaker impedance

This is an AC resistance value, indicated in Ω (ohms). Greater power can be obtained with this value smaller.

sYCC601 color

Like "x.v.Color", each of these color spaces defines a palette of available colors that is larger than the traditional RGB color model.

V**vTuner**

This is a free online content server for Internet Radio. Note that usage fees are included in upgrade costs.

For inquiries about this service, visit the vTuner site below.

vTuner website: <http://www.radiodenon.com>

This product is protected by certain intellectual property rights of Nothing Else Matters Software and BridgeCo. Use or distribution of such technology outside of this product is prohibited without a license from Nothing Else Matters Software and BridgeCo or an authorized subsidiary.

W**Windows Media DRM**

This is a copyright protection technology developed by Microsoft.

Content providers are using the digital rights management technology for Windows Media contained in this device (WM-DRM) to protect the integrity of their content (Secure Content) so that their intellectual property, including copyright, in such content is not misappropriated. This device uses WM-DRM software to play Secure Content (WM-DRM Software). If the security of the WM-DRM Software in this device has been compromised, owners of Secure Content (Secure Content Owners) may request that Microsoft revoke the WM-DRM Software's right to acquire new licenses to copy, display and/or play Secure Content. Revocation does not alter the WM-DRM Software's ability to play unprotected content. A list of revoked WM-DRM Software is sent to your device whenever you download a license for Secure Content from the Internet or from a PC. Microsoft may, in conjunction with such license, also download revocation list onto your device on behalf of Secure Content Owners.

Windows Media Player Ver.11 or later

This is a media player distributed free of charge by Microsoft Corporation.

It can play playlists created with Ver.11 or later of Windows Media Player, as well as WMA, DRM WMA, WAV, and other files.

WMA (Windows Media Audio)

This is audio compression technology developed by Microsoft Corporation.

WMA data can be encoded using Windows Media® Player Ver.7, 7.1, Windows Media® Player for Windows® XP and Windows Media® Player 9 Series.

To encode WMA files, only use applications authorized by Microsoft Corporation. If you use an unauthorized application, the file may not work properly.

X**x.v.Color**

This function lets HDTVs display colors more accurately. It enables display with natural, vivid colors. "x.v.Color" is trademark of Sony Corporation.

Z**ZONE2**

This unit can operate in a room other than the room where this unit is placed (MAIN ZONE) (ZONE2 playback). The room for ZONE2 playback is called ZONE2.

ZONE3

This unit can operate in a room other than the room where this unit is placed (MAIN ZONE) (ZONE3 playback). The room for ZONE3 playback is called ZONE3.

ZONE4

This unit can operate in a room other than the room where this unit is placed (MAIN ZONE) (ZONE4 playback). The room for ZONE4 playback is called ZONE4.

Troubleshooting

If a problem should arise, first check the following:

1. Are the connections correct?

2. Is the set being operated as described in the owner's manual?

3. Are the other devices operating properly?

If this unit does not operate properly, check the items listed in the table below. Should the problem persist, there may be a malfunction.

In this case, disconnect the power immediately and contact your store of purchase.

[General]

Symptom	Cause/Solution	Page
Power does not turn on.	<ul style="list-style-type: none"> Check whether the power plug is correctly inserted into the power outlet. The protection circuit is active. Disconnect the power plug from the electric outlet, wait 5 to 10 seconds and then insert it back into the outlet. 	32 195
Power automatically switches to standby mode.	<ul style="list-style-type: none"> The sleep timer is set. Turn on the power again, or change the sleep timer settings. "Auto Standby" is triggered when there is no operation for a set amount of time. To disable "Auto Standby", set "Auto Standby" on the menu to "Off". 	105, 113 153
Display is off.	<ul style="list-style-type: none"> Set "Dimmer" on the menu to something other than "Off". 	153
The power indicator is blinking red in intervals of approximately 2 seconds.	<ul style="list-style-type: none"> Due to the temperature rise within this unit, the protection circuit is working. Please turn off power once, and re-apply the power after the temperature has fallen sufficiently. Please re-install this unit in a place having good ventilation. 	195 -
The power indicator is blinking red in intervals of approximately 0.5 seconds.	<ul style="list-style-type: none"> Please use speakers which have the specified impedance. The protection circuit has been activated because the speaker cable core wires are touching, a core wire has come loose from the terminal, or a core wire is touching the rear panel of this unit. After unplugging the power cord, take corrective action such as firmly re-twisting the core wire or taking care of the terminal, and then reconnect the wire. 	93 93
After turning on the power, the power indicator is blinking red in intervals of approximately 0.5 seconds.	<ul style="list-style-type: none"> This unit amplifier circuit has failed. Turn off the power and please contact the DENON service adviser. 	-
Set does not operate properly.	<ul style="list-style-type: none"> Reset the microprocessor. 	201

[HDMI]

Symptom	Cause/Solution	Page
No audio is output with HDMI connection.	<ul style="list-style-type: none"> Check the connection of the HDMI connectors. When outputting HDMI audio from the speakers, set "HDMI Audio Out" on the menu to "AVR". When outputting HDMI audio from a TV, set "HDMI Audio Out" on the menu to "TV". 	11, 12 129 129
No video is output with HDMI connection.	<ul style="list-style-type: none"> Check the connection of the HDMI connectors. Set the input source to match the connected HDMI connector. Check whether the TV is compatible with copyright protection (HDCP). If connected to a device not compatible with HDCP, video will not be output correctly. 	11, 12 11, 12, 41 14
When the following operations are performed on devices compatible with HDMI control, the same operations occur on this unit. <ul style="list-style-type: none"> Power ON/OFF Switching audio output devices Adjust volume Switch input source 	<ul style="list-style-type: none"> Set "HDMI Control" in the menu to "Off". Furthermore, if you do not want to link the power off operation with devices compatible with HDMI control, set "Power Off Control" in the menu to "Off".	102, 130, 131
When the HDMI ZONE4 function is used and an operation is performed in MAIN ZONE, the following operations occur. <ul style="list-style-type: none"> The player is turned off or playback pauses. The input source on this unit automatically changes. 	<ul style="list-style-type: none"> "HDMI Control" is set to "On" and "Control Monitor" is set to "Monitor 1" or "Monitor 2". In this case, the HDMI control function set for MAIN ZONE affects playback in ZONE4. When using the HDMI ZONE4 function, from the menu, set "HDMI Control" to "Off" or set "Control Monitor" to "ZONE4". When the input source for ZONE4 is "SOURCE", select an input source that is different from the one for MAIN ZONE. 	102, 130 -

Symptom	Cause/Solution	Page
When the HDMI ZONE4 function is used, Dolby TrueHD/ DTS HD Master Audio/Dolby Digital/ DTS cannot be played back in MAIN ZONE.	<ul style="list-style-type: none"> Make sure that "HDMI Audio Out" in the menu is set to "AVR". When a same input source is selected for MAIN ZONE and ZONE4, set the ZONE4 ON/OFF button to "OFF", or change the input source for ZONE4 to an input source that is different from the one for MAIN ZONE. 	129
When the HDMI ZONE4 function is used, no video or audio is output to TV in ZONE4.	<ul style="list-style-type: none"> Make sure that the power is on for ZONE4. Check the input source for ZONE4. Check the output settings (resolution/audio format) for the input device. The HDMI 7 / MHL connector on the front panel does not support the HDMI ZONE4 function. For ZONE4, playback is only possible when the input signals are HDMI signals. 	113 113 – –
When playing back the input device just to use the HDMI ZONE4 function, the TV used for MAIN ZONE is turned on.	<ul style="list-style-type: none"> "HDMI Control" in the menu is set to "On". When using the HDMI ZONE4 function, set "HDMI Control" in the menu to "Off". 	102 , 130

[Video]

Symptom	Cause/Solution	Page
No picture appears.	<ul style="list-style-type: none"> Check the connection between the video output terminal of this unit and the input terminal of the TV. Match the input settings to the input terminal of the TV connected to this unit. 	11 , 16 –

[Audio]

Symptom	Cause/Solution	Page
Audio is not output.	<ul style="list-style-type: none"> Check the connections for all devices. Check the speaker connections and configurations. Check whether the audio device power is turned on. Adjust the master volume. Cancel the mute mode. Check the connection with the playback device and select the proper input source. Match the input mode and the terminal assigned to be the digital input terminal. Disconnect the headphones. No sound is output from the speakers when headphones are connected. 	11 , 12 , 13 , 16 , 17 , 18 , 19 , 20 , 21 , 22 , 23 , 25 , 26 , 27 , 28 , 29 , 30 , 31 94 , 95 , 96 , 97 , 98 , 111 – 42 , 113 42 , 113 41 , 113 138 171
The volume does not increase.	<ul style="list-style-type: none"> The maximum volume is set too low. Set the maximum volume using "Limit" on the menu. Power for external devices connected to the output connectors of the unit may not be turned on. Check the power of connected external devices. 	124 –
No sound is produced from surround speaker.	<ul style="list-style-type: none"> Check if the surround speakers are connected to the SURROUND terminals. 	–
No sound is produced from surround back speaker.	<ul style="list-style-type: none"> Check if "Assign Mode" is set appropriately in order to output audio from the surround back speakers. Set "Speaker Config." – "Surr. Back" on the menu to something other than "None". Set the sound mode to something other than "STEREO" and "VIRTUAL". 	141 142 84
No sound is produced from front height speaker.	<ul style="list-style-type: none"> Set "Speaker Config." – "Front Height" on the menu to something other than "None". 	142
No sound is produced from front wide speaker.	<ul style="list-style-type: none"> Set "Speaker Config." – "Front Wide" on the menu to something other than "None". 	142

Symptom	Cause/Solution	Page
No sound is produced from subwoofer.	<ul style="list-style-type: none"> • Check the subwoofer connections. • Turn on the subwoofer's power. • Set "Speaker Config." – "Subwoofer" on the menu to "2spkr" or "1spkr". • If "Front" and "Center" for "Speaker Config." are set to "Large", and "Subwoofer Mode" is set to "LFE", no sound may be output from the subwoofers, depending on the input signal or selected sound mode. 	94 , 95 , 96 , 97 , 98 – 142 142 , 144
DTS sound is not output.	<ul style="list-style-type: none"> • Set "Decode Mode" on the menu to "Auto" or "DTS". 	138
Dolby TrueHD, DTS-HD, Dolby Digital Plus audio is not output.	<ul style="list-style-type: none"> • Make HDMI connections. 	11 , 12
Dolby PLII mode or DTS NEO:X mode cannot be selected.	<ul style="list-style-type: none"> • Check that "Speaker Config." – "Center" or "Surround" is set to other than "None". If the speaker system is 2.0/2.1ch, this sound mode cannot be selected. • When headphones are used, Dolby PLII or DTS NEO:X cannot be selected. 	142 –
Audyssey MultEQ® XT 32, Audyssey Dynamic EQ® and Audyssey Dynamic Volume® cannot be selected.	<ul style="list-style-type: none"> • Switch the sound mode to other than "DIRECT" or "PURE DIRECT". • When headphones are used, Audyssey MultEQ® XT 32, Audyssey Dynamic EQ® and Audyssey Dynamic Volume® cannot be selected. 	84 –
Audyssey DSX® cannot be selected.	<ul style="list-style-type: none"> • Check that "Speaker Config." – "Front Height" or "Front Wide" is set to other than "None". • Check that "Speaker Config." – "Center" is set to other than "None". • Switch the sound mode to DOLBY listening mode or DTS listening mode. • When headphones are used, Audyssey DSX® cannot be selected. 	142 142 84 –
Audyssey Dynamic EQ® and Audyssey Dynamic Volume® cannot be selected.	<ul style="list-style-type: none"> • Run Audyssey® Setup. 	33 , 99

Symptom	Cause/Solution	Page
"Restorer" cannot be selected.	<ul style="list-style-type: none"> • Check that an analog signal or PCM signal (Sample Rate=44.1/48 kHz) is input. For playback of multichannel signals such as Dolby Digital or DTS surround, "Restorer" cannot be used. • Switch the sound mode to other than "DIRECT" or "PURE DIRECT". 	124 84

[HD Radio]

Symptom	Cause/Solution	Page
Reception fails, or there is a lot of noise or distortion.	<ul style="list-style-type: none"> • Change the antenna orientation or position. • Separate the AM loop antenna from the unit. • Use an FM outdoor antenna. • Separate the antenna from other connection cables. 	27 27 27 27





[iPod / USB memory device / Internet Radio / Media Server / Flickr / Pandora / SiriusXM / Spotify]

Symptom	Cause/Solution	Page
iPod cannot be played.	<ul style="list-style-type: none"> Some iPods do not support being used connected directly to the iPod/USB port. 	23
The file names are not displayed properly ("...", etc.).	<ul style="list-style-type: none"> Characters that cannot be displayed are used. This is not a malfunction. On this unit, characters that cannot be displayed are replaced with a "." (period). Invalid tags are used for files within the USB memory device connected to this unit. Use tags that are supported by this unit. 	– 47
When a USB memory device is connected, "No Connection" is displayed.	<ul style="list-style-type: none"> The set cannot recognize a USB memory device. Check the connection. This unit supports mass storage class and MTP-compatible USB memory devices. It will not recognize other USB memory devices. A USB memory device that the set cannot recognize is connected. This is not a malfunction. DENON does not guarantee that all USB memory devices will operate or receive power. USB memory device is connected via USB hub. Connect the USB memory device directly to the iPod/USB port. The unit supports file structures with up to 8 levels and a total maximum of 5000 subfolders and files per 1 folder. Change the file structure of the USB memory device if necessary. 	23 – – – 47
Files on a USB memory device cannot be played.	<ul style="list-style-type: none"> The USB memory device format should be set to FAT16 or FAT32. For details, refer to the USB memory device's operating instructions. If the USB memory device is divided into multiple partitions, only files in partition one can be played. Files are stored in a non-compatible format. Record the files in a compatible format. You are attempting to play a file that is copyright protected. Files that are copyright protected cannot be played on this unit. 	– – 47 47
Internet Radio cannot be played.	<ul style="list-style-type: none"> Ethernet cable is not properly connected or network is disconnected. Check the connection status. Program is being broadcast in non-compatible format. Only Internet Radio programs in MP3 and WMA can be played on this unit. The firewall of the PC or router has been activated. Check the firewall settings of the connected PC or router. Radio station is not currently broadcasting. Choose a radio station that is currently broadcasting. IP address is wrong. Check the set's IP address. Some radio stations may go silent at certain times of the day. In this case, no audio is output even when a station is received. Try again later, or switch to another radio station. 	31 59 – 59 147 –

Symptom	Cause/Solution	Page
Files stored on a computer cannot be played.	<ul style="list-style-type: none"> Files are stored in a non-compatible format. Record in a compatible format. You are attempting to play a file that is copyright protected. Files that are copyright protected cannot be played on this unit. Set and computer are connected by USB cable. The set's iPod/USB port cannot be used for connection to a computer. Media sharing settings are not correct. Change media sharing settings so that the unit can access the folders on your computer. 	62 62 – 63
Music stored on a NAS cannot be played.	<ul style="list-style-type: none"> If you use a NAS in conformity with the DLNA standard, enable the DLNA server function in the NAS setting. If you use a NAS that does not conform with the DLNA standard, play the music via a PC. Set Windows Media Player's media sharing function and add NAS to the selected play folder. If connection is restricted, set audio equipment as the connection target. 	– 63 –
Server is not found, or it is not possible to connect to the server.	<ul style="list-style-type: none"> The computer's or router's firewall is activated. Check the computer's or router's firewall settings. Computer's power is not turned on. Turn on the power. Server is not running. Launch the server. Set's IP address is wrong. Check the set's IP address. 	– – – 147
Cannot connect to preset or favorite radio stations.	<ul style="list-style-type: none"> Radio station is not currently broadcasting. Wait a while before trying again. Radio station is not currently in service. It is not possible to connect to radio stations that are no longer in service. 	– –
A list of broadcasting stations is not displayed.	<ul style="list-style-type: none"> Connection to the network is unstable. Reconnect to the network or redo the "Network" setting in the menu. 	31 , 146
For some radio stations, "Radio station server full" or "Connection down" is displayed and station cannot be connected to.	<ul style="list-style-type: none"> Station is congested or not currently broadcasting. Wait a while before trying again. 	–
Sound is broken during playback.	<ul style="list-style-type: none"> Network or USB memory device's signal transfer speed is slow or communications lines or radio station is congested. This is not a malfunction. When playing broadcast data with a high bit rate, the sound may be broken, depending on the communications conditions. 	–

Symptom	Cause/Solution	Page
Sound quality is poor or noise is heard during play.	<ul style="list-style-type: none"> File being played has a low bit rate. This is not a malfunction. 	–
Cannot login to Pandora. (“Email address” or “Password” is displayed.)	<ul style="list-style-type: none"> Login information is incorrect. Check if the “Email address” for Pandora has been properly entered. Re-enter the “Password”. (Password is not displayed.) http://www.pandora.com/denon 	69

[AirPlay]

Symptom	Cause/Solution	Page
The AirPlay icon  is not displayed in iTunes or on the iPhone/iPod touch/iPad.	<ul style="list-style-type: none"> This unit and the computer or iPhone/iPod touch/iPad are not connected to the same network (LAN). Connect the computer or iPhone/iPod touch/iPad to the same network as this unit. iTunes or the iPhone/iPod touch/iPad do not have firmware that supports AirPlay installed. Update to the latest firmware. 	31 –
No sound.	<ul style="list-style-type: none"> The volume in iTunes or on the iPhone/iPod touch/iPad is set to the minimum setting. Adjust the volume to the optimum level. This unit is not selected in the screen that is displayed when iTunes or the iPhone/iPod touch/iPad is started. Start iTunes or switch on the iPhone/iPod touch/iPad, click the AirPlay icon  in the displayed screen, and select this unit. AirPlay playback has not started. Click the  button in iTunes or press the  button on the iPhone/iPod touch/iPad. 	– 82 –
When using AirPlay with the iPhone/iPod touch/iPad, the sound suffers from intermittent breaks or AirPlay does not function.	<ul style="list-style-type: none"> Quit the application running in the background of the iPhone/iPod touch/iPad, and then play using AirPlay. When playing via a wireless connection, outside conditions may affect the unit. To remedy this, change the network environment, e.g. shorten the distance to the wireless LAN access point. Update the iPhone/iPod touch/iPad application or iTunes to the latest version. 	– – –



[Remote control unit]

Symptom	Cause/Solution	Page
The set cannot be operated with the remote control unit.	<ul style="list-style-type: none"> Batteries are worn out. Replace with new batteries. Operate the remote control unit within a distance of about 23 ft/7 m from this unit and at an angle of within 30°. Remove any obstacle between this unit and the remote control unit. Insert the batteries in the proper direction, checking the ⊕ and ⊖ marks. The set’s remote control sensor is exposed to strong light (direct sunlight, inverter type fluorescent bulb light, etc.). Move the set to a place in which the remote control sensor will not be exposed to strong light. The setting of the zone to operate does not match. Press ZONE SELECT to select the zone to operate. 	175 175 175 175 175 34, 99, 113

Resetting the microprocessor

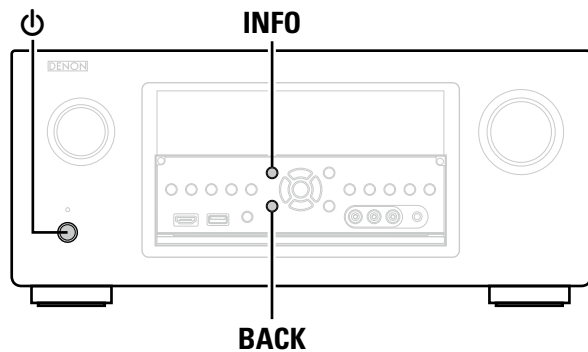
Perform this procedure if the display is abnormal or if operations cannot be performed. When the microprocessor is reset, all the settings are reset to their default values.



- 1** Turn off the power using .
- 2** Press  while simultaneously pressing **INFO** and **BACK**.
- 3** Once the display starts flashing at intervals of about 1 second, release the two buttons.



If in step 3 the display does not flash at intervals of about 1 second, start over from step 1.

Specifications

□ Audio section

• Power amplifier

Rated output:	Front: 150 W + 150 W (8 Ω, 20 Hz – 20 kHz with 0.05 % T.H.D.) 190 W + 190 W (6 Ω, 1 kHz with 0.7 % T.H.D.)
	Center: 150 W (8 Ω, 20 Hz – 20 kHz with 0.05 % T.H.D.) 190 W (6 Ω, 1 kHz with 0.7 % T.H.D.)
	Surround: 150 W + 150 W (8 Ω, 20 Hz – 20 kHz with 0.05 % T.H.D.) 190 W + 190 W (6 Ω, 1 kHz with 0.7 % T.H.D.)
	Surround back / Front height / Front wide: 150 W + 150 W (8 Ω, 20 Hz – 20 kHz with 0.05 % T.H.D.) 190 W + 190 W (6 Ω, 1 kHz with 0.7 % T.H.D.)

Dynamic power:	170 W x 2ch (8 Ω) 280 W x 2ch (4 Ω)
Output connectors:	4 – 16 Ω

• Analog

Input sensitivity/Input impedance:	200 mV/47 kΩ
Frequency response:	10 Hz – 100 kHz — +1, –3 dB (DIRECT mode)
S/N:	102 dB (IHF–A weighted, DIRECT mode)
Distortion:	0.005 % (20 Hz – 20 kHz) (DIRECT mode)
Rated output:	1.2 V

• Digital

D/A output:	Rated output — 2 V (at 0 dB playback) Total harmonic distortion — 0.008 % (1 kHz, at 0 dB) S/N ratio — 102 dB Dynamic range — 100 dB Format — Digital audio interface
--------------------	---

Digital input:

• Phono equalizer (PHONO input – MEDIA PLAYER OUT)

Input sensitivity:	2.5 mV
RIAA deviation:	±1 dB (20 Hz – 20 kHz)
S/N:	74 dB (IHF–A weighted)
Rated output:	150 mV
Distortion factor:	0.03 % (1 kHz, 3 V)

□ Video section

• Standard video connectors

Input/output level and impedance:	1 Vp-p, 75 Ω
Frequency response:	5 Hz – 10 MHz — 0, –3 dB (when “Video Conversion” set to “Off”)
Color component video connector	
Input/output level and impedance:	Y signal — 1 Vp-p, 75 Ω P _B / C _B signal — 0.7 Vp-p, 75 Ω P _R / C _R signal — 0.7 Vp-p, 75 Ω
Frequency response:	5 Hz – 60 MHz — 0, –3 dB (when “Video Conversion” set to “Off”)

□ Tuner section

(ANTENNA input – MEDIA PLAYER OUT)

	[FM]	[AM]
	(Note: μV at 75 Ω, 0 dBf = 1 x 10 ⁻¹⁵ W)	
Receiving Range:	87.5 MHz – 107.9 MHz	530 kHz – 1710 kHz
Usable Sensitivity:	1.5 μV (14.8 dBf)	20 μV
S/N (IHF–A weighted):	MONO 78 dB STEREO 68 dB HD 85 dB	85 dB
Distortion (1 kHz):	MONO 0.1 % STEREO 0.2 % HD 0.02 %	0.02 %

□ Switching hub

Standard

IEEE 802.3 (10 Base-T)-compliant
IEEE 802.3u (100 Base-TX)-compliant
4 ports

Number of ports

□ General

Power supply:	AC 120 V, 60 Hz
Power consumption:	780 W
Power consumption in standby mode:	0.1 W
Power consumption in CEC standby mode:	0.5 W
Power consumption in network standby mode:	5.1 W

For purposes of improvement, specifications and design are subject to change without notice.

Index

Numerics

2ch Playback	145
3D	13
4K	13

A

Accessories	2
Add New Feature	155
Adjust EQ	127
Adjusting the master volume	42
Adobe RGB color / Adobe YCC601 color	193
AirPlay	82, 193
AL32 Processing Multi Channel	193
All Zone Stereo Off	81
All Zone Stereo On	80
AM loop antenna	27
Amp Assign	141
Analog Inputs	137
Analog Video Out	132
App Store	193
ARC	10
Aspect Ratio	132
Audio	120
Audio Delay	124
Audyssey	125
Audyssey DSX®	91, 126
Audyssey Dynamic EQ®	125, 193
Audyssey Dynamic Surround Expansion	193
Audyssey Dynamic Volume®	126, 193
Audyssey LFC™	126, 193
Audyssey MultEQ® XT 32	125, 193
Audyssey® Setup	33, 99
Auto Lip Sync	129, 193
Auto Preset Memory	54
Auto Standby	153

B

Bass	123, 144, 151
Bass Sync	121, 193
Bi-amp	95
Brightness	129

C

Cable	
Audio cable	15
Coaxial digital cable	15
Component video cable	15
Ethernet cable	15
HDMI cable	11, 12
Optical cable	15
Speaker cable	93
Subwoofer cable	93
Video cable	15
Center Gain	122
Center Width	122
Channel	151
Channel Indicators	153
Characters	118
Check Results	40
Cinema EQ	121
Condensation	4
Connection	
Blu-ray Disc player	12, 19
Cable TV	17
CD player	25
Denon Link HD	13
Digital camcorder	12, 21
DVD player	12, 18
EXTERNAL IN	28
External power amplifier	29
Game console	12, 20
HDMI	9
HD Radio reception	27
Home network (LAN)	31
iPod (USB)	23
Media player	12, 22
Mobile	12
Power cord	32
Record player	26
REMOTE CONTROL	30
RS-232C	30
Satellite tuner	17
Set-top box	12, 17
Speaker	93
TRIGGER OUT	30
TV	11, 16
USB memory device	23
Containment Amount	126
Content Type	13
Contrast	129
Control Monitor	130
Crossovers	144
Curve Copy	127

D

Decode Mode	138
Deep Color	14, 193
Delay Time	122
Denon Link HD	13, 42, 193
Diagnostics	149
Dialog Enhancer	121
Digital Inputs	137
Dimension	122
Dimmer	153
Direct Tune	53
Display	172
Distances	143
DLNA	193
Dolby	
Dolby Digital	88, 193
Dolby Digital EX	88, 193
Dolby Digital Plus	88, 193
Dolby Pro Logic II	88, 193
Dolby Pro Logic IIx	88, 193
Dolby Pro Logic IIz	88, 91, 194
Dolby TrueHD	88, 194
Downmix	194
DTS	194
DTS 96/24	88, 194
DTS Digital Surround	194
DTS-ES Discrete 6.1	88, 194
DTS-ES Matrix 6.1	88, 194
DTS Express	88, 194
DTS-HD	88, 194
DTS-HD High Resolution Audio	194
DTS-HD Master Audio	194
DTS Neo:X	88, 91, 194
Dynamic Compression	121
Dynamic EQ	125
Dynamic range	194
Dynamic Volume	126

E

Edit Name	147
Effect Level	122
Enhancer	121, 129
Error messages (Audyssey® Setup)	38

F

Firmware	154
FLAC	194
Flickr	66, 67
FM indoor antenna	27
Format	133

Friendly Name	147
Front Display	153
Front Height	142
Front height speaker	92, 94
Front Panel	170
Front Speaker	145
Front Wide	142
Front wide speaker	92, 94

G

General	150
Graphic EQ	127

H

HDCP	14, 195
HDMI	9, 13, 195
HDMI Audio Out	129
HDMI Control	102, 130
HDMI Pass Through	130
HDMI Setup	129
HDMI ZONE4 function	111
HD Radio reception	50
Headphones	171
Height Gain	123
Hide Sources	137
High Pass Filter	151
Hue	129

I

Impedance	145
Info	133
Information	147, 153
Audio	153
Firmware	154
Video	153
ZONE	154
Input Assign	135
Input Mode	138
Inputs	134
Input Select	138
Input signal	187
Inputting characters	118
InstaPrevue	104
Internet Access	149
iPod Browse Mode	45
i/p Scaler	131
iTunes	195

L	
Language	151
Lch Level	151
Levels	143
LFE	195
Limit	124
Listening mode	84
Listening position	33
Lock	156
Loudness Management	121
Low Frequency Effects	122

M	
Maintenance Mode	149
MAIN ZONE	195
Manual Setup	141
Menu map	114
Mode	124
MP3	195
MPEG	195
MultEQ® XT 32	125
Mute Level	124, 151

N	
Network	40, 146, 147
Noise Reduction	129
Notifications	155
Now Playing	133

O	
On Screen Display	133
Output Settings	131

P	
Pandora®	66, 69
Panorama	122
Pass Through Source	130
Physical Connection	149
Picture Adjust	129
Picture Mode	80, 129
Playback	
ALAC	47, 62
Blu-ray Disc player	42
CD player	43
Denon Link HD	42
Direct	84, 89
DSD Direct	84, 89
DVD player	42
FLAC	47, 62
Flickr	67
HD Radio reception	51

Internet Radio	59
iPod (USB)	44
JPEG	47, 62
MP3	47, 59, 62
MPEG-4 AAC	47, 62
NAS	62
Original listening mode	89
Pandora®	69
PC	62
Pure direct	84, 89
SiriusXM	72
Spotify	74
Stereo	89
Super Audio CD	43
USB memory device	47
WAV	47, 62
WMA	47, 59, 62
ZONE2/ZONE3/ZONE4	113
Power Off Control	131
Power On Level	124
Power On Volume	151
Preset codes	157, 205
Preset Memory	55
Preset Name	56
Preset Skip	57
Progressive	195
Progressive Mode	132
Protection circuit	195

Q	
Quick select	106
Quick Select Names	152

R	
Random	46, 77
Rch Level	151
Rear panel	173
REC OUT mode	107
Reference Level Offset	125
Remote control unit	174
Inserting the batteries	175
Learning function	163
Macro function	165
Operating devices	161
Operating external devices	160
Registering preset codes	157
Setting the back light	168
Remote ID	152
Remove from Favorites	79
Repeat	46, 77

Resetting the microprocessor	201
Resolution	132
Restorer	124
Room Size	122
Router Access	149

S	
Sampling frequency	195
Saturation	129
Save to Favorites	78
Scale	124
Selecting the input source	41
Settings	148
Setup Lock	156
SiriusXM	66, 72
Sleep timer	105, 113
Slideshow	79
Slideshow Interval	79
Sound Mode	84, 184
Source Level	137
Source Rename	137
Speaker	
Connect	93
Install	91
Set up	33, 99
Speaker Config	142
Speaker impedance	93, 195
Speakers	139
Speaker Select	123
Speaker Selection	127
Spotify	66, 74
Stage Height	126
Stage Width	126
Subwoofer	121
Subwoofer 1 Level	121
Subwoofer 2 Level	121
Subwoofer Level	121
Subwoofer setting	34
Surr. Back	142
Surround back speaker	92, 94
Surround Parameter	121
SW Level Matching	39
sYCC601 color	195

T	
Text Search	76
Tone	123
Tone Control	123
Trademark	176
Treble	123, 151
Trigger Out 1/2	152
Troubleshooting	196

Tune Mode	52
Turning off the sound temporarily	42
Turning the power on	41
TV Format	133

U	
Update	154
USB Select	76

V	
Vertical Stretch	130
Video	128
Video conversion	7
Video Conversion	131
Video Mode	131
Video Output	130
Video Select	138
Video Source	138
Volume	124, 133
Volume Level	151
Volume Limit	151
vTuner	61, 195

W	
Web control	108
Windows Media DRM	195
Windows Media Player	195
WMA	195

X	
x.v.Color	195

Z	
ZONE	132
ZONE2 Setup	151
ZONE2/ZONE3/ZONE4	111, 172, 195
ZONE3 Setup	151
Zone mode setting	34, 99
Zone Rename	152

List of preset codes

AVR

D Denon 73347

CBL/SAT group (0****)

CBL

A ABN 03322
 ADB 01927, 02254
 Alcatel-Lucent 02901
 Amino 01602, 01481, 01822, 02482
 Arion 03034, 03336
 Arris 02187
 AT&T 00858
 au 03444, 03445, 03485, 03534

B BBTv 02516, 02518, 02980
 Bell 01998
 BIG.BOX 03465
 Bright House 01376, 01877
 BSI 02979
 BT 02294

C C&M 02962, 02979, 03319, 03407
 Cable Magico 03035
 Cable One 01376, 01877
 Cable&Wireless 01068
 Cablecom 01582
 Cablevision 01376, 01877, 03336
 CCS 03322
 Celrun 02959, 03196, 03442
 Channel Master 03118
 Charter 01376, 01877, 02187
 Chunghwa 01917

Cisco 01877, 00858, 01982, 02345, 02378, 02563, 03028, 03265, 03294
 CJ 03322
 CJ Digital 02693, 02979
 CJ HelloVision 03322
 ClubInternet 02132
 CMB 02979, 03389
 CMBTV 03498
 CNS 02350, 02980
 Com Hem 00660, 01666, 02015, 02832
 Comcast 01376, 00476, 01877, 01982, 02187
 Coship 03318
 Cox 01376, 01877

D Daeryung 01877
 DASAN 02683
 Digeo 02187

Director 00476
 DMT 03036
 DSD 03340
 DST 03389
 DV 02979

E Echostar 03452
 Entone 02302

F Freebox 01976

G GBN 03407
 GCS 03322
 GDCATV 02980
 Gehua 00476

General Instrument 00476

H Hana TV 02681, 02881, 02959
 Handan 03524

HCN 02979, 03340
 HDT 02959, 03465

Hello TV 03322
 HelloD 02979

Hi-DTV 03500
 Hikari TV 03237

Homecast 02977, 02979, 03389
 Huawei 01991

Humax 00660, 01981, 01983, 02165, 02620, 02683, 02701, 02832, 02881, 02962, 03051, 03053

HYA 02989
 Hyroad 02979

I I-Digital 03319, 03499
 i3 Micro 01602

Insight 01376, 01877
 ITV 02979, 03389

J J:COM 02700, 02701, 02703, 02752, 03051, 03053

JCN 03491
 Jerrold 00476

Jiuzhou 01991

K Kabel Deutschland 01981, 01983
 KabelBW 01981, 01983, 02174

Kaon 02979, 03389, 03407
 kbros 02350

KCN 02979, 03389
 KCTV 02979, 03340

KCTV JEJU 02979, 03356
 KCTV-KJ 03500

KDDI 03444, 03445, 03485, 03534
 KDMC 02979

Kiryung 03498
 Kiss 02132

Knology 01877
 KoolConnect 01481

KT 02683, 03478

L LG 02692, 02979, 03196, 03340, 03389, 03406, 03407, 03500
 LG U+ 02682, 03196

M Mediacom 01376, 01877
 Mega 02683

Mega TV 02683
 Minerva Networks 03118

MIO 02275, 02802
 mio TV 02275, 02802

Mitsubishi 03274, 03444, 03485
 Motorola 01376, 00476, 00858, 01562, 01982, 01998, 02275, 02378, 03445, 03534

MovieLink 03276
 Moxi 02187

MTS 01998
 MyLGTV 02682

Myrio 01602, 01822

N Neuf TV 03107
 NIB 03322

Now TV 02014
 NTL 01068, 01060

NTT 03237, 03274
 Nuevo Siglo 03524

O Oi TV 03452, 03454
 OllehTV 02683, 03478

Ono 01068, 01562
 Optus 01060

Orange 02407
 Pace 01376, 01877, 01068, 01060, 01982, 02620, 03454

Panasonic 01982, 02703, 02752, 03474, 03475

Philips 01582, 02174, 02294
 Pioneer 01877, 02700

Pirelli 02944
 Premiere 02620

Prime 03033
 PX 03348

Q Qook TV 02683
 Qrix 02979, 03465

Qtel 01822
R RCN 01376, 00476

Rogers 01877
S Sagem 02407

Samsung 01877, 01060, 01666, 01987, 02015, 02174, 02407, 02610, 02683, 02962, 02979, 03319, 03322, 03340, 03407, 03491

Sasktel 01998
 SBC 03406

Scientific Atlanta 01877, 00858, 01982, 01987, 02132, 02345, 03028

SCS 03500
 SCV 02950

Sejin 01602
 Seokyoung 03340

SetaBox 01917
 SFR 03107

Sharp 03349
 Shaw 01376, 02187

SingTel 01998, 02275, 02802
 SK Broadband 02959, 03442

SK BTv 03442
 SKBtv 02681, 02881, 02959

SKY 02620
 SKY Deutschland 02174, 02620

SkyCable 02893, 02950, 03241, 03318, 03521
 Skyworth 01991, 02893, 03521

SMtronics 03319
 StarHub 01927

Stofa 02015
 Suddenlink 01376, 01877

SureWest 01481, 01998
 Suwon Cable 03319

T T-Home 02132
 Tbroad 03319

TCN 03340
 Technotrend 03035

Telefonica 02901, 02944, 03028, 03033, 03034, 03035, 03036
 Telenet 01920

Telewest 01068, 01987
 Telus 02345

TFN 03127, 03139
 Thomson 01582, 01981, 01982, 01983, 02174, 02407

Time Warner 01376, 01877, 02187
 ToongTV 03322

Topfield 02981
 TopTV 01991

Topway 01991
 TP 02407

True Visions 03075
U U+ 03196

Unihan 02453
 Unitymedia 02610

UPC 01582
V VeeTV 03231

Verizon 02378
 Vidéotron 01877

Virgin Media 01068, 01060, 01987, 02563, 03265

VTR 01376

W Welho 02832
 WideOpenWest 01877

WNC 03118
Y YBN 03322

Yuxing 02014
Z Zhong Hua Dian Xin 01917

Ziggo 00660, 01666, 02015
 ZyXEL 02944

CBL/PVR Combination

A Amino 01822
 Arion 03336

Arris 02187
 au 03444

B BBTv 02980
 Bright House 01376, 01877

C C&M 02962, 03407
 Cable One 01376, 01877

Cablecom 01582
 Cablevision 01376, 01877, 03336

CCS 03322
 Celrun 03442

Charter 01376, 01877, 02187
 Cisco 01877, 01982, 03265

CJ HelloVision 03322
 Com Hem 02832

Comcast 01376, 01877, 01982, 02187
 Cox 01376, 01877

D Digeo 02187

F Freebox 01976

G GCS 03322

H Hana TV 02959
 Handan 03524

Hello TV 03322
 Humax 01981, 01983, 02165, 02620, 02832, 02962, 03051, 03053

I I-Digital 03499
 Insight 01376, 01877

J J:COM 02700, 02703, 03051, 03053

K kbros 02350
 KDDI 03444

Knology 01877
M Mediacom 01376, 01877

Mitsubishi 03444
 Motorola 01376

Moxi 02187
 Myrio 01822

N	Nuevo Siglo	03524
P	Pace	01877, 02620
	Panasonic	01982, 02703
	Philips	01582
	Pioneer	01877, 02700
R	Rogers	01877
S	Samsung	01877, 01987, 03407
	Scientific Atlanta	01877, 01982, 01987
	Shaw	01376, 02187
	SK Broadband	03442
	SK BTV	03442
	SKY	02620
	SKY Deutschland	02620
	SkyCable	03241, 03521
	Skyworth	03521
	StarHub	01927
	Suddenlink	01376, 01877
T	Telenet	01920
	Telewest	01987
	Thomson	01582
	Time Warner	01376, 01877, 02187
	ToongTV	03322
	Topfield	02981
	True Visions	03075
U	UPC	01582
V	Vidéotron	01877
	Virgin Media	01987, 02563, 03265
	VTR	01376
W	Welho	02832
	WideOpenWest	01877
Y	YBN	03322

IP TV

A	ADB	02254
	Alcatel-Lucent	02901
	Amino	01481, 02482
	AT&T	00858
	au	03445, 03485, 03534
B	BBTV	02516, 02518, 02980
	Bell	01998
	BT	02294
C	Celrun	02959, 03196, 03442
	Channel Master	03118
	Chunghwa	01917
	Cisco	00858, 02345, 02378, 03028
	ClubInternet	02132
	CNS	02980
D	DASAN	02683
E	Echostar	03452
	Entone	02302
G	GDCATV	02980

H	Hana TV	02681, 02959
	HDT	02959
	Humax	02683
K	KDDI	03445, 03485, 03534
	Kiss	02132
	KoolConnect	01481
	KT	02683
L	LG	03196
	LG U+	02682, 03196
M	Mega	02683
	Mega TV	02683
	Minerva Networks	03118
	MIO	02275, 02802
	mio TV	02275, 02802
	Mitsubishi	03274, 03485
	Motorola	01376, 00476, 00858, 01998, 02275, 02378, 03445, 03534
	MTS	01998
	MyLGTV	02682
N	Neuf TV	03107
	Now TV	02014
	NTT	03237, 03274
O	Oi TV	03452, 03454
	OllehTV	02683
	Orange	02407
P	Pace	03454
	Philips	02174
	Pirelli	02944
Q	Qook TV	02683
	Qtel	01822
S	Sagem	02407
	Samsung	02174, 02407, 02683
	Sasktel	01998
	Scientific Atlanta	00858, 02345, 03028
	SetaBox	01917
	SFR	03107
	SingTel	01998, 02275, 02802
	SK Broadband	02959, 03442
	SK BTV	03442
	SKBtv	02681, 02959
	SKY Deutschland	02620
	Skyworth	02893
	SureWest	01481, 01998
T	T-Home	02132
	Telefonica	02901, 02944, 03028
	Telus	02345
	Thomson	02174, 02407
U	U+	03196
	Unihan	02453
V	Verizon	02378
W	WNC	03118
Y	Yuxing	02014

Z	Zhong Hua Dian Xin	01917
	ZyXEL	02944
SAT		
	@sat	01300
	@Sky	01334
A	ABsat	00713
	Acoustic Solutions	01284
	ADB	00887, 01887
	AEG	02738, 02813
	Agora	01284
	Airis	01993
	Akura	01626
	Alba	00713, 01284, 02034
	Alltech	00713
	Allvision	01334
	Altech UEC	02059
	Amitronica	00713
	Amstrad	00847, 01175, 00713, 01662, 01693
	Anglo	00713
	Ankaro	00713
	Ansonic	02418
	Apro	01672
	Arena	01736
	Armion	01300
	ASA	00740
	ASCI	01334
	ASLF	00713
	AssCom	00853
	Astra	00713
	Astrell	01986, 02418
	Astro	00173, 00658, 01099, 01100, 01836, 02026, 02627
	Atlanta	02418
	Atom	02289
	Audiola	02418
	Audioline	01672
	Aurora	00879
	Austar	00879
	Auvisio	02531
	Avanit	01631
	Awa	02418
	Axil	01413, 01777, 01993, 02418
	Axitronic	01626
B	B.net	01672
	B@ytronic	00740
	Bell	00775
	Belson	02418
	Best Buy	01993, 02728
	Black Diamond	01284
	Blaupunkt	00173

	Blue Sky	00713
	Boca	00713, 02026, 02308, 02458, 02797, 02813
	Boshmann	01413, 01631
	Boxer	01692, 01957
	Brainwave	00658, 01672
	Broco	00713
	BskyB	00847, 01175, 01662, 01693
	Bubu Sat	00713
	Bush	01284, 01291, 01626, 01672, 01935, 01993, 02034, 02376, 02418, 02813
C	Canal Digital	00853, 01334, 01780
	Canal+	00853, 02657
	CanalSat	00853, 02657
	CDV	01993
	Century	00856
	CGV	01413, 01567, 02034
	Chess	00713, 01334, 01626, 02026
	Signal	02289, 03128
	CityCom	00299, 00658, 01176
	Classic	01672
	Clatronic	01413, 02738
	Clayton	01626
	CMX	02205
	Cobra	02531
	Com Hem	01176, 01915, 02357
	Comag	01413, 01886, 02026, 02308, 02458, 02797, 02813
	Comsat	01413
	Comwell	01956
	Coomax	02531
	Coship	01672
	Croner	02813
	Crown	01284
	CS	01631
	Cyfra+	01409
	Cyfrowy Polsat	00853, 02262, 02527
D	D-box	00723, 01114
	Daewoo	00713
	DAK	01993
	Dantax	01626
	DASAN	03321
	Denver	02418
	Dgtec	01631, 02418
	Di-Way	02289
	Dicra	02738
	Digenius	00299
	Digi	02026
	Digitality	01334
	DigiCrystal	02978
	Digihome	01284, 01935, 02034
	DigiLogic	01284, 02034, 02241

	DigiMax	02273
	DigiQuest	01300, 01631, 02278, 02738
	Digital	02273, 02308
	DigitalBox	01100, 01631, 01886, 02289
	Digiwave	01631
	Dikom	02531
	Dilog	01780, 01957
	DiPro	02278
	DirecTV	01377, 00392, 00566, 00099, 03377
	Dish Network	00775
	Dishpro	00775
	DishTV	01300, 01780
	Diunamai	02531
	DMT	03321
	Doro	01672
	DRE	01176
	Dream Multimedia	01237, 01652, 01923
	DSE	02418, 02813
	DSTV	00879
	Dual	02034
	Durabrand	01284, 02034, 02241
	DVX	01993
	Dyon	02738, 02813
E	Echostar	00775, 00853, 00713, 01323, 01409, 02262, 02272, 02527
	Eco-Star	01413
	Edision	01631, 02306, 02712
	Ei8ht	02978
	Einhell	00713
	Elap	00713, 01413, 01567
	Elbe	02418
	Electron	01956
	Elisa	01322
	Elless	00740
	Elsat	00713
	Embratel	02796
	Energy Sistem	01631, 02289, 02418
	Engel	00713, 01993
	Etisalat	02443
	Europhon	00299, 00713, 01334
	Eurospat	01413, 01611
	Eurosat	01886
	Eurosky	00299, 00740
	Eutelsat	00713
	Eutra	00740
	Evesham Technology	02034
F	Fagor	01611
	Fenner	00713
	Ferguson	01291, 01935
	Finepass	01780
	Finlux	01626

FinnSat	00740, 01195, 01197
Flair Mate	00713
FMD	01413
Fortec Star	01631
Foxtel	00879, 01176, 01356
Fracarro	00713
Freesat	02376
Freesat+	02443
freeview	02982
Fte Maximal	00713, 01886
Fuba	00173, 00299, 02750
Fuji Onkyo	01631, 02728
G Galaxis	00853, 00879
Galaxy	01956
GE	00566
General Instrument	00869
General Satellite	01176
Globo	00740, 01334, 01429, 01626, 02026, 02273
GoGen	02738
GOI	00775
Gold Box	00853
Gold Vision	01631
GoldMaster	01334, 01722
Goodmans	01284, 01291, 02034, 02376
Gradiente	00856, 00099, 00887
Gran Prix	00740
Grandin	01626
Grococ	01409
Grundig	00847, 00853, 00173, 00879, 01284, 01291, 01672, 01780, 02034, 02376
H Haier	02418
Hailo	02289
Hallo	01626
Hama	01567
Handan	01780, 01957
Hanseatic	01099, 01100
Hauppauge	01672
HB	01736
HDT	01255, 03321
Hiro	01886
Hirschmann	00173, 00299, 00740, 01886, 02026
Hitachi	01284, 02034
Homecast	01736
Hornet	01300
HTS	00775
Hughes Network Systems	01377
Humax	01377, 03321, 02736, 02443, 02408, 02357, 02289, 02144, 01989, 01915, 01882, 01808, 01788, 01675, 01427, 01255, 01176

I i-Box	01652
ID Digital	01176
ID Sat	01334, 02289
Illusion	01631
Imperial	01195, 01197, 01334, 01429, 01672
Indovision	00856, 00887, 01255, 01887, 01989
iNETBOX	01237, 01652
Inno Hit	01626
Innova	00099
Inves	01993
inVion	02418
iotronic	01413
IQ	02813
ISkyB	00887
ITT	02418
ITT Nokia	00723
J J-Point	01836
Jaeger	01334
Jerrold	00869
Jiuzhou	03140
JVC	00775
K K-SAT	00713
KabelBW	01195, 01197, 01882, 01915
Kamm	00713
Kaon	01300, 02697
Kathrein	00173, 00658, 00713, 01561, 01567, 02263, 02569
Kenwood	00853
König	01567, 01631, 02289
Koscom	01956
KPN	01986
Kreiling	00658, 01626
Kreiselmeier	00173
KT	03321
L L&S Electronic	01334
LaSAT	00173, 00299, 00740
Lauson	02531
Lava	01631
Leiko	01626
Lemon	01334
Lenco	00713
Lennox	01611
LG	03193, 03321
Lifesat	00299, 00713
Linsar	01284
Listo	01626
Lodos	01284
Logik	01284, 02034
LogiSat	02797, 02813
Lorenzen	00299
Luxor	01935, 02034

M Macab	00853
Magic TV	02982
Majestic	02738
Manata	00713
Manhattan	01300
Maplin	02034
Marusys	02799
Maspro	00173, 00713
Matsui	00173, 01284, 01626
Maxell	03438
Maximum	01334, 01672, 01986, 02813
Mediabox	00853
Mediacom	01206
MediaSat	00853
Mediasat	02750
Medion	00299, 00713, 00740, 01334, 01626, 02026, 02797
Medison	00713
Mega TV	03321
MegaSat	01631, 01886, 02289, 02813
Metronic	00713, 01334, 01413, 01631, 01986, 02418, 02738
Metz	00173
MiCO	01993
Micro	00713, 02797, 02813
Micro electronic	00713, 02308, 02813
Micro Technology	00713
Micromaxx	00299
Microstar	00299
Microtec	00713
Morgan's	00713, 02026
Motorola	00869, 00856, 03469
Movistar	02262, 02263, 02272, 02527, 02761, 03029
Multichoice	00879, 02059, 02060
myfreeviewHD	02982
Mysat	00713
N Neom	01993
NEOTION	01334
NET	02262
Netgem	01322
Netsat	00099, 00887
Neuf TV	01322
Neuhaus	00713
Neuling	02458
Neusat	00713
Next Level	00869
Nextvision	01956
NextWave	01956
Nikkai	01993
Nikko	00723, 00713
Nilox	02278
Nokia	00853, 00723, 01023

Nordmende	01611
NPG	01631, 02289, 02531
O Olleh-Skylife	03321
OllehTV	03321
Omni	01993
Onn	01284, 02034, 02241
Openbox	01956
Opensat	01956
Optex	00713, 01413, 01611, 01626
Opticum	02273
Optus	00879, 01356
Orbis	01334
Orbitech	01099, 01100, 01195, 01197
Orton	02273
	00847, 00853, 00887, 01175, 03482, 03469, 03111, 02796, 02657, 02060, 02059, 01887, 01693, 01682, 01662, 01356, 01323
P Pace	
	01284
Pacific	01284
Palcom	00299, 01409, 01611
Panasat	00879
Panasonic	00847, 01304, 03239, 03484, 03939
Panda	00173
Pass	01567
peekTon	01993, 02418
	00856, 00099, 00853, 00173, 01114, 00887, 01499, 01672, 01836, 02176, 02619, 03469
Philips	
	01956, 02418
Phoenix	
Phonotrend	01780
Pino	01334
Pioneer	00853
Pixel Magic	02982
Pixela	03409
PLDT	02836
PMB	00713, 01611
Premium	01736
Pro Basic	00853, 02205, 02531
Proline	01284
Proscan	00392, 00566
Q Qook TV	03321
Qook-SkyLife	03321
Quelle	00299
R RadioShack	00869
Radix	01255
RCA	00392, 00566, 00855, 01291
RikstV	01692
Roadstar	00853, 00713
Rollmaster	01413
Ross	02540
Rover	00713
Rownsonic	01567

S SAB	01300, 01631, 01956
Saba	00740, 02205
Sagem	01114, 01690, 01692, 03029
Sagemcom	01692
Saivod	02418
Samsung	01377, 00853, 01175, 01206, 01255, 01662, 01682, 03321
Sansui	01545
Sanyo	01626, 03436, 03437
Sat Control	01300
Sat Industrie	01611
Sat Team	00713
SAT+	01409
SatCatcher	01956
Satec	00713
Satlink	02273
Satplus	01100
SatyCon	01631
Schaub Lorenz	02034, 02418
Schneider	01206
	00740, 01334, 01429, 01631, 01672, 02308, 02458, 02797, 02813
Schwaiger	
Scientific Atlanta	01980
SCS	00299, 00740
Sedea Electronique	01206, 01626
Seeltech	01993
SEG	01284, 01626, 01993, 02034
Servimat	01611
ServiSat	00713
Set-One	02728
Shark	01631
Sharp	01935, 02034
Shaw Direct	00869
Sherwood	01409
Siemens	00173, 01334, 01429, 01626, 01657, 01672, 02418
Sigmatek	02418, 02813
SignalMAX	01956
Silva	00299
Silva Schneider	00740
SilverCrest	02026, 02308, 02458
Skantin	00713
SKR	00713
	00856, 00099, 00847, 00887, 01175, 01358, 01499, 01662, 01693, 02619, 03469, 03482
SKY	
	00856, 00887, 01358, 01499, 02619, 03111
Sky Brasil	
SKY Deutschland	00723, 01429, 02176
SKY Italia	00853, 01356, 01693
SKY Mexico	00856, 00887, 01358, 02619, 03469, 03482
SKY PerfecTV!	02299, 03049, 03484, 03939
SkyCable	01631, 01957

SkyLife	01255, 03321
Skymaster	00713, 01334, 01409, 01545, 01567, 01611, 02205, 02241, 02409, 02728
Skymax	01413
Skypex	00740
Skyplus	01175, 00740, 01334, 02026
SkySat	00713, 01100
Skyvision	01334, 02797
Skyworth	01631
SL	00299, 00740, 01672, 02026
SM Electronic	00713, 01409
Smart	00713, 01413, 01631, 02289
Sony	00847, 00853, 01558, 02299, 03049, 03446, 03448
Star	00887
Star Choice	00869
Starland	00713
Stream System	01300
Strong	00853, 00879, 00713, 01284, 01300, 01409, 01626, 02235, 02418, 02813
Sunny	01300
Sunsat	00713
Sunstech	01993, 02738
Supernova	00887
Supratech	01413, 01993
Systec	01334
Sytech	02418
Tatung	03117
TBoston	02418
Teac	01322, 01957, 02813
Technical	01626
Technicolor	03469
Technika	01284, 01672, 02034
TechniSat	01099, 01100, 01195, 01197, 01322
Technoit	02278
Technosat	01206
Technosonic	01672
Technotrend	01429, 01672, 02263
Techwood	01284, 01626, 01935, 02034
TELE System	01409, 01611, 02750, 02813
Telefonica	01692, 02262, 02263, 02272, 02527, 02761, 03029
Telestar	01099, 01100, 01195, 01197, 01334, 01626, 01672, 02540
Televés	01300, 01334
Televisa	00887
Telsey	02738
TelSKY	02540
Tevion	00713, 01409, 01672, 01993, 02026, 02205, 02813
Thomson	00392, 00847, 00853, 01175, 00713, 01291, 01662, 01935, 02176, 02619, 03469

Tiny	01672
Titan	01886, 02205
Tividi	01429, 01736
TNT SAT	01692
Tonna	00713, 01611, 02458
Topfield	01206, 01545, 01722, 01783, 01824, 01986
Toshiba	01284, 01429
Transparent Video Systems	01780, 01957
Triax	00853, 00713, 01291, 01413, 01611, 01626, 01631, 01886, 02026
Tricolor TV	01176
True Visions	02408, 03140
TT-micro	01429
Turnsat	00713
TVB	01989
TWFF	01993
Twiner	00713, 01611
U UEC	00879, 01356, 01358
United	01626, 02278, 02418
Unitymedia	01429, 01882
Univrs	01886
Universum	00173, 00299, 00740, 01099
Unixbox	01652
V Vantage	02297
Vaova	01993
Variosat	00173
VEA	02418
Vestel	01284, 02034
VH Sat	00299
Via Embratel	02796
Viasat	01195, 01197, 01682, 02235
Viola Digital	01672
Vision	01626, 01886
Visiosat	00713, 01413
Vitecom	01413, 02531
Viva	00856
Vivax	02418
Volcasat	02418
Voom	00869
Vu+	02799
W Wavelength	01413
Welho	02357
Wharfedale	01284, 01935, 02034
Winix	02278
Wintel	00299
Wisi	00173, 00299, 00740, 01986
Woxter	02418, 02813
X Xoro	02738, 02813
Xsat	00847, 00713, 01323
Xtreme	01300

Y Yakumo	01413
Yamada	01993
Yes	00887, 01887
Yess	02978
Z ZapMaster	00740
Zehnder	00740, 01334, 01413, 01631, 01777, 02034, 02289
Zenith	00856, 03469
Ziggo	01499, 01657, 02443
Zinwell	02761

CBL/SAT/PVR Combination

C Com Hem	01176, 02357
F Foxtel	01356
H Handan	01957
Humax	01176, 02357, 02443
K Kaon	01300
Kathrein	01561, 02569
P Pace	01356
S Siemens	01657
T TechniSat	01195, 01197
Topfield	01545, 01783
V Vantage	02297
W Welho	02357
Z Ziggo	01657, 02443

SAT - IP TV

D DMT	03321
K KT	03321
L LG	03321
O Olleh-SkyLife	03321
OllehTV	03321
Q Oook-SkyLife	03321
S SkyLife	03321

SAT/PVR Combination

@sat	01300
A AEG	02738, 02813
Amstrad	01175, 01662, 01693
B B@ytronic	00740
Bell	00775
Boca	02308, 02797, 02813
Boxer	01957
BskyB	01175, 01662, 01693
C Canal+	02657
CanalSat	02657
Comag	02308, 02797, 02813
Cyfrowy Polsat	02527
D Digihome	02034
DigiQuest	01300

Digital	02308
Dilog	01957
DirecTV	01377, 00392, 00099, 03377
Dish Network	00775
Dishpro	00775
Dream Multimedia	01237, 01923
Dyon	02738, 02813
E Echostar	00775, 02272, 02527
Edision	01631, 02712
Embratel	02796
Etisalat	02443
Eurosky	00740
F Foxtel	01356
Freesat+	02443
Fuji Onkyo	01631
G Goodmans	02034
H Handan	01957
Hirschmann	00740
Hitachi	02034
Humax	01377, 01176, 01427, 01675, 01788, 01808, 02357, 02443
I ID Sat	01334
iNETBOX	01237
J JVC	00775
K Kaon	01300
Kathrein	00658, 01561, 02569
L LaSAT	00740
LogiSat	02797, 02813
Luxor	01935
M Marusys	02799
Maxell	03438
Maximum	01334, 02813
Mediacom	01206
Medion	00740, 02797
MegaSat	01631, 02813
Micro	02797, 02813
Micro electronic	02308
Motorola	00869
Movistar	02272, 02527, 03029
Multichoice	02059, 02060
N NEOTION	01334
Nokia	01023
O Omni	01993
Orbitech	01195, 01197
Pace	01175, 01356, 01662, 01682, 01693, 02059, 02060, 02657, 02796
Panasonic	01304, 03484, 03939
Philips	00099
Proscan	00392
Ross	02540
R Sagem	01692, 03029

Samsung	01377, 01175, 01206, 01662, 01682
Sansui	01545
Sanyo	03436, 03437
Sat Control	01300
Schneider	01206
Schwaiger	00740, 02308
Sedea Electronique	01206
SEG	02034
Sharp	01935, 02034
Shaw Direct	00869
Siemens	01657
SilverCrest	02308
SKY	01175, 01358, 01662, 01693
Sky Brasil	01358
SKY Italia	01356, 01693
SKY PerfecTV!	02299, 03484, 03939
SkyCable	01631, 01957
Skymaster	01545
Skypex	00740
Skyplus	01175, 00740, 01334
Skyvision	02797
Skyworth	01631
SL	00740
Smart	01631
Sony	02299
Star Choice	00869
Stream System	01300
Strong	01300, 02813
Sunny	01300
T Tatung	03117
Teac	01957
TechniSat	01195, 01197
Technosat	01206
Telefonica	01692, 02272, 02527, 03029
Telestar	01195, 01197, 02540
TelSKY	02540
Thomson	01175, 01662, 01935
TNT SAT	01692
Topfield	01206, 01545, 01783, 01824
UEC	01358
U Vantage	02297
Via Embratel	02796
Viasat	01195, 01197, 01682
Vu+	02799
W Wisi	00740
X Xoro	02738, 02813
Xtreme	01300
Y Yamada	01993
Z Zehnder	00740, 01777, 02034

MEDIA PLAYER / Video - Accessory

A	A.C.Ryan	02709
	ABS	01272
	Acer	01272
	Alienware	01272
	Apple	02615
	Asus	02987
C	Claritas	01272
	CyberPower	01272
D	Daily Media	01272
	Digitech	02260
E	Elonex	01272
	Eminent	02260
	Emtec	02709
F	Fantec	02709
	Fujitsu Siemens	01272
G	Gateway	01272
H	Hewlett Packard	01272
	hFX	01272
	Howard Computers	01272
	Hush	01272
I	iBUYPOWER	01272
	iconBIT	02709
	ISTAR	02260
L	LaCie	03345
	LG	03373
	Linksys	01272
M	Magnavox	03339
	Mede8er	02709
	Media Center PC	01272
	Microsoft	01272, 01805
	Mind	01272
N	Netgear	03292, 03324
	Niveus Media	01272
	Northgate	01272
P	Packard Bell	01272
	Patriot	03307
	Philips	01272, 03526
	PopBox	02260
	Popcorn Hour	02260
R	RCA	03335
	Ricavision	01272
	Roku	02371, 03061
S	Samsung	01967
	Seagate	02698
	Sony	01272, 02713
	Stack 9	01272
	Systemax	01272
T	Tagar Systems	01272
	Tec	03522

	Toshiba	01272
	Touch	01272
	Trust	01272
V	VIA Technologies	01272
	Viewsonic	01272
	Voodoo	01272
W	Western Digital	02558
	Woxter	02709
X	Xbox	01272, 01805
Y	Yamaha	02865
Z	ZT Group	01272

TV group (1 * * * *)

TV

	888	10264
A	A.R. Systems	10556, 10037
	Accent	10037
	Acer	11339
	Acoustic Solutions	11037, 11523, 11667, 11865, 12676
	Action	10650
	Addison	10653, 10108, 10092, 11150
	Admiral	10093, 10463, 10264, 10179, 13485
	AEG	11037, 11163, 11324, 11556, 12197
	Agashi	10264
	Aiko	10037, 10264, 10092
	Aim	10706, 10037
	Aiwa	11910, 11916
	Akai	10812, 10702, 10765, 10178, 10030, 10556, 10037, 10548, 10714, 10264, 10208, 11326, 11413, 11675, 11865, 12414, 12676, 13183
	Akiba	10037
	Akira	11243, 12241
	Akito	10037
	Akura	10171, 10037, 10714, 10668, 11037, 10264, 11363, 11498, 11556, 11585, 11667, 11687, 11770, 11983
	Alaron	10179
	Alba	10037, 10714, 10668, 11037, 10036, 10587, 10443, 10474, 11585, 11865, 12104, 12676
	Alien	11037
	Allstar	10037
	America Action	10180
	Amstrad	10171, 10037, 11037, 10264
	Anam	10250, 10180, 10037, 10650
	Andersson	11163, 11585
	Anglo	10264
	Anhua	10051

	Anitech	10037, 10264, 10474
	Ansonic	10037, 10668
	AOC	10093, 10180, 10178, 10030, 10625, 10108, 10092, 10179, 10474, 11150, 11365, 11589, 12014, 12087, 12214, 12621
	Aolimpike	10264
	Apex Digital	10765, 10767, 12397
	Ardem	10037, 10714
	Arena	10037
	Aristona	10556, 10037
	ART	11037
	Art Mito	11585
	ASA	10179
	Asberg	10037
	Astra	10037
	Asuka	10264
	Asus	12175, 13340
	ATD	10698
	Atlantic	10037
	Audinac	10180
	Audiosonic	10037, 10714, 10264, 11675, 11983, 12104
	Audioton	10264
	Audiovox	10180, 10092, 11276, 11564, 11865, 11937, 12121, 12513
	Audioworld	10698
	Auria	12087, 12277
	Aventura	10171
	Awa	10264, 10036, 10108, 12241
	Axion	11937
	Axxon	10714
B	Baihe	10264
	Baile	10661
	Baird	10208
	Bang & Olufsen	10620
	Baohuashi	10264
	Barco	10556
	Basic Line	10556, 10037, 10668, 11037, 11163
	Baur	10037, 10195, 10512
	Baysonic	10463, 10180
	BBK	11523
	Beaumarck	10178
	Beijing	10812, 10264, 10208, 10661
	Beko	10037, 10714, 10808, 11652, 12125
	Bell & Howell	10017
	Belson	10698, 12032, 12241
	Belstar	11037
	BenQ	11523, 11756, 12449, 12730
	Bensten	11326
	Beon	10037
	Berkshire	10047
	Berthen	10556, 10668

	Bestar	10037
	Bestwell	11326
	Bexa	12493
	BGH	10898
	Black Diamond	11037, 10587, 11163
	Blaupunkt	10195, 10036
	Blue Sky	10556, 10037, 10625, 10714, 10668, 11037, 10624, 11243, 11314, 11324, 11363, 11652, 11916, 12153
	BlueH	11745
	Bluetech	12561
	Boca	11652
	bogo	12561
	Boman	11324
	Bork	11363
	BPL	10037, 10208
	Bradford	10180
	Brandt	10625, 10714, 10560
	Brinkmann	10037, 10668
	Brionvega	10037
	Britânia	12414
	Broksonic	10463
	Bush	10556, 10037, 10714, 10668, 11037, 10698, 10264, 10036, 10587, 12214, 12241, 12676, 12125, 12104, 12053, 12032, 12007, 11983, 11916, 11865, 11687, 11667, 11652, 11645, 11589, 11585, 11556, 11243, 10661, 10443, 10208
	Byd:sign	11311
C	Cameron	11523
	Camper	10037
	Candela	13546
	Candle	10030
	Capetronic	10030
	Capsonic	10264
	Carad	10668, 11037
	Carena	10037
	Carnivale	10030
	Carrefour	10037, 10036
	Cascade	10037
	Casio	10037
	Cathay	10037, 10474
	CCE	10037
	Celebrity	10000
	Celera	10765
	Celestial	10767, 11243
	cello	11770
	Centrum	11037
	Centurion	10037
	Changcheng	10051, 10264, 10661
	Changfeng	10264

	Changhong	10156, 10765, 10264, 10508, 10767, 11156, 11243, 11498, 11910
	Chimei	11666
	Ching Tai	10092, 10179, 10474
	Chun Yun	10000, 10180, 10706, 10092, 10179, 10474, 11150, 11687, 11756
	Chunfeng	10264
	Chung Hsin	10180, 10053, 10036, 10108, 10474, 11150
	Cineral	10092
	Cinex	11556
	Citizen	10180, 10030, 10092
	Clarion	10180
	Clarivox	10037
	Clatronic	10037, 10714, 10264, 11324
	Clayton	11037
	Coby	12306, 12315, 12340, 12343, 12344, 12345, 12347, 12348, 12350, 13478
	Commercial Solutions	10047, 11447
	Condor	10037, 10264
	Conia	11498, 11523, 11687, 12032
	Conrac	10808
	Conrowa	10156, 10698, 10264, 11156
	Contec	10180, 10037, 10036
	Contex	13309
	Coradir	12844
	Cosmel	10037
	CPTEC	10625, 11363
	Craig	10180, 13423
	Crosley	10000
	Crown	10180, 10053, 10037, 10714, 10668, 11037, 10208, 11652
	CTX	11756
	Curtis	11326, 12352, 12397, 12466, 12855, 13228, 13577
	Curtis Mathes	10047, 10051, 10093, 10702, 10030, 11661, 11347
	CXC	10180
	Cyberpix	11667
	Cytron	11326
	Cytronix	11298
D	D-Vision	10556, 10037, 12197
	Daenyx	10180, 10179
	Daewoo	10180, 10178, 10030, 11661, 10556, 10037, 10634, 10108, 10092, 10474, 10624, 10661, 11150, 12098
	Dansai	10037, 10036, 10208
	Dantax	10714, 11037, 11163, 11652, 11916
	Datsura	10208
	Dawa	10037
	Daytron	10180, 10037
	Dayu	10661

De Graaf	10548, 10208
DEC	11326
Decca	10037
Dell	11264, 11863
Denko	10264
Denver	10037, 10587, 11770, 12197
Desmet	10037
Dew	11770
Diamant	10037
Diamond	10706, 10698
Digatron	10037
Digihome	11667
Digiline	10037, 10668
Digisonic	11826
Digitor	10037, 10698
Dikom	12561
Dish Network	11948
Disney	11665, 11892
diVision	12197
Dixi	10037
DL	10587, 11326, 11363
DMTech	11937
Domeos	10668
Dream Vision	11704
Drean	10037
DSE	10698, 10767, 11326, 11556, 12241
Dual	10037, 11037, 11163, 11585, 11667, 12032, 12241, 12676
Dumont	10017
Durabrand	10463, 10180, 10178, 10171, 10714, 11037, 11652, 11665
Dux	10037
DX Antenna	11817, 13460
DX Broadtec	13460
Dynaconnective	12811
Dynatron	10037
Dynex	11810, 12049, 12184
E E.S.C.	10037, 10474
E:max	11324
Easy Living	11666, 12104
ECE	10037
Elbe	10556, 10037
Electroband	10000
Electrohomet	10463, 11670
Elekta	10264
Elektra	10017, 11661
Element	11687, 11886, 12183, 12964, 13559
Elfunk	11037, 11208
ELG	10037
Elin	10037, 10548
Elite	10037

Elta	10264, 10474
Emerson	10463, 10180, 10178, 10171, 11661, 10037, 10714, 10668, 10624, 11394, 10179, 11665, 11864, 11886, 11944, 11963, 12183
Envision	10030, 11365, 11506, 11589, 12014, 12087
Erres	10037
ESA	10812, 10171, 11944, 11963
Essentials	12486
Ether	10030
Eurofeel	10264
Euroman	10037, 10264
Europa	10037
Europhon	10037
Evesham Technology	11248, 11667
Evolution	11756
Evotel	12561
Excello	11037, 11326
Exquisit	10037
F&U	12676
F Fair Mate	11326
Feiyan	10264
Ferguson	10053, 10037, 10625, 10548, 10560, 10195, 11037, 10443, 11585, 11865, 12053
Fidelity	10171, 10037, 10264, 10474, 10512
Finlandia	10548, 10208
Finlux	10556, 10037, 10714, 10179, 10808, 11248, 11556, 11667, 12676
Firstline	10556, 10037, 10714, 10668, 11037, 10208, 10624, 10808, 11363
Fisher	10047, 10036, 10208
Flint	10037, 10264
Fluid	12964
Formenti	10037
Fortress	10093
Fraba	10037
Freesat	11636
Friac	10037
Frigidaire	11826
Frontech	10264, 10474
Fujimaro	11498, 11687
Fujimaru	11687
Fujitsu	10179
Fujitsu Siemens	10808, 11163, 11248, 11298, 11666
Funai	10000, 10180, 10171, 10714, 10668, 11037, 10264, 10179, 11271, 11394, 11666, 11817, 11963
Furi	10264
Futronic	10264

G Futurtech	10180
G-Hanz	12449
G-HanzS	11363
Gaba	11037
Galaxi	10037
Galaxis	10037
Gateway	11756
GE	10047, 10051, 10093, 10180, 10765, 10178, 10030, 11447, 11454, 10625, 10560, 10092, 11347, 11547
GEC	10037
Genesis	10037
Genexxa	10037
Gericom	10808, 11298
GFM	10171, 11665, 11864, 11886, 11963
Gibraltar	10017, 10030
Gibson	11826
Gilma	12449
Gintai	10474, 11150
Global Home	10767
Godrej	11585
Gold	11770
Gold Vision	10661
Goldfunk	10668
GoldStar	10178, 10030, 10037, 10714, 10474, 11150, 11910
Goodmans	10556, 10037, 10625, 10714, 10560, 10668, 10634, 11037, 10264, 10036, 12053, 12393, 12676, 11983, 11916, 11687, 11667, 11645, 11585, 11523, 11163, 10808, 10661, 10624, 10179
Gorenje	11585, 12676
GPX	10179, 13402
Gradiente	10053, 10037, 11804
Graetz	10714, 11163
Granada	10037, 10548, 10560, 10036, 10108, 10208
Grandin	10556, 10037, 10714, 10668, 11037, 10624, 11298, 11652
Grundig	10706, 10556, 10037, 10195, 10036, 10587, 10443, 11223, 11523, 11645, 11667, 11916, 12007, 12053, 12125, 12561
Grunkel	11163
Grunpy	10180, 10179
GVA	11326, 11363, 12098
H H & B	10808
Haaz	10706
Haier	10037, 10698, 10587, 10508, 11748, 11749, 11983, 12214, 12309, 12449, 13382
Haiyan	10264
Halifax	10264
Hallmark	10178

Hankook	10180, 10178, 10030
Hannspree	11348, 11745, 11826
Hanseatic	10556, 10037, 10625, 10714, 10634, 10661, 10808
Hantarex	10037, 12197
Hantor	10037
Harley Davidson	10179
Harvard	10180
Harwood	10037
Hauppauge	10037
Havermy	10093
HB	10714, 11324
HCM	10037, 10264
Heran	11826
Herosonic	11826
Highline	10037, 10264
Hikona	10474, 11983
Himitsu	10180
Hinari	10037, 10264, 10036, 10179, 10208, 10443
HiPlus	11826
Hisawa	10714
Hisense	10156, 10556, 10508, 10208, 11156, 11208, 11314, 11363, 12098, 12183, 12355, 12419
Hitachi	10156, 10150, 10178, 10030, 11145, 11256, 10037, 10548, 10634, 11037, 10036, 10108, 10508, 11643, 11667, 11691, 11854, 12170, 12207, 12214, 12676, 13317, 13456, 11585, 11576, 11163, 11156, 11150, 10744, 10679, 10578, 10474, 10179, 10092
Hitachi Fujian	10150, 10108
Hitec	10698
Höher	10714, 11163, 11556
Hongmei	10093, 10264, 11910
Hongyan	10264
Hornophon	10037
Hua Tun	11150
Huangshan	10264
HuanYu	10264, 11910
Huaqiang	10264
Huari	10264
Hugoson	11666
Huodateji	10051
Hypson	10556, 10037, 10714, 10668, 11037, 10264
Hyundai	10706, 11037, 10698, 10767, 11326, 11523, 11556, 11770, 12676
I Iberia	10037
ICE	10037, 10264
iDEAL	11556
iLo	11286, 11394, 11665, 11684, 11990
Imperial	10037

Imperial Crown	10264, 10661
Indiana	10037
Initial	11990
Inno Hit	11037, 11163, 11585
Innova	10037
Innowert	11298
Insignia	10463, 10171, 11326, 11423, 11564, 11892, 11963, 12049, 12184, 12417
Inspira	11556
Inteq	10017
Interbuy	10037, 10264
Interfunk	10037, 10512
Internal	10556, 10624
Intervision	10037, 10264
Irradio	10037
IRT	11661, 10698
Isis	12676
Isukai	10037
iSymphony	13094
ITS	10037, 10264
ITT	10548, 10179, 10208, 11523, 12125, 12676
ITT Nokia	10180, 10548, 10179, 10208
ITV	10037, 10264
J J:COM	12811
JCB	10000
JCM	12256
Jean	10156, 10051, 10036, 10092, 10179, 10474
Jensen	11326
Jiahua	10051
JiaLiCai	10264
Jinfeng	10051, 10208
Jinhai	11910
Jinque	10264
Jinta	10264, 11910
Jinxing	10156, 10556, 10037, 10698, 10264
JMB	10556, 10634, 10443, 12676
Jubilee	10556
Juhua	10264
JVC	10093, 10463, 10053, 10036, 10650, 10653, 10508, 11253, 11428, 11601, 11774, 12271
K Kaige	10264
Kaisui	10037
Kangchong	11910
Kangli	10264, 10661
Kangyi	10264
Karcher	10714, 10264, 11324, 11556, 12125
Kathrein	10556
KDS	11498, 11687
KEC	10180

Ken Brown	10463
Kendo	10037, 11037, 11585, 12676
Kenia	10030
Kennex	11037
Kenwood	10030
Keymat	11326
Khind	10706, 10661
Kioto	10706, 10556
Kiton	10037, 10668
KLH	10765, 10767
KLL	10037
Kneissel	10556, 10037
	10180, 10150, 10053, 10037, 10036, 10108, 10474, 11150, 11240, 11331, 11610
Kolin	
Kolster	10037
Kongque	10264
König	10037
Konka	10037, 10714, 10587, 10725, 13419
Korpel	10037
Kosmos	10037
KTV	10180, 10030
Kuaile	10264
Kunlun	10051, 10264, 10208, 10661
Küppersbusch	12676
L L&S Electronic	10714, 10808
Lavic	11363
Lavis	11037
Lecson	10037
Lenco	10037, 11037, 10587, 10474, 11983
Leyco	10037, 10264
	10017, 11265, 10178, 10030, 11447, 10556, 10037, 10714, 10698, 10108, 12731, 12424, 12362, 12358, 12182, 11840, 11663, 11423, 10856, 10474
LG	
Liesenkötter	10037
Lifetec	10037, 10714, 10668, 11037
Linetech	12676
Linsar	11585, 11667, 12676
Local India Brand	10264, 10208, 11413
Local Malaysia Brand	10698
Lodos	11037
Loewe	10037, 10512, 10633, 11884
Logik	11037, 10698, 11687, 11865, 12241, 12486
Logix	10668
Longjiang	10264
Luma	11037
Lumatron	10037, 10668, 10264, 11937
Lumenio	10037
Lux May	10037

M

Luxor	10548, 11037, 10179, 10208, 11163, 12676
LXI	10047, 10156, 10178
Madison	10037
MAG	11498, 11687
	10051, 10030, 10171, 11454, 10706, 10036, 10179, 11365, 11455, 11506, 11866, 11867, 11944, 11963, 11990, 12372
Magnavox	
Magnum	10037, 10714, 11556
Mandor	10264
Manesth	10037, 10264
Manhattan	10037, 10668, 11037
Marantz	10030, 11454, 10556, 10037
Mark	10037, 10714
Marks & Spencer	11770
Mascom	11556
Mastro	10053, 10706, 10698, 11556
Masuda	10037, 10264
	10556, 10037, 10714, 10195, 11037, 10036, 10208, 10443, 10744, 11666, 11667, 11916, 12007, 12486, 12676
Matsui	
Matsushita	10250, 10051, 10650
Matsuyama	10587
Maxdorf	11276
Maxent	10762
Maxess	12493
Maxim	11556
Meck	10698
Mediator	10556, 10037
	10556, 10037, 10714, 10668, 11037, 10698, 10512, 10808, 11163, 11248, 11556, 11585, 11667, 12676
Medion	
Megatron	10178
MEI	11037
Meile	10264, 11910
Melectronic	10037, 10714, 10634, 10195, 10512, 10661, 11652
	10250, 10463, 10150, 10178, 11037, 10179, 11665, 11670, 11892
Memorex	11983
Mercury	10037
Mermaid	10037
Metronic	10625
Metz	10668, 10195, 11037, 10587, 11163
MGA	10150, 10178, 10030
Micromaxx	10037, 10714, 10668, 11037, 10808, 11324
Microstar	10808
Midland	10047, 10017, 10051
Mikomi	10744, 11585, 11667
Minato	10037
Minerva	10195, 10108, 11248
Ministry Of Sound	11667

N

Minoka	10037
Mintek	11990
Mirai	11666
Miray	13309, 13321
Mitsai	11556
	10250, 10093, 10180, 10150, 11250, 10178, 10030, 10556, 10037, 11037, 10036, 10108, 13542, 13514, 13500, 13330, 12313, 11797, 11150, 10512, 10474, 10179
Mitsubishi	
Mivar	10609
Moree	10037
Morgan's	10037
Moserbaer	11585, 12449
Motorola	10093
MTC	10030, 10512
MTlogic	10714, 12104
Mudan	10051, 10264, 10208
Multitec	10037, 10668, 11037, 11556
Multitech	10180, 10037, 10264
Murphy	10474
Mx Onda	11498, 11687, 11983
Myrica	11666
Myryad	10556
NAD	10156, 10178, 10037, 11156
Naiko	10037
Nakimura	10037
Nanbao	10264, 11910
Nansheng	10264
National	10051, 10508, 10208
Naxa	12104, 13382
	10156, 10051, 10053, 10178, 10030, 10264, 10036, 10653, 10508, 10474, 10661, 11150, 11704, 11797, 12461
NEC	
Neckermann	10556, 10037
NEI	10037, 11037
NEO	11324
Nesco	10179
Netsat	10037
NetTV	10762
Neufunk	10556, 10037, 10714
New Sonic	11826
New Tech	10556, 10037
Newave	10093, 10178, 10092, 11150
Nexus Electronics	12183
Nikai	11163
Nikkai	10037, 10264, 10036
Nikkei	10714
Nikko	10178, 10030, 10092
Nikon	11910
Nimbro	12104

O

Noblex	10264
Nokia	10180, 10548, 10179, 10208
Norcent	11365, 11589, 11745
	10037, 10714, 10560, 10195, 11163, 11413, 11585, 11667, 12007
Nordmende	
Normerel	10037
Nortek	10668
Norwood Micro	11286
Novatronic	10037
Novex	11523
Novita	11585
NTC	10092
O.K.Line	11037, 11324
Oceanic	10548, 10208
Odeon	10264
Odys	12513
Okano	10037, 10264
OKI	11585, 11667, 12125, 12676
Ölevia	11240, 11331, 11610
Omega	10264
Omni	10698
Onei	11667
Onida	10053, 10653, 11253, 12414
Onimax	10714
Onix	10698
Onn	11667, 11770, 12125
Onwa	10180
Onyx	11770
Opera	10037, 10714, 11770
Optimus	10250, 10650
Optoma	11348
Optonica	10093
Orbit	10037
	10463, 10556, 10037, 10714, 11037, 10264, 10179, 10443, 10474, 11916, 12007, 12032, 12108
Orion	
Orline	10037
Ormond	10668, 11037
Osaki	10556, 10037, 10264, 10474
Osio	10037
Osume	10037, 10036, 10474
Otic	11326, 11498, 11687, 11983
Otto Versand	10093, 10556, 10037, 10195, 10036, 10512
	10556, 10714, 11037, 10443, 11324, 11916
Pacific	
Packard Bell	10092, 11314
Palladium	10556, 10037, 10714
Palsonic	10037, 10698, 10264, 10725, 11326, 12461
Panama	10037, 10264

P

	10250, 10051, 10037, 10548, 10650, 10108, 10508, 12170, 11946, 11941, 11650, 11636, 11480, 11291, 11271, 11168, 10208
Panasonic	
Panavision	10037
Panda	10051, 10706, 10698, 10264, 10508, 10208, 11910
PARK	12104
Penney	10047, 10156, 10051, 10178, 10030, 11347
Perdio	10037
Perfekt	10037
Petters	10037, 11523
	10463, 10180, 10178, 10030, 10171, 11661, 10037, 13426, 13022, 12414, 11963, 11665, 11394, 11271, 10474, 10179, 10092
Philco	
	10017, 10000, 10051, 10178, 10030, 10171, 11454, 10556, 10037, 10108, 11756, 11866, 11867, 11887, 12227, 12372, 12374, 12800, 11744, 11506, 11455, 11394, 10810, 10639, 10512, 10474, 10092
Philips	
Phocus	10714, 11652
Phoenix	10037
Phonola	10556, 10037
Pilot	10030, 10706
Pioneer	10037, 10698, 10512, 10679, 11260, 11457, 11636
Pionier	11556
Pixela	13496
Planar	11589
Plantron	10037, 10264
Playsonic	10037, 10714, 11652
Plustron	11770
	10765, 11276, 11286, 11314, 11326, 11498, 11523, 11645, 11687, 11826, 12121, 12125
Polaroid	
Polyvision	10889
Portland	11661, 10092, 10624
Power Acoustik	11865
Powerpoint	10037, 10698, 11770
Premier	10264
Prima	10264, 10474, 11749
Princess	11326
Prinston	11037
Prism	10051
Pro Vision	10556, 10037, 10714, 11324, 12197
Prodia	13496
Profilo	11556
Profitronic	10037
Proline	10037, 10625, 10634, 11037
Proscan	10047, 10030, 11447, 11347, 12147, 12183, 12256, 13577
Proscoc	10156

Prosonic	10037, 10714, 10668, 11163, 11314, 11324, 11523, 11585, 11667, 11770, 11865, 12125, 12197, 12676
Protech	10037, 10668, 11037, 10264
Proton	10178, 10030, 10474
Proview	11498, 11687
Pulsar	10017
Pye	10556, 10037
Q Qingdao	10051, 10264, 10208
Quadro	11326
Quasar	10250, 10051, 10650, 10474, 11291
Quelle	10037, 10668, 10195, 11037, 10512
Questa	10036
R R-Line	10037
Radiola	10556, 10037
Radiomarelli	10037
RadioShack	10047, 10180, 10178, 10030, 10037
Radiotone	10037, 10668, 11037, 10264
Rank Arena	10036
	10047, 10000, 10051, 10093, 10178, 10030, 11661, 11447, 11454, 10625, 10560, 10618, 12746, 12434, 12247, 12932, 12187, 13577, 11953, 11948, 11781, 11547, 11347, 10679, 10624, 10092, 10090
RCA	
Realistic	10180, 10178, 10030
Recco	10706
Recor	10037
Rectiligne	10037
Red	12032
Red Star	10037
Rediffusion	10548, 10036
Reflex	10037, 10668, 11037
Relisys	11585, 11645
Relon	11826
Remotec	10250, 10093, 10171, 10037
Reoc	10714, 12197
Revox	10037, 10808
Rex	10264
RFT	10037, 10264
Roadstar	10037, 10714, 10668, 11037, 10264, 11916
Rolsen	12098
Rover	10036
Rowa	10037, 10698, 10264, 10587, 10898, 12042
Runco	10017, 10030
S Saba	10250, 10625, 10548, 10714, 10560
Sagem	10618
Saisho	10264
Saivod	10037, 10668, 11037, 11163, 11556

Sakura	11326
Salora	10548, 10208, 11556, 12125, 12197
Sampo	10093, 10178, 10030, 10171, 10036, 10650, 10092, 10474, 10762, 10898, 13419
	10156, 10093, 10812, 10702, 10178, 10030, 10556, 10037, 10264, 10587, 10618, 10650, 10179, 10208, 10474, 10092, 10090, 11150, 11619, 11632, 12042, 12051
Samsung	
Sanjian	10264
Sanken	12042
Sansei	10092
	10463, 10171, 10706, 10037, 10714, 10898, 11243, 11248, 11413, 11556, 11670, 11892, 13564
Sansui	
	10156, 10180, 11037, 10264, 10036, 10508, 13348, 12676, 12461, 11667, 11585, 11498, 11365, 11276, 11208, 11150, 11142, 10474, 10208
Sanyo	
Sanyuan	10093
SBR	10556, 10037
Sceptre	11360, 11599, 12337, 12506
Schaub Lorenz	10548, 10714, 11324, 11363, 11667, 12125, 12241, 12676
Schneider	10556, 10037, 10714, 10668, 11037, 12676
Schöntech	11037
Scotch	10178
Scott	10180, 10178, 10179, 11983
Sears	10047, 10156, 10178, 10171, 10179
Seaway	10634
Seelver	11037
SEG	10037, 10668, 11037, 10264, 10036, 10624, 11163, 11523, 12125
SEI	10037
Sei-Sinudyne	10037
Seiki	10178, 12964, 13559
Semivox	10463, 10180
Semp	10156, 11743
Semp Toshiba	10156, 11743
Sencor	10714
Sens	11865
Serie Dorada	10156, 10180, 10178, 10030
Serino	10093
Shancha	10264
Shanghai	10264, 10208, 11910
	10093, 10053, 10030, 10036, 10650, 11193, 13101, 12810, 12676, 12360, 12214, 11659, 11423, 11407, 11393, 10818, 10474
Sharp	
Shen Ying	10092, 10179, 10474
Shencai	10264
Sheng Chia	10093, 10179, 10474, 11150

Shenyang	10264
Shinco	11990
Shinelco	12104
Shintoshi	10037
Shivaki	10178, 10037, 10443
Shorai	10179
Siam	10037
Siemens	10037, 10195
Siera	10556, 10037
Sigmac	13423
Silva	10037
Silva Schneider	10037, 11556, 12125, 12197
Silvano	10587
Silver	10036, 10179
SilverCrest	11037, 12676
Singer	11556
Sinudyne	10037
SKY	10037, 11745
Skygiant	10180
Skyworth	10037, 10698, 10264
Sliding	11324
SLX	10668
Soemtron	11298
Solavox	10037, 10548
Soniko	10037
Soniq	12493
Sonitron	10208
Sonneclair	10037
Sonoko	10037, 10264
Sonolor	10548, 10208
Sontec	10037
Sontech	11983
	10000, 11505, 10036, 10810, 11300, 11551, 11625, 11651, 11825, 12568, 12571, 12736, 12747, 12778
Sony	
Soundesign	10180, 10178, 10179
Soundwave	10037, 11037
Sowa	10156, 10051, 10178, 10036, 10092, 10474, 11150
Soyea	12042
Soyo	11826
Spectroniq	11498, 11687
Squareview	10171
SR Standard	10037, 11037
SSS	10180
Starlite	10180, 10037, 10264
Stern	10264
Strato	10037, 10264, 12032
Strong	11163
SunBriteTV	11610, 12337
Sungoo	11248
Sunny	10037

Sunstar	10037, 10264
Sunview	13265
Sunwood	10037
Superscan	10093, 10864, 11944
Supersonic	10208, 12104
SuperTech	10556, 10037
Supra	10178
Supreme	10000
Susumu	10474
SVA	10587, 11326, 11498, 11963, 12042
Svasa	10208
Swisstec	11745, 12104, 12106
	10030, 10171, 10587, 11271, 11314, 11394, 11665, 11864, 11886, 11944, 11963
Sylvania	
Symphonic	10180, 10171, 11394, 11944
Synco	10000, 10093, 10178, 10036, 10092, 10474, 11826
Syntax	11240, 11331, 11610
Sysline	10037
T Tacico	10178, 10092, 10179, 10474, 11150
Tai Yi	11150
Talent	10178
Tandy	10093
Tashiko	10036, 10650, 10092, 11150
	10156, 10051, 10037, 10036, 10474, 11150, 11156, 11248, 11286, 11324, 11556, 11687, 11756, 11916
Tatung	
Taurus	12197
TCL	10706, 10698, 10898, 11916, 12414, 12434, 12449, 13183
TCM	10714, 10808
	10178, 10171, 10706, 10037, 10714, 10668, 11037, 10698, 10264, 10587, 10624, 10512, 10898, 11248, 11363, 11645, 11770, 11983, 12032, 12241
Teac	
Tec	10037, 10474
Tech Line	10037, 10668, 11163
Technica	11037, 12106
Technics	10250, 10051, 10556, 10650
Technika	11667, 11865, 11983, 12032, 12106, 12125, 12197, 12676
TechniSat	10556
Technisson	10714, 11652
Techno	11585
Technol Ace	10179
Technosonic	10556, 10625, 11324, 11326, 12032
Techvision	12032
Techwood	10051, 11037, 11163, 11667, 12676
Tecnimagen	10556
	10051, 10093, 10053, 10178, 10030, 10264, 10036, 10653, 10092, 10474, 10762, 11523, 11687, 11838
Teco	

Tedex	10208
Teknika	10180, 10150, 10092, 10179
TELE System	11585, 12125
Telecor	10037
	10702, 10037, 10625, 10714, 10560, 10698, 10587, 11243, 11326, 11556, 11585, 11667, 12676
Telefunken	
Telefusión	10037
Telegazi	10037, 10264
Telemeister	10037
Telesonic	10037
Telestar	10556, 10037
Teletex	10037, 10668, 11037
Teleton	10036
Television	10037
Tempest	10264
Tennessee	10037
Tensai	10037, 11037
Tera	10030, 10092, 10474
Tesla	10556, 10037, 10714, 11037, 11652
	10556, 10037, 10714, 10668, 11037, 12241, 12032, 11687, 11667, 11645, 11585, 11556, 11498, 11298, 11248, 10808, 10767
Tevion	
Thomson	11447, 10037, 10625, 10560
Thorn	10037, 10036, 10512
Tiane	10093
TMK	10178
TML	11756
TNCi	10017
Tobo	10264
Tokai	10037, 10668, 11037
Tokaido	11037
Tongguang	10264
Tongtel	10587
Tophouse	10180
Topline	10668, 11037
	10156, 10093, 11265, 11256, 10195, 11037, 10264, 10036, 10618, 10650, 10508, 11945, 12006, 12311, 12676, 12724, 13105, 13492, 13503, 13504, 13570, 11916, 11743, 11704, 11656, 11652, 11556, 11524, 11508, 11156, 11150, 10767
Toshiba	
Tosumi	11770
Toyota	10264
Trakton	10264
TRANS-continents	10556, 10037, 10668, 11037
Transonic	10037, 10698, 10264, 10587, 10512, 11326, 11363
Triad	10556
Trio	11248, 11498, 11687
Tristar	10264

Triumph	10556, 10037
TruTech	11665
Tuntex	10030, 10092, 10474
TVS	10463
TVTEXT 95	10556
Uher	10037
Ultravox	10037
UMC	11745, 12106
Unic Line	10037
Uniden	12122
United	10556, 10037, 10714, 11037, 10587, 11163, 11523, 11652, 11770, 11916, 11983, 12125
Universal	10037, 10714
Universum	10037, 10668, 10195, 11037, 10264, 10036, 10618, 10474, 10512, 10808, 11163
Univox	10037
US Logic	11286
V7 Videoseven	11666
Vector Research	10030
Venturer	11865
Venus	11326
Vestel	10037, 10668, 11037, 11163, 11585, 11667
Vexa	10037
Victor	10250, 10053, 10036, 10650, 10653, 11428
Videocon	10037, 10508
VideoSystem	10037
Vidtech	10178, 10036
Viewsonic	10864, 10885, 11365, 11564, 11578, 11627, 11742, 11745, 12014, 12049, 12087, 12277, 13247
Viore	11684, 12104, 12352, 13094, 13118, 13382
Vision	10037, 10264, 10474, 11826
Vistron	11363
Visual Innovations	12106
Vito	12376
Vivax	11326
Vizio	10864, 10885, 11756, 11758, 12116, 12512, 12757, 13758
Vortec	10037
Voxson	10178, 10037, 12197
VU	11365, 12098, 12449
Walker	11667
Waltham	10037, 10668, 11037, 10443
Wansa	12098
Wards	10047, 10017, 10000, 10156, 10051, 10180, 10178, 10030, 10179, 11156, 11347
Warumaia	10661
Watson	10037, 10714, 10668, 11037
Waycon	10156
Wega	10037, 10036

Welltech	10714, 11652
Weltstar	11037
Westinghouse	10885, 10889, 11282, 11300, 11577, 11712, 11826, 13470, 13579
Wharfedale	10556, 10037, 11324, 11556, 11667, 11983
White Westinghouse	10463, 11661, 10037, 10624
Wilson	10556
Windsor	10668, 11037
Windy Sam	10556
Wintel	10714
World-of-Vision	11298
Wyse	11365
Xenius	10634, 10661
Xi-En	11770
Xiahua	10698, 10264
Xiangyang	10264
Xihu	10264
Xinghai	10264
Xinrisong	11910
Xiron	11983
XLogic	10698
Xococo	10725, 12121, 13022
Xomax	11770
Xoro	11243
Xrypton	10037
Xuelian	11910
Yamaha	10030, 10650, 11407, 11576
Yamishi	10037
Yapshe	10250
Yokan	10037
Yoko	10037, 10264
Yongbao	11910
Yousida	11910
YU-MA-TU	10037
Zenith	10047, 10017, 10000, 10463, 11265, 10178, 10030, 11145, 11661, 10092, 10624, 11365, 11423, 12358, 12362, 12731
Zepto	11585
Zinwell	12116
Zonda	10698

TV/DVD Combination

A Acoustic Solutions	11865
AEG	12197
Akai	11675, 11865, 12676
Akura	11770, 11983
Alba	10587, 11865, 12104, 12676
Audiosonic	11983, 12104
Audiovox	11865, 11937, 12513
Axion	11937

B Belson	12241
Black Diamond	11037
Blue Sky	11037, 12153
Bush	11037, 10698, 10587, 11556, 11983, 12104, 12676
C cello	11770
Centrum	11037
Changhong	11243
Coby	12315, 12340, 12343, 12344, 12347, 12350
Coradir	12844
Crown	11037
Curtis	12466, 12855
D D-Vision	12197
Denver	10587, 11770, 12197
Dew	11770
DMTech	11937
Dual	11037, 12241
Dynaconnective	12811
Dynex	11810, 12049, 12184
E Easy Living	12104
Electrohome	11670
Elfunk	11037
Emerson	11394, 11864, 11886, 11963
ESA	11963
Essentials	12486
F Ferguson	11037
Finlux	11556
Funai	11963
G GFM	11963
Gold	11770
Goodmans	11037, 11687, 11983, 12676
H Haier	11748, 12309
Hantarex	12197
Hikona	11983
Hitachi	11037, 11667, 12207, 12676, 13317, 13456
Hyundai	11770
I iLo	11990
Initial	11990
Insignia	11963, 12049, 12417
iSymphony	13094
J J.COM	12811
JVC	11774, 12271
L Lenco	10587, 11983
LG	11423
Linsar	12676
Logik	11037, 11687, 11865, 12486
Luxor	11037
M Magnavox	11866, 11944, 11963, 11990, 12372
Marks & Spencer	11770
Matsui	11037, 12486, 12676
Medion	12676

Memorex	11670
Memory	11983
Mintek	11990
Mitsubishi	13330
MLogic	12104
Mx Onda	11983
N Naxa	12104, 13382
Nimbro	12104
O Onn	11770
Onyx	11770
Opera	11770
Otic	11983
P Panasonic	11941, 12170
Philips	11454, 10556, 11394, 12372
Plustron	11770
Polaroid	11523
Power Acoustik	11865
Powerpoint	10698, 11770
Proscan	12256
Prosonic	11770, 11865, 12197, 12676
RCA	11447, 11948, 12187, 12746, 12932
S Salora	12197
Samsung	12051
Sansui	11670, 13564
Sanyo	12676
Scott	11983
SEG	11037
Sens	11865
Sharp	10818, 12360, 12676
Shinco	11990
Shinelco	12104
Soniq	12493
Sontech	11983
Sony	12778
Supersonic	12104
Swisstec	12104
Sylvania	10171, 11394, 11864, 11886, 11963
T Taurus	12197
TCL	11916
Teac	10698, 10587, 11770, 11983, 12241
Technica	11037
Technika	11865, 11983, 12106
Telefunken	10698
Teletech	11037
Tevion	12241
Thomson	10625
Toshiba	11256, 11524, 12006, 13105, 13492
Tosumi	11770
Transonic	10587

U UMC	12106
United	11037, 10587, 11770, 11983
V Venturer	11865
Vestel	11037
Viewsonic	10864, 12049
Viore	12104, 12352, 13094, 13118, 13382
W Weltstar	11037
Westinghouse	11300, 11712
Wharfedale	11983
X Xiron	11983
Xomax	11770

TV/VCR Combination

A Aiwa	11910, 11916
America Action	10180
Amstrad	10171
Audiovox	10180
B Blue Sky	10624, 11916
Broksonic	10463
Bush	11916
C Curtis Mathes	10051
D Daewoo	10624
Dantax	11916
E Emerson	10463, 10624
F Ferguson	10625
Fidelity	10171
Firstline	10624
G GE	10047, 10051, 10093
GoldStar	10037
Goodmans	10624, 11916
Gradiente	11804
Grandin	10624
Grundig	10556, 10037, 10195, 11916
H Hinari	10036, 10179
I Internal	10624
J JVC	11253
L LG	10178
M Matsui	11916
Memorex	10250
Mitsubishi	10093, 10556, 11150
O Orion	10463, 11916
P Pacific	11916
Panasonic	10250, 10051
Penney	10051
Philips	10556, 10037
Portland	10624
Q Quasar	10250, 10051
R Radiola	10556
RCA	10047, 10051, 10093
Roadstar	11916

S	Saba	10625
	Sansui	10463
	Schneider	10556, 10037
	SEG	10624
	Sharp	10093
	Siemens	10037
	Sony	10000, 11505
T	Tatung	11916
	Teac	10178, 10171, 10624
	Technics	10556
	Thomson	10625
	Toshiba	11916, 11945, 12006
U	United	11916
W	White	
	Westinghouse	10624
Z	Zenith	10017

TV/VCR/DVD Combination

E	Emerson	11944, 11963
	ESA	11944
I	Insignia	11963
M	Magnavox	11944, 11963
P	Panasonic	11941, 11946
R	RCA	11953
S	Superscan	11944
	Sylvania	11944
	Symphonic	11944
T	Toshiba	11945

VCR/PVR group (2****)

VCR

A	ABS	21972
	Accent	20072
	Accurian	20000
	Admiral	20048, 20209
	Adventura	20000
	Adyson	20072
	AEG	21593
	Aiko	20278
	Aim	20278, 20642
	Aiwa	20037, 20032, 20000, 20209, 20041, 20742, 21137
	Akai	20037, 20240, 20000, 20041, 20642
	Akiba	20072
	Akura	20041, 20072
	Alba	20081, 20000, 20209, 20072, 20278
	Alienware	21972
	Allegro	20039, 21137

	Allorgan	20240
	Allstar	20081
	America Action	20278
	American High	20035
	Amstrad	20000, 20072, 20278
	Anam	20162, 20037, 20240, 20278, 21562
	Anitech	20072
	Ansonic	20000
	Aristona	20081
	ASA	20037, 20081
	Asha	20240
	Asuka	20037, 20081, 20000, 20072
	Audiolab	20081
	Audiosonic	20278
	Audiovox	20037, 20278
	AVP	20000
	Awa	20037, 20043, 20278, 20642, 20320

B	Baird	20000, 20104, 20041, 20278
	Basic Line	20104, 20072, 20278
	Beaumarck	20240
	Bell & Howell	20104
	Bestar	20278
	Black Diamond	20642
	Black Panther	20278
	Blaupunkt	20037, 20209, 20072, 20278, 20642, 20742, 21137
	Blue Sky	20037, 20209, 20072, 20278, 20642, 20742, 21137
	Bondstec	20072
	Brandt	20041, 20320
	Brandt Electronique	20041
	Brinkmann	20209
	Broksonic	20121, 20209, 20742
	Bush	20081, 20000, 20209, 20072, 20278, 20642, 20742

C	Calix	20037
	Canon	20035
	Carena	20081, 20209
	Carrefour	20045
	Carver	20081
	Casio	20000
	Cathay	20278
	CCE	20072, 20278
	Centrum	20593, 21593
	CGE	20000, 20041
	Changhong	20048, 20081
	Cimline	20209, 20072
	Cineral	20278
	CineVision	21137
	Citizen	20037, 20278
	Clatronic	20000, 20072, 21593
	Colt	20072

	Condor	20278
	Craig	20037, 20047, 20240, 20072
	Crosley	20081, 20000
	Crown	20037, 20072, 20278
	Curtis Mathes	20060, 20035, 20162, 20240, 20041, 20278
	Cybermex	20240
	CyberPower	21972
	Cyrus	20081
D	Daewoo	20045, 20104, 20209, 20278, 20642, 21137
	Dansai	20072, 20278
	Dantax	20742
	Daytron	20278
	De Graaf	20048, 20081, 20042, 20104
	Decca	20081, 20000, 20067, 20209, 20041
	Deitron	20278
	Dell	21972
	Denko	20072
	Denon	20042
	Diamant	20037
	Digitor	20642
	DirectTV	20739
	Domland	20209
	DSE	20000, 20642, 21593
	Dual	20081, 20000, 20041, 20278
	Dumont	20081, 20000, 20104
	Durabrand	20039, 20642, 20593, 21593
	Dynatech	20000

E	E.S.C.	20240, 20278
	Elbe	20278
	Elcatech	20072
	Electrohome	20037, 20043
	Electroponic	20037
	Elin	20240
	Elsay	20072
	Elta	20072, 20278
	Emerex	20032
	Emerson	20035, 20037, 20240, 20045, 20000, 20121, 20043, 20209, 20072, 20278, 20593, 21593
	ESA	21137
	EuroLine	21593

F	Ferguson	20000, 20041, 20278, 20320, 20742
	Fidelity	20240, 20000, 20072
	Finlandia	20037, 20048, 20081, 20000, 20042, 20104, 20043
	Finlux	20081, 20000, 20042, 20104
	Firstline	20037, 20045, 20042, 20043, 20209, 20072, 20278, 21137
	Fisher	20047, 20104
	Flint	20209
	Frontech	20072

	Fuji	20035, 20033
	Fujitsu	20045, 20000
	Fujitsu General	20037
	Fujitsu Siemens	21972
	Funai	20000, 20593, 21593
G	Galaxi	20000
	Galaxis	20278
	Garrard	20000
	Gateway	21972
	GE	20060, 20035, 20048, 20240, 20320, 20202
	GEC	20081
	General	20045
	Genexxa	20104
	GFM	21593
	Go Video	20240, 21137
	GoldHand	20072
	GoldStar	20037, 20000, 20209, 21137
	Goodmans	20037, 20081, 20240, 20000, 20209, 20072, 20278, 20642, 20742
	GPX	20037
	Gradiente	20000, 21137
	Graetz	20240, 20104, 20041
	Granada	20037, 20048, 20081, 20240, 20000, 20042, 20104
	Grandin	20037, 20000, 20209, 20072, 20278, 20742
	Grundig	20081, 20072, 20320, 20742
H	Hanseatic	20037, 20081, 20209
	Haojie	20240
	Harley Davidson	20000
	Harman/Kardon	20081
	Harwood	20072
	HCM	20072
	Hewlett Packard	21972
	HI-Q	20047
	Hinari	20240, 20209, 20041, 20072, 20278
	Hisawa	20209
	Hischito	20045
	Hitachi	20037, 20081, 20240, 20000, 20042, 20041, 20593
	Höher	20278, 20642
	Hornophon	20081
	Howard Computers	21972
	Hughes Network Systems	20042
	Humax	20739
	Hush	21972
	Hypson	20037, 20000, 20209, 20072, 20278
I	iBUPOWER	21972
	Imperial	20000
	Ingersoll	20240, 20209
	Inno Hit	20072

	Instant Replay	20035
	Interbuy	20037, 20072
	Interfunk	20081, 20104
	Internal	20278
	International	20037, 20278, 20642
	Intervision	20037, 20000, 20209, 20278
	Irradio	20037, 20081, 20072, 21137
	ITT	20240, 20104, 20041
	ITV	20037, 20278
J	JBL	20278
	Jensen	20041
	JMB	20209, 20742
	Joyce	20000
	JVC	20081, 20045, 20067, 20041
K	Kaisui	20072
	Kambrook	20037
	Karcher	20081, 20278, 20642
	KEC	20037, 20278
	Kendo	20037, 20209, 20072, 20278, 20642
	Kenwood	20067, 20041
	KIC	20000
	Kimari	20047
	KLH	20072
	Kneissel	20037, 20209, 20278
	Kodak	20035, 20037
	Kolin	20043, 20041
	Kolster	20209
	Korpel	20072
	Kuba Electronic	20047
	Kyoto	20072
L	Lenco	20278
	Leyco	20072
	LG	20037, 20045, 20000, 20042, 20209, 20278, 21137
	Lifetec	20209
	Linksys	21972
	Lloyd's	20000
	Loewe	21062, 20162, 20037, 20081, 21562
	Logik	20240, 20209, 20072
	Lumatron	20593, 21137
	Lunatron	21137
	Lux May	20072
	Luxor	20048, 20047, 20104, 20043, 20072
	LXI	20037
M	Magnasonic	20278, 20593
	Magnavox	20035, 20039, 20081, 20000, 20642, 20593, 21593
	Magnin	20240
	Magnum	20642
	Manesth	20081, 20045, 20209, 20072
	Marantz	20035, 20081, 20209

Mark	20000, 20278
Marta	20037
Mascom	20642
Mastec	20642
Master's	20278
Matsui	20037, 20240, 20209, 20278, 20742
Matsushita	20035, 20162
Media Center PC	21972
Mediator	20081
Medion	20209, 20642
MEI	20035
Meletronic	20037, 20000
Memorex	20035, 20162, 20037, 20048, 20039, 20047, 20240, 20000, 20104, 20209
Memphis	20072
Metronic	20081
Metz	21062, 20162, 20037, 20081, 21562, 20836, 20837
MGA	20240, 20043
MGN Technology	20240
Micromaxx	20209
Microsoft	21972
Migros	20000
Mind	21972
Minolta	20042
Mitsubishi	20048, 20081, 20000, 20067, 20043, 20041, 20642
Motorola	20035, 20048
MTC	20240, 20000
Multitec	20037
Multitech	20000, 20072
Murphy	20000
Myryad	20081
NAD	20104
Naiko	20642
NAP	20039
Nebula Electronics	20033
NEC	20035, 20037, 20048, 20104, 20067, 20041, 20278, 21137
Neckermann	20081, 20041
Nesco	20000, 20072
Neufunk	20209, 21137
Newave	20037
Nikkai	20072, 20278
Nikko	20037
Niveus Media	21972
Noblex	20240
Nokia	20048, 20081, 20240, 20042, 20104, 20041, 20278
Nordmende	20067, 20041, 20642, 20320
Northgate	21972
Nu-Tec	20209

N

O Oceanic	20048, 20081, 20000, 20104, 20041, 20320
Okano	20209, 20072, 20278
Olympus	20035
Onimax	20642
Optimus	21062, 20162, 20037, 20048, 20104, 20593
Orbit	20072
Orion	20121, 20209, 20742
Orson	20000
Osaki	20037, 20000, 20072
Osume	20072
Otake	20209
Otto Versand	20081
P Pacific	20000, 20642, 20742
Packard Bell	21972
Palladium	20037, 20209, 20041, 20072
Palsonic	20000, 20072, 20642
Panasonic	21062, 20035, 20162, 21562, 20616, 20836, 20837
Pathe Cinema	20043
Pathe Marconi	20041
Penney	20035, 20037, 20240, 20042
Pentax	20042
Perdio	20000, 20209
Philco	20035, 20000, 20209, 20072
Philips	20035, 20081, 20000, 20593, 20739
Phoenix	20278
Phonola	20081
Pilot	20037
Pioneer	20162, 20081, 20042, 20067
Polk Audio	20081
Portland	20278
Presidian	21593
Prinz	20000
Pro Vision	20278
Profitronic	20081, 20240
Proline	20000, 20278, 20642, 20320
Proscan	20060, 20202
Proscro	20278
Prosonic	20209, 20278
Protech	20081, 20072
Pulsar	20039
Pye	20081, 20000
Q Qisheng	20060
Quasar	20035, 20162, 20278
Quelle	20081
R Radialva	20037, 20048, 20081, 20072
Radiola	20081
Radionette	20037, 21137
RadioShack	20037, 20000
Radix	20037

Randex	20037
Rank	20041
Rank Arena	20041
RCA	20060, 20035, 20048, 20240, 20000, 20042, 20320, 20202, 20880
Realistic	20035, 20037, 20048, 20047, 20000, 20104
ReplayTV	20616
Rex	20041
RFT	20072
Ricavision	21972
Rio	21137
Roadstar	20037, 20081, 20240, 20072, 20278, 20742
Royal	20072
Runco	20039
S Saba	20041, 20278, 20320
Saisho	20209
Salora	20104, 20043
Sampo	20037, 20048
Samsung	20240, 20045, 20742
Sanky	20048, 20039
Sansei	20048
Sansui	20000, 20067, 20209, 20041, 20072
Sanyo	20048, 20047, 20240, 20104, 20067, 21137
Saville	20240, 20278
SBR	20081
ScanSonic	20240
Sceptre	20104
Schaub Lorenz	20000, 20104, 20041
Schneider	20037, 20081, 20240, 20000, 20042, 20072, 20278, 20642, 21137
Scott	20045, 20121, 20043, 20593
Sears	20035, 20037, 20047, 20000, 20042, 20104
Seaway	20278
SEG	20081, 20240, 20072, 20278, 20642, 20593
SEI	20081
Sei-Sinudyne	20081
Seleco	20037, 20041
Semivox	20045, 20209
Semp	20045
Semp Toshiba	20045
Sentra	20072
Setron	20072
Sharp	20037, 20048, 20209, 20848, 21137
Shinco	20000
Shintom	20104, 20072
Shivaki	20037
Shogun	20240

S

Siemens	20037, 20081, 20104, 20320
Siera	20081
Signature	20035
Silva	20037
Silva Schneider	21137
Silver	20278
SilverCrest	20642
Singer	20045, 20072
Sinudyne	20081, 20209
Sonic Blue	20616, 21137
Sonneclair	20072
Sonolor	20048
Sontec	20037, 20278
Sonwa	20642
Sony	20035, 20032, 20033, 20000, 21032, 21972
Soundwave	20037, 20209
SR Standard	20278
Ssangyong	20072
Stack 9	21972
Stern	20278
STS	20042
Sunkai	20209, 20278
Sunstar	20000
Suntronic	20000
Sunwood	20072
Supra	20037, 20278
Sylvania	20035, 20081, 20000, 20043, 20593, 21593
Symphonic	20000, 20593, 21593
Systemax	21972
T T+A	20162
Tagar Systems	21972
Taisho	20209
Tandberg	20278
Tandy	20000, 20104
Tashiko	20037, 20048, 20081, 20240, 20000
Tatung	20048, 20081, 20045, 20000, 20067, 20043, 20209, 20041, 20742
Teac	20037, 20000, 20041, 20072, 20278, 20642, 20593, 21593
Tec	20072
Tech Line	20072
Technics	20035, 20162, 20081
Teco	20035, 20037, 20048, 20041
Tedex	20037, 20209, 20642
Teknika	20035, 20037, 20000
Teleavia	20041
Telefunken	20209, 20041, 20278, 20642, 20320, 20593
Telestar	20037
Teletech	20000, 20072, 20278
Tenosal	20072

Tensai	20037, 20000, 20072, 20278
Tesla	20081
Tevion	20209, 20642
Texet	20278
Thomas	20000
Thomson	20060, 20067, 20041, 20278, 20320, 20202
Thorn	20037, 20104, 20041
TiVo	20739
TMK	20240
Tokai	20037, 20104, 20041, 20072
Toshiba	20081, 20045, 20042, 20067, 20043, 20209, 20041, 20742, 21972
Totevision	20037, 20240
Touch	21972
Towada	20072
Toyoda	20278
Tradex	20081
Triad	20278
U Uher	20240
Ultravox	20278
Unitech	20240
United	20742, 21593
Universum	20037, 20081, 20240, 20000, 20104, 20209, 21137
V Vector	20045
VIA Technologies	21972
Victor	20067, 20041
Video Concepts	20045
Video Technic	20000
Videomagic	20037
Videosonic	20240
Viewsonic	21972
Villain	20000
Voodoo	21972
W Wards	20060, 20035, 20048, 20039, 20047, 20081, 20033, 20240, 20045, 20000, 20042, 20072
Watson	20081, 20642
Weltblick	20037
Wharfedale	20642, 20593
White Westinghouse	20209, 20072, 20278
X XR-1000	20035, 20000, 20072
Y Yamaha	20041
Yamishi	20072, 20278
Yokan	20072
Yoko	20037, 20240, 20072
Yoshita	20072
Z Zenith	20037, 20039, 20033, 20000, 20209, 21137
ZT Group	21972
ZX	20209

PVR	
A	
ABS	21972
Alienware	21972
C	
CyberPower	21972
D	
Dell	21972
DirecTV	20739
G	
Gateway	21972
H	
Hewlett Packard	21972
Howard Computers	21972
Humax	20739
Hush	21972
I	
iBUYPOWER	21972
L	
Linksys	21972
M	
Media Center PC	21972
Microsoft	21972
Mind	21972
N	
Niveus Media	21972
Northgate	21972
P	
Panasonic	20616
Philips	20739
R	
RCA	20880
ReplayTV	20616
S	
Sonic Blue	20616
Sony	21972
Stack 9	21972
Systemax	21972
T	
Tagar Systems	21972
TiVo	20739
Toshiba	21972
Touch	21972
V	
Viewsonic	21972
Voodoo	21972
Z	
ZT Group	21972

SAT/PVR Combination

D	DirecTV	20739
----------	---------	-------

TV/VCR Combination

A		
Aiwa	20000, 20742, 21137	
America Action	20278	
Amstrad	20000	
Audiovox	20278	
B		
Bestar	20278	
Blue Sky	20278, 20742	
Broksonic	20742	
Bush	20742	
C		
Citizen	20278	
Colt	20072	
Curtis Mathes	20035	

D		
Daewoo	20278	
Dantax	20742	
E		
Emerson	20278, 20593	
F		
Ferguson	20000, 20278, 20742	
Fidelity	20000	
Firstline	20278	
Funai	20000, 20593	
G		
GE	20060, 20035, 20048, 20240	
GoldStar	20037	
Goodmans	20278, 20742	
Gradiente	21137	
Grandin	20278, 20742	
Grundig	20081, 20742	
Harley Davidson	20000	
H		
Hitachi	20000, 20593	
Hypson	20037	
I		
Internal	20278	
J		
JBL	20278	
K		
Kambrook	20037	
Kneissel	20278	
L		
LG	20037	
Lloyd's	20000	
Loewe	20037	
M		
Magnasonic	20278, 20593	
Magnavox	20081, 20000, 20593	
Magnin	20240	
Matsui	20742	
Memorex	20162, 20037	
MGA	20240	
Mitsubishi	20048, 20081, 20043	
O		
Optimus	20162, 20593	
Orion	20742	
P		
Pacific	20742	
Palsonic	20000	
Panasonic	20035, 20162	
Penney	20035, 20037, 20240	
Philips	20081	
Q		
Quasar	20035, 20162	
R		
Radiola	20081	
RadioShack	20000	
RCA	20060, 20035, 20048, 20240	
Roadstar	20742	
Audiovox	20278	
Saba	20320	
S		
Samsung	20240, 20742	
Sansui	20000	
Sanyo	20240	
Schneider	20081, 20000	
Sears	20037, 20000	
Sharp	20037, 20048	
Shivaki	20037	
Siemens	20081	

Sony	20032, 20000	
Sylvania	20081, 20593	
Symphonic	20000, 20593	
T		
Tatung	20742	
Teac	20037, 20000, 20642, 20593	
Technics	20081	
Telefunken	20278	
Thomas	20000	
Thomson	20278	
Toshiba	20742	
U		
United	20742	
W		
White Westinghouse	20278	
Z		
Zenith	20000	

BD/DVD group (3****)

DVD

3D LAB	30539	
A		
Accurian	30675	
Acoustic Solutions	30730, 30713, 32082	
AEG	30770, 30790, 30675, 31233, 32173	
Afreey	30698	
Aim	30672	
Airis	30672, 31107	
Aiwa	30533, 30641	
Akai	30770, 30695, 30790, 30675, 30884, 31233	
Akura	31233, 31383	
Alba	30672, 30539, 30717, 30695, 30730, 30713, 30884	
Alco	30790	
Amitech	30770, 32187	
Amstrad	30770, 30790, 30713, 32139	
AMW	30872	
Ansonic	30831	
Apex Digital	30672, 30717, 30796, 31061	
Aristona	30539, 30646	
Arrgo	31023	
ASDA	32213	
Audio Authority	32555	
Audiosonic	31383	
Audiovox	30717, 30790	
Audioworld	30790	
Audix	30713	
Autovox	30713	
AVideo	32173	
Awa	30730, 30872, 32587	
Axil	32139	
Axion	30730	

B		
Basic Line	30713	
Bel Canto Design	31571	
Belson	32139	
Berthen	31643	
Best Buy	32139	
Black Diamond	30713, 30884	
Blaupunkt	30717	
Blu:sens	31233	
Blue Parade	30571	
Blue Sky	30672, 30651, 30695, 30790, 30713, 30884, 32623	
Brainwave	30770	
Brandt	30503, 30651, 30551	
Broksonic	30695	
Bush	30672, 30717, 30730, 30831, 30713, 30884, 31383	
Byd:sign	30872	
C		
California Audio Labs	30490	
CCE	30730	
Centrex	30672	
Centrum	30675, 30713	
Changhong	30627, 31061	
Cinea	30831	
Cineral	30730	
Cinetec	30713, 30872	
Citizen	30695	
CJ Digital	31643, 32173	
Classic	30730	
Clatronic	30672, 30675, 31233	
Clayton	30713	
CMX	31643	
Coby	30730, 31107, 31628, 32494	
Codex	31233	
Compacts	31107	
Conia	30672	
Contel	32331	
Continental Edison	30831, 30872	
Craig	30831	
Crown	30770, 30713	
Cybercom	30831	
CyberHome	31023	
Cytron	30651	
D		
Daenyx	30872	
Daewoo	30770, 30872, 32187	
Dansai	30770	
Dantax	30539, 30790, 30713	
Datsun	31233	
Daytek	30872	
Dayton Audio	30872	
DCE	30831	
Decca	30770	
Denon	30490, 31634, 32258, 32748, 33698	

Denver	30672, 31107	
Dgtec	30672	
Diamond	30651, 30790	
Dicra	32173	
Digihome	30713	
DigiLogic	30713	
digitRED	30717	
Digital	32173	
DigitalMax	31738	
Digitor	30651	
Digitrex	30672	
DiK	30831	
Disney	30831, 30675, 31270	
DK Digital	30831, 31643, 32095	
DMTech	32173, 32187	
Dragon	30831	
DSE	30675, 32095	
Dual	30651, 30730, 30831, 30790, 30713, 30884, 31023	
Durabrand	30831, 30675, 30713, 31023	
DVS	30672	
Dynex	32596	
E		
E:max	30770, 31233, 31643	
ECC	30730	
Elfunk	30713, 30884	
Elin	30770	
Elite	32854	
Elta	30672, 30770, 31233, 31643, 32173	
Eltax	31233	
Emerson	30675, 32213	
Encore	30698	
EuroLine	30675, 31233, 31643	
Fenner	30651	
F		
Ferguson	30651, 30695, 30713, 30884	
Finlux	30672, 30741, 30770	
Firstline	30713	
Funai	30695, 30675	
G		
G-Hanz	32213	
G-HanzS	32213	
GE	30522, 30717	
GFM	30675	
Go Video	30744, 30741, 31044, 31075	
GoldStar	30741	
Goodmans	30651, 30730, 30790, 30713, 30884, 31383	
GoWell	31643	
GPX	30741	
Gradiente	30651	
Gran Prix	30831	
Grandin	30713, 31233, 32173	
Greenhill	30717	

Grundig	30539, 30651, 30551, 30695, 30790, 30713, 31643
Grunkel	30770, 30831, 30790
GVG	30770
H	
H & B	30713, 31233, 32173
Hanseatic	30741, 30790
Harman/Kardon	31229, 32927
HE	30730
Hello Kitty	30831
Henss	30713
Hikona	31383
Hitachi	30573, 30664, 30695, 30713, 30884
Hitech	33523
Hiteker	30672
Höher	30651, 30831, 30713, 31643, 32173
Home Electronics	30770, 30730
Home Tech Industries	31107, 31643
Humax	30646
HYD	31233
Hyundai	31061
I	
Ileki	31107
Ingersoll	31023
Initial	30717
Inno Hit	30713
Insignia	30741, 30675, 32095, 32428, 32596
Integra	30571, 30627, 31634, 31769, 32147
Irradio	30646, 31233
ISP	30695
it's	30717
ITT	31233
J	
JDB	30730
JMB	30695
JNC	30672
JVC	30503, 30539, 30623, 30867, 31164, 31602, 32365, 32855
jWin	30672
K	
Kansai	31107
Kansas Technologies	31233
Kawasaki	30790
Kendo	30672, 30831, 30713
Kennex	30770, 30713
Kenwood	30490, 30534
KeyPlug	31643
Kiuro	30770
King D'Home	30796
King Vision	31643
KLH	30717, 30790
Koss	30651
KXD	31107

L	
Lazer	32173
Leiker	30872
Lenco	30651, 30770, 30713, 31383
Lexicon	32545
LG	30741, 30790, 31233, 31602
Lifetec	30651, 30831
LiteOn	31738
LM	31643
Lodos	30713, 30884
Loewe	30539, 30741
Logik	30713, 30884, 32594
Logitech	32639
Lumatron	30741, 30695, 30713
Lunatron	30741
Luxman	30573
Luxor	30717, 30713, 30884
M	
Magnasonic	30651
Magnavox	30503, 30539, 30646, 30675, 30713, 31354, 31506
Magnum	31382
Majestic	31107
Manhattan	30713
Marantz	30539, 31627, 32414
Mark	30713
Marquant	30770, 31628
Matsui	30672, 30651, 30695, 30713, 30884
Maxim	30713, 30872
MBO	30730
McIntosh	31533
MDS	30713
Mecotek	30770
Medion	30651, 30630, 30741, 30831, 31107, 31270
MEI	30790
Memorex	30695, 30831, 31270, 32213, 32331, 33153
Memory	31383
Metz	30571, 30713
Micromaxx	30695
Micromedia	30503, 30539
Micromega	30539
Microsoft	30522
Microstar	30831
Minax	30713
Minoka	30770
Mintek	30717
Miray	33506
Mitsubishi	31521, 30713, 33133
Mizuda	30770
Mustek	30730
Muvid	31643, 32173
Mx Onda	30651, 31383

N	
NAD	30741
Naiko	30770
NEC	30741, 30785, 31602
Neom	31643
Nesa	30717
Nevir	30672, 30770, 30831
Nexius	30790
Noblex	31233
Norcent	30872, 31107
Nordmende	30831
Nortek	31643, 32173
O	
Ölevia	32331
Olidata	30672
Omni	30698
One For All	32555
Onkyo	30503, 30627, 31627, 31769, 32147, 32562
Oppo	32545
Orbit	30872, 31643
Orion	30695, 30713, 31233
Oritron	30651
Ormond	30713
Otic	31383
P	
Pacific	30831, 30790, 30713
Packard Bell	30831
Palladium	30695, 30713
Palsonic	30672
Panasonic	30503, 30490, 31579, 31641, 31762, 32523, 32710, 32859, 33641, 33944, 33949
Panda	30717, 31107
Pelican Accessories	30533
Philco	30790, 30675
Philips	30503, 30539, 30646, 30675, 30713, 31267, 31340, 31354, 31506, 32056, 32084, 32334, 32434, 32789, 32791
Pioneer	30571, 30142, 30631, 31531, 31571, 32442, 32854
Play It	31643
Polaroid	31061
Polk Audio	30539
Portland	30770
Powerpoint	30872
Presidian	30675, 31738
Prinz	30831
Prism	30831
PrivateLabel	32616
Pro Vision	30730, 31107
Proceed	30672
Proline	30672, 30651, 31643, 31738, 32082, 32616
Proscan	30522
Proson	30713

Prosonic	32082, 32187
Pye	30539, 30646
Q	
QONIX	30790
Qwestar	30651
R	
Radionette	30741
Radiotone	30713
RCA	30522, 30571, 30717, 30790, 30822, 31769, 32213, 32587, 32592, 32594
RE-BL	32555
REC	30490
Recco	30698
Red	32213
Red Star	30770, 31107
Richmond	31233
Roadstar	30672, 30730, 30713
Ronin	30872
Rotel	30623
Rowa	30717, 30872
S	
Saba	30651, 30551, 31643, 32173
Saivod	30831
Salora	30741
Sampo	30698
Samsung	30490, 30573, 30744, 33195, 32951, 32942, 32843, 32556, 32489, 32329, 32107, 32069, 31635, 31470, 31075, 31044, 30820, 30199
Sansui	30695, 32082
Sanyo	30695, 30713
ScanMagic	30730
Schaub Lorenz	30770, 31643, 32173
Schneider	30539, 30646, 30651, 30831, 30790, 30713
Schöntech	30713
Scott	30672, 30651, 31233, 31383, 32173
Seeltech	31643
SEG	30713, 30872, 30884
Semp	30503
Shanghai	30672
Sharp	30630, 30675, 30713, 32250, 32479, 32652, 33313, 33314
Sherwood	30717, 30741, 30770, 31043
Shinco	30717
Shinsonic	30533
Siemssen	31382
Sigmathek	32139
Silva Schneider	30741, 30831
SilverCrest	32173
Systemas	30672
Skantic	30539, 30713
Skymaster	30730
SM Electronic	30730
Smart	30713

Sogo	30672
Sonashi	30831
Soniq	30831
Sontech	31383
Sony	30533, 31533, 30864, 30772, 31033, 31070, 31431, 31516, 31536, 31633, 32132, 32178, 32180, 32504, 33519, 33939
Sound Color	31233
Soundwave	30713
Spectra	30872
SR Standard	30651, 30831
Strato	31382
Strong	30713
Sunkai	30770
Sunstech	30831, 32139
Superior	31643, 32173
Supersonic	33946
Supratech	32139
SVA	30672, 30717
Swisstec	32187
Sylvania	30630, 30675
Symphonic	30675
Sytech	30831, 32139
T	
Tandberg	30713
Targa	30741
Tatung	30770
TBoston	32139
Tchibo	30741
TCL	32587
TCM	30741, 30790
Teac	30571, 30717, 30741, 30790, 30675, 31383, 32139
Technica	30713, 30884
Technics	30490
Technika	30770, 30831, 31383, 32187
Technisson	30672
Technosonic	30730
TechnoStar	31643
Techwood	30713
TELE System	32173
Telefunken	30551, 30790
Teletech	30713, 30884
Tensai	30651, 30770
Tevion	30651, 31382
Theta Digital	30571
Thomson	30522, 30551, 30831
Thule Audio	30551
Tokai	30790, 30698, 31233
Tokaido	30698
Toshiba	30503, 30695, 31154, 31510, 31769, 32006, 32277, 32551, 32705, 33157
TRANS-continents	30831, 30872, 31233

Trasonic	30730
Trent	31643
Trevi	30831
TVE	30713
U UMC	32187
United	30695, 30730, 30675, 30713, 30884, 31233, 31383, 31643
Universum	30741, 30790, 30713
Urban Concepts	30503
V Venturer	30790, 31769, 32082
Vestel	30713, 30884
Viore	32553
Vizio	32563
Voxson	30730, 30831
Vtrek	32587
W Waitec	30730, 31233
Walkvision	30717
Waltham	30713
WB Electronics	32555
Welkin	30831
Wellington	30713
Weltstar	30713
Wharfedale	30790, 30698, 30713, 31383
Wilson	30831, 31233
Windsor	30713
Windy Sam	30573
Woxter	32139
X X-View	31233
Xbox	30522
Xenius	30790
Xiron	31383
XMS	30770
Y Yamada	30872, 32139
Yamaha	30490, 30539, 30646, 30545, 30817, 31354, 32298, 32558
Yamakawa	30872
YBA	30872
Yukai	30730
Z Zenith	30503, 30741

Blu-ray Disc

D Denon	32258, 32748, 33698
E Elite	32854
F Funai	30675
H Harman/Kardon	32927
I Insignia	30675, 32428, 32596
Integra	32147
J JVC	32365, 32855
L Lexicon	32545
LG	30741, 31602
M Magnavox	30675
Marantz	32414

Memorex	32331
Mitsubishi	33133
O Ölevia	32331
Onkyo	32147, 32562
Oppo	32545
P Panasonic	31641, 32523, 32710, 32859, 33641, 33944, 33949
Philips	32084, 32434, 32789
Pioneer	30142, 32442, 32854
S Samsung	30199, 32951, 33195
Sharp	32250, 32479, 32652, 33313, 33314
Sony	31516, 32178, 32180, 32504, 33519, 33939
Sylvania	30675
T Toshiba	32551, 32705, 33157
V Viore	32553
Vizio	32563
Y Yamaha	32298

DVD-R

A Accurian	30675
Aristona	30646
D Denon	30490
DigitalMax	31738
E Emerson	30675
F Funai	30675
G Go Video	30741
GPX	30741
H Humax	30646
I Irradio	30646
J JVC	31164
L LG	30741
LiteOn	31738
Loewe	30741
M Magnavox	30646, 30675, 31506
Medion	30741
Mitsubishi	33133
P Panasonic	30490, 31579, 32523, 32710, 32859, 33944, 33949
Philips	30646, 31340, 31506
Pioneer	30631
Presidian	31738
Proline	31738
Pye	30646
R RCA	30522
S Samsung	30490, 31470, 31635, 32107, 32489, 32942
Schneider	30646
Sharp	30630, 30675, 32479, 33313, 33314
Sony	31033, 31070, 31431, 31516, 31536, 31633, 32132, 32178, 32180, 33519, 33939
Sylvania	30675

T Targa	30741
Thomson	30551
Toshiba	31510, 32277, 32551
Y Yamaha	30646
Z Zenith	30741

HD-DVD

I Integra	31769
L LG	30741
O Onkyo	31769
R RCA	31769
T Toshiba	31769

TV/DVD Combination

A Acoustic Solutions	32082
Akai	30695
Akura	31383
Alba	30695, 30884
Audiosonic	31383
B Black Diamond	30713, 30884
Blue Sky	30713, 30884
Broksonic	30695
Bush	30713, 30884, 31383
C Centrum	30713
Citizen	30695
Crown	30713
D Dual	30713, 30884
E Elfunk	30713, 30884
Emerson	30675
F Ferguson	30695, 30713, 30884
G Goodmans	30713, 30884, 31383
Grandin	30713
Grundig	30539, 30695
H Hikona	31383
Hitachi	30713, 30884
L Lenco	31383
Logik	30713, 30884
Luxor	30713, 30884
M Matsui	30713, 30884
Memory	31383
Mx Onda	31383
O Orion	30695
Otic	31383
P Philips	30539
Proline	32082
Prosonic	32082
S Sansui	30695, 32082
Scott	31383
SEG	30713, 30884
Sontech	31383

Supersonic	33946
Sylvania	30630, 30675
T Teac	31383
Technica	30713, 30884
Technika	31383
Teletch	30713, 30884
Thomson	30551
Toshiba	30695
U United	30713, 30884, 31383
Universum	30713
V Venturer	32082
Vestel	30884
W Weltstar	30713
Wharfedale	31383
X Xiron	31383

TV/CDR/DVD Combination

F Ferguson	30695
M Matsui	30695
S Sharp	30630

Audio group (4 * * * *)

CD

A Acoustic Research	40420
Advantage	40032
AH!	40157
Aiwa	40157
Arcam	40157
Atoll Electronique	40157
Audio Research	40157
Audiolab	40157
Audiomeca	40157
Audioton	40157
AVI	40157
B Balanced Audio Technology	40157
Burmester	40420
C Caim	40157
California Audio Labs	40029, 40303
Cambridge	40157
Cambridge Audio	40157
Carver	40157
CCE	40157
CDC	40420
CEC	40420
Cyrus	40157
D Denon	40626, 40003, 42867, 42868
DKK	40000

DMX Electronics	40157
Dual	40003
Dynaco	40157
G Garrard	40420
Genexxa	40000, 40032
Goldmund	40157
Grundig	40157
H Harman/Kardon	40157, 40173
Hitachi	40032
I Inkel	40180
Integra	40101
J JVC	40072
K Kenwood	40626, 40157, 40028, 40036
Krell	40157
L Linn	40157
Loewe	40157
Lyngdorf	42766
M Magnavox	40157
Marantz	40626, 40029, 40157, 40180
Matsui	40157
MCS	40029
Memorex	40032, 40180
Meridian	40157
Micromega	40157
Miro	40000
Mission	40157
MTC	40420
Myryad	40157
N NAD	40000
Naim	40157
NSM	40157
O Onkyo	40101
Optimus	40000, 40032, 40420
P Panasonic	40029, 40303, 40752
Parasound	40420
Philips	40626, 40157
Pioneer	40032, 40101
Polk Audio	40157
Primare	40157
Proceed	40420
Proton	40157
Q QED	40157
Quad	40157
Quasar	40029
R Radiola	40157
RCA	40032, 40420
Realistic	40180, 40420
Restek	40157
Revox	40157
Roksan	40420
Rotel	40157, 40420

	Royal	40420
S	SAE	40157
	Sansui	40157
	SAST	40157
	Sharp	40180
	Sherwood	40180
	Siemens	40157
	Silsonic	40036
	Simaudio	40157
	Sonic Frontiers	40157
	Sony	40490, 40000, 41364, 40185
	Sylvania	40157
T	TAG McLaren	40157
	Tandy	40032
	Tangent	43304
	Tascam	40420
	Teac	40180, 40420
	Technics	40029, 40303
	Thorens	40157
	Thule Audio	40157
	Tokai	40420
	Traxdata	40626
U	Universum	40157
V	Victor	40072
W	Wards	40000, 40032, 40157
Y	Yamaha	40490, 40032, 40036
Z	Zonda	40157

CD-R

D	Denon	40626, 42868
J	JVC	40072
K	Kenwood	40626
M	Marantz	40626
P	Philips	40626
R	RCA	40420
S	Sony	40000, 41364
T	Teac	40420

License

This section describes software license used for this unit. To maintain the correct content, the original (English) is used.

Boost

<http://www.boost.org/>

Boost Software License - Version 1.0 - August 17th, 2003

Permission is hereby granted, free of charge, to any person or organization obtaining a copy of the software and accompanying documentation covered by this license (the "Software") to use, reproduce, display, distribute, execute, and transmit the Software, and to prepare derivative works of the Software, and to permit third-parties to whom the Software is furnished to do so, all subject to the following:

The copyright notices in the Software and this entire statement, including the above license grant, this restriction and the following disclaimer, must be included in all copies of the Software, in whole or in part, and all derivative works of the Software, unless such copies or derivative works are solely in the form of machine-executable object code generated by a source language processor.

THE SOFTWARE IS PROVIDED "AS IS", WITHOUT WARRANTY OF ANY KIND, EXPRESS OR IMPLIED, INCLUDING BUT NOT LIMITED TO THE WARRANTIES OF MERCHANTABILITY, FITNESS FOR A PARTICULAR PURPOSE, TITLE AND NON-INFRINGEMENT. IN NO EVENT SHALL THE COPYRIGHT HOLDERS OR ANYONE DISTRIBUTING THE SOFTWARE BE LIABLE FOR ANY DAMAGES OR OTHER LIABILITY, WHETHER IN CONTRACT, TORT OR OTHERWISE, ARISING FROM, OUT OF OR IN CONNECTION WITH THE SOFTWARE OR THE USE OR OTHER DEALINGS IN THE SOFTWARE.

Expat

<http://www.jclark.com/xml/expat.html>

Expat License. Copyright (c) 1998, 1999, 2000 Thai Open Source Software Center Ltd

Permission is hereby granted, free of charge, to any person obtaining a copy of this software and associated documentation files (the "Software"), to deal in the Software without restriction, including without limitation the rights to use, copy, modify, merge, publish, distribute, sublicense, and/or sell copies of the Software, and to permit persons to whom the Software is furnished to do so, subject to the following conditions:

The above copyright notice and this permission notice shall be included in all copies or substantial portions of the Software.

THE SOFTWARE IS PROVIDED "AS IS", WITHOUT WARRANTY OF ANY KIND, EXPRESS OR IMPLIED, INCLUDING BUT NOT LIMITED TO THE WARRANTIES OF MERCHANTABILITY, FITNESS FOR A PARTICULAR PURPOSE AND NON-INFRINGEMENT. IN NO EVENT SHALL THE AUTHORS OR COPYRIGHT HOLDERS BE LIABLE FOR ANY CLAIM, DAMAGES OR OTHER LIABILITY, WHETHER IN AN ACTION OF CONTRACT, TORT OR OTHERWISE, ARISING FROM, OUT OF OR IN

CONNECTION WITH THE SOFTWARE OR THE USE OR OTHER DEALINGS IN THE SOFTWARE.

FastDelegate

<http://www.codeproject.com/KB/cpp/FastDelegate.aspx>

THE WORK (AS DEFINED BELOW) IS PROVIDED UNDER THE TERMS OF THIS CODE PROJECT OPEN LICENSE ("LICENSE"). THE WORK IS PROTECTED BY COPYRIGHT AND/OR OTHER APPLICABLE LAW. ANY USE OF THE WORK OTHER THAN AS AUTHORIZED UNDER THIS LICENSE OR COPYRIGHT LAW IS PROHIBITED.

BY EXERCISING ANY RIGHTS TO THE WORK PROVIDED HEREIN, YOU ACCEPT AND AGREE TO BE BOUND BY THE TERMS OF THIS LICENSE. THE AUTHOR GRANTS YOU THE RIGHTS CONTAINED HEREIN IN CONSIDERATION OF YOUR ACCEPTANCE OF SUCH TERMS AND CONDITIONS. IF YOU DO NOT AGREE TO ACCEPT AND BE BOUND BY THE TERMS OF THIS LICENSE, YOU CANNOT MAKE ANY USE OF THE WORK.

1. Definitions.

- a. "Articles" means, collectively, all articles written by Author which describes how the Source Code and Executable Files for the Work may be used by a user.
- b. "Author" means the individual or entity that offers the Work under the terms of this License.
- c. "Derivative Work" means a work based upon the Work or upon the Work and other pre-existing works.
- d. "Executable Files" refer to the executables, binary files, configuration and any required data files included in the Work.
- e. "Publisher" means the provider of the website, magazine, CD-ROM, DVD or other medium from or by which the Work is obtained by You.
- f. "Source Code" refers to the collection of source code and configuration files used to create the Executable Files.
- g. "Standard Version" refers to such a Work if it has not been modified, or has been modified in accordance with the consent of the Author, such consent being in the full discretion of the Author.
- h. "Work" refers to the collection of files distributed by the Publisher, including the Source Code, Executable Files, binaries, data files, documentation, whitepapers and the Articles.
- i. "You" is you, an individual or entity wishing to use the Work and exercise your rights under this License.

2. Fair Use/Fair Use Rights. Nothing in this License is intended to reduce, limit, or restrict any rights arising from fair use, fair dealing, first sale or other limitations on the exclusive rights of the copyright owner under copyright law or other applicable laws.

3. License Grant. Subject to the terms and conditions of this License, the Author hereby grants You a worldwide, royalty-free, non-exclusive, perpetual (for the duration of the applicable copyright) license to exercise the rights in the Work as stated below:

- a. You may use the standard version of the Source Code or Executable Files in Your own applications.
- b. You may apply bug fixes, portability fixes and other modifications obtained from the Public Domain or from the Author. A Work modified in such a way shall still be considered the standard version and will be subject to this License.

c. You may otherwise modify Your copy of this Work (excluding the Articles) in any way to create a Derivative Work, provided that You insert a prominent notice in each changed file stating how, when and where You changed that file.

d. You may distribute the standard version of the Executable Files and Source Code or Derivative Work in aggregate with other (possibly commercial) programs as part of a larger (possibly commercial) software distribution.

e. The Articles discussing the Work published in any form by the author may not be distributed or republished without the Author's consent. The author retains copyright to any such Articles. You may use the Executable Files and Source Code pursuant to this License but you may not repost or republish or otherwise distribute or make available the Articles, without the prior written consent of the Author.

Any subroutines or modules supplied by You and linked into the Source Code or Executable Files this Work shall not be considered part of this Work and will not be subject to the terms of this License.

4. Patent License. Subject to the terms and conditions of this License, each Author hereby grants to You a perpetual, worldwide, non-exclusive, no-charge, royalty-free, irrevocable (except as stated in this section) patent license to make, have made, use, import, and otherwise transfer the Work.

5. Restrictions. The license granted in Section 3 above is expressly made subject to and limited by the following restrictions:

- a. You agree not to remove any of the original copyright, patent, trademark, and attribution notices and associated disclaimers that may appear in the Source Code or Executable Files.
- b. You agree not to advertise or in any way imply that this Work is a product of Your own.
- c. The name of the Author may not be used to endorse or promote products derived from the Work without the prior written consent of the Author.
- d. You agree not to sell, lease, or rent any part of the Work. This does not restrict you from including the Work or any part of the Work inside a larger software distribution that itself is being sold. The Work by itself, though, cannot be sold, leased or rented.
- e. You may distribute the Executable Files and Source Code only under the terms of this License, and You must include a copy of, or the Uniform Resource Identifier for, this License with every copy of the Executable Files or Source Code You distribute and ensure that anyone receiving such Executable Files and Source Code agrees that the terms of this License apply to such Executable Files and/or Source Code. You may not offer or impose any terms on the Work that alter or restrict the terms of this License or the recipients' exercise of the rights granted hereunder. You may not sublicense the Work. You must keep intact all notices that refer to this License and to the disclaimer of warranties. You may not distribute the Executable Files or Source Code with any technological measures that control access or use of the Work in a manner inconsistent with the terms of this License.
- f. You agree not to use the Work for illegal, immoral or improper purposes, or on pages containing illegal, immoral or improper material. The Work is subject to

applicable export laws. You agree to comply with all such laws and regulations that may apply to the Work after Your receipt of the Work.

6. Representations, Warranties and Disclaimer. THIS WORK IS PROVIDED "AS IS", "WHERE IS" AND "AS AVAILABLE", WITHOUT ANY EXPRESS OR IMPLIED WARRANTIES OR CONDITIONS OR GUARANTEES. YOU, THE USER, ASSUME ALL RISK IN ITS USE, INCLUDING COPYRIGHT INFRINGEMENT, PATENT INFRINGEMENT, SUITABILITY, ETC. AUTHOR EXPRESSLY DISCLAIMS ALL EXPRESS, IMPLIED OR STATUTORY WARRANTIES OR CONDITIONS, INCLUDING WITHOUT LIMITATION, WARRANTIES OR CONDITIONS OF MERCHANTABILITY, MERCHANTABLE QUALITY OR FITNESS FOR A PARTICULAR PURPOSE, OR ANY WARRANTY OF TITLE OR NON-INFRINGEMENT, OR THAT THE WORK (OR ANY PORTION THEREOF) IS CORRECT, USEFUL, BUG-FREE OR FREE OF VIRUSES. YOU MUST PASS THIS DISCLAIMER ON WHENEVER YOU DISTRIBUTE THE WORK OR DERIVATIVE WORKS.

7. Indemnity. You agree to defend, indemnify and hold harmless the Author and the Publisher from and against any claims, suits, losses, damages, liabilities, costs, and expenses (including reasonable legal or attorneys' fees) resulting from or relating to any use of the Work by You.

8. Limitation on Liability. EXCEPT TO THE EXTENT REQUIRED BY APPLICABLE LAW, IN NO EVENT WILL THE AUTHOR OR THE PUBLISHER BE LIABLE TO YOU ON ANY LEGAL THEORY FOR ANY SPECIAL, INCIDENTAL, CONSEQUENTIAL, PUNITIVE OR EXEMPLARY DAMAGES ARISING OUT OF THIS LICENSE OR THE USE OF THE WORK OR OTHERWISE, EVEN IF THE AUTHOR OR THE PUBLISHER HAS BEEN ADVISED OF THE POSSIBILITY OF SUCH DAMAGES.

9. Termination.

- a. This License and the rights granted hereunder will terminate automatically upon any breach by You of any term of this License. Individuals or entities who have received Derivative Works from You under this License, however, will not have their licenses terminated provided such individuals or entities remain in full compliance with those licenses. Sections 1, 2, 6, 7, 8, 9, 10 and 11 will survive any termination of this License.
 - b. If You bring a copyright, trademark, patent or any other infringement claim against any contributor over infringements You claim are made by the Work, your License from such contributor to the Work ends automatically.
 - c. Subject to the above terms and conditions, this License is perpetual (for the duration of the applicable copyright in the Work). Notwithstanding the above, the Author reserves the right to release the Work under different license terms or to stop distributing the Work at any time; provided, however that any such election will not serve to withdraw this License (or any other license that has been, or is required to be, granted under the terms of this License), and this License will continue in full force and effect unless terminated as stated above.
10. Publisher. The parties hereby confirm that the Publisher shall not, under any circumstances, be responsible for and shall not have any liability in respect of the subject matter of this License. The Publisher makes no warranty

whatsoever in connection with the Work and shall not be liable to You or any party on any legal theory for any damages whatsoever, including without limitation any general, special, incidental or consequential damages arising in connection to this license. The Publisher reserves the right to cease making the Work available to You at any time without notice

11. Miscellaneous

- a. This License shall be governed by the laws of the location of the head office of the Author or if the Author is an individual, the laws of location of the principal place of residence of the Author.
- b. If any provision of this License is invalid or unenforceable under applicable law, it shall not affect the validity or enforceability of the remainder of the terms of this License, and without further action by the parties to this License, such provision shall be reformed to the minimum extent necessary to make such provision valid and enforceable.
- c. No term or provision of this License shall be deemed waived and no breach consented to unless such waiver or consent shall be in writing and signed by the party to be charged with such waiver or consent.
- d. This License constitutes the entire agreement between the parties with respect to the Work licensed herein. There are no understandings, agreements or representations with respect to the Work not specified herein. The Author shall not be bound by any additional provisions that may appear in any communication from You. This License may not be modified without the mutual written agreement of the Author and You

▣ libogg

<http://www.xiph.org/ogg/>

Copyright (c) 2002, Xiph.org Foundation

Redistribution and use in source and binary forms, with or without modification, are permitted provided that the following conditions are met:

- Redistributions of source code must retain the above copyright notice, this list of conditions and the following disclaimer.
- Redistributions in binary form must reproduce the above copyright notice, this list of conditions and the following disclaimer in the documentation and/or other materials provided with the distribution.
- Neither the name of the Xiph.org Foundation nor the names of its contributors may be used to endorse or promote products derived from this software without specific prior written permission.

THIS SOFTWARE IS PROVIDED BY THE COPYRIGHT HOLDERS AND CONTRIBUTORS "AS IS" AND ANY EXPRESS OR IMPLIED WARRANTIES, INCLUDING, BUT NOT LIMITED TO, THE IMPLIED WARRANTIES OF MERCHANTABILITY AND FITNESS FOR A PARTICULAR PURPOSE ARE DISCLAIMED. IN NO EVENT SHALL THE FOUNDATION OR CONTRIBUTORS BE LIABLE FOR ANY DIRECT, INDIRECT, INCIDENTAL, SPECIAL, EXEMPLARY, OR CONSEQUENTIAL DAMAGES (INCLUDING, BUT NOT LIMITED TO, PROCUREMENT OF SUBSTITUTE GOODS OR SERVICES; LOSS OF USE, DATA, OR PROFITS; OR BUSINESS INTERRUPTION) HOWEVER CAUSED AND ON

ANY THEORY OF LIABILITY, WHETHER IN CONTRACT, STRICT LIABILITY, OR TORT (INCLUDING NEGLIGENCE OR OTHERWISE) ARISING IN ANY WAY OUT OF THE USE OF THIS SOFTWARE, EVEN IF ADVISED OF THE POSSIBILITY OF SUCH DAMAGE.

▣ libvorbis

<http://www.xiph.org/vorbis/>

Copyright (c) 2002-2004 Xiph.org Foundation

Redistribution and use in source and binary forms, with or without modification, are permitted provided that the following conditions are met:

- Redistributions of source code must retain the above copyright notice, this list of conditions and the following disclaimer.
- Redistributions in binary form must reproduce the above copyright notice, this list of conditions and the following disclaimer in the documentation and/or other materials provided with the distribution.
- Neither the name of the Xiph.org Foundation nor the names of its contributors may be used to endorse or promote products derived from this software without specific prior written permission.

THIS SOFTWARE IS PROVIDED BY THE COPYRIGHT HOLDERS AND CONTRIBUTORS "AS IS" AND ANY EXPRESS OR IMPLIED WARRANTIES, INCLUDING, BUT NOT LIMITED TO, THE IMPLIED WARRANTIES OF MERCHANTABILITY AND FITNESS FOR A PARTICULAR PURPOSE ARE DISCLAIMED. IN NO EVENT SHALL THE FOUNDATION OR CONTRIBUTORS BE LIABLE FOR ANY DIRECT, INDIRECT, INCIDENTAL, SPECIAL, EXEMPLARY, OR CONSEQUENTIAL DAMAGES (INCLUDING, BUT NOT LIMITED TO, PROCUREMENT OF SUBSTITUTE GOODS OR SERVICES; LOSS OF USE, DATA, OR PROFITS; OR BUSINESS INTERRUPTION) HOWEVER CAUSED AND ON ANY THEORY OF LIABILITY, WHETHER IN CONTRACT, STRICT LIABILITY, OR TORT (INCLUDING NEGLIGENCE OR OTHERWISE) ARISING IN ANY WAY OUT OF THE USE OF THIS SOFTWARE, EVEN IF ADVISED OF THE POSSIBILITY OF SUCH DAMAGE.

▣ Tremolo

<http://wss.co.uk/pinknoise/tremolo>

Copyright (C) 2002-2009 Xiph.org Foundation Changes Copyright (C) 2009-2010 Robin Watts for Pinknoise Productions Ltd

Redistribution and use in source and binary forms, with or without modification, are permitted provided that the following conditions are met:

- Redistributions of source code must retain the above copyright notice, this list of conditions and the following disclaimer.
- Redistributions in binary form must reproduce the above copyright notice, this list of conditions and the following disclaimer in the documentation and/or other materials provided with the distribution.

- Neither the name of the Xiph.org Foundation nor the names of its contributors may be used to endorse or promote products derived from this software without specific prior written permission.

THIS SOFTWARE IS PROVIDED BY THE COPYRIGHT HOLDERS AND CONTRIBUTORS "AS IS" AND ANY EXPRESS OR IMPLIED WARRANTIES, INCLUDING, BUT NOT LIMITED TO, THE IMPLIED WARRANTIES OF MERCHANTABILITY AND FITNESS FOR A PARTICULAR PURPOSE ARE DISCLAIMED. IN NO EVENT SHALL THE FOUNDATION OR CONTRIBUTORS BE LIABLE FOR ANY DIRECT, INDIRECT, INCIDENTAL, SPECIAL, EXEMPLARY, OR CONSEQUENTIAL DAMAGES (INCLUDING, BUT NOT LIMITED TO, PROCUREMENT OF SUBSTITUTE GOODS OR SERVICES; LOSS OF USE, DATA, OR PROFITS; OR BUSINESS INTERRUPTION) HOWEVER CAUSED AND ON ANY THEORY OF LIABILITY, WHETHER IN CONTRACT, STRICT LIABILITY, OR TORT (INCLUDING NEGLIGENCE OR OTHERWISE) ARISING IN ANY WAY OUT OF THE USE OF THIS SOFTWARE, EVEN IF ADVISED OF THE POSSIBILITY OF SUCH DAMAGE.

▣ Tremor

<http://wiki.xiph.org/index.php/Tremor>

Copyright (c) 2002, Xiph.org Foundation

Redistribution and use in source and binary forms, with or without modification, are permitted provided that the following conditions are met:

- Redistributions of source code must retain the above copyright notice, this list of conditions and the following disclaimer.
- Redistributions in binary form must reproduce the above copyright notice, this list of conditions and the following disclaimer in the documentation and/or other materials provided with the distribution.
- Neither the name of the Xiph.org Foundation nor the names of its contributors may be used to endorse or promote products derived from this software without specific prior written permission.

THIS SOFTWARE IS PROVIDED BY THE COPYRIGHT HOLDERS AND CONTRIBUTORS "AS IS" AND ANY EXPRESS OR IMPLIED WARRANTIES, INCLUDING, BUT NOT LIMITED TO, THE IMPLIED WARRANTIES OF MERCHANTABILITY AND FITNESS FOR A PARTICULAR PURPOSE ARE DISCLAIMED. IN NO EVENT SHALL THE FOUNDATION OR CONTRIBUTORS BE LIABLE FOR ANY DIRECT, INDIRECT, INCIDENTAL, SPECIAL, EXEMPLARY, OR CONSEQUENTIAL DAMAGES (INCLUDING, BUT NOT LIMITED TO, PROCUREMENT OF SUBSTITUTE GOODS OR SERVICES; LOSS OF USE, DATA, OR PROFITS; OR BUSINESS INTERRUPTION) HOWEVER CAUSED AND ON ANY THEORY OF LIABILITY, WHETHER IN CONTRACT, STRICT LIABILITY, OR TORT (INCLUDING NEGLIGENCE OR OTHERWISE) ARISING IN ANY WAY OUT OF THE USE OF THIS SOFTWARE, EVEN IF ADVISED OF THE POSSIBILITY OF SUCH DAMAGE.

▣ Mersenne Twister

<http://www.math.sci.hiroshima-u.ac.jp/~m-mat/MT/MT2002/CODES/mt19937ar.c>

Copyright (C) 1997 - 2002, Makoto Matsumoto and Takuji Nishimura,
All rights reserved.

Redistribution and use in source and binary forms, with or without modification, are permitted provided that the following conditions are met:

1. Redistributions of source code must retain the above copyright notice, this list of conditions and the following disclaimer.
2. Redistributions in binary form must reproduce the above copyright notice, this list of conditions and the following disclaimer in the documentation and/or other materials provided with the distribution.
3. The names of its contributors may not be used to endorse or promote products derived from this software without specific prior written permission.

THIS SOFTWARE IS PROVIDED BY THE COPYRIGHT HOLDERS AND CONTRIBUTORS "AS IS" AND ANY EXPRESS OR IMPLIED WARRANTIES, INCLUDING, BUT NOT LIMITED TO, THE IMPLIED WARRANTIES OF MERCHANTABILITY AND FITNESS FOR A PARTICULAR PURPOSE ARE DISCLAIMED. IN NO EVENT SHALL THE COPYRIGHT OWNER OR CONTRIBUTORS BE LIABLE FOR ANY DIRECT, INDIRECT, INCIDENTAL, SPECIAL, EXEMPLARY, OR CONSEQUENTIAL DAMAGES (INCLUDING, BUT NOT LIMITED TO, PROCUREMENT OF SUBSTITUTE GOODS OR SERVICES; LOSS OF USE, DATA, OR PROFITS; OR BUSINESS INTERRUPTION) HOWEVER CAUSED AND ON ANY THEORY OF LIABILITY, WHETHER IN CONTRACT, STRICT LIABILITY, OR TORT (INCLUDING NEGLIGENCE OR OTHERWISE) ARISING IN ANY WAY OUT OF THE USE OF THIS SOFTWARE, EVEN IF ADVISED OF THE POSSIBILITY OF SUCH DAMAGE.

▣ zlib

<http://www.zlib.net/>

zlib.h – interface of the 'zlib' general purpose compression library version 1.2.3, July 18th, 2005

Copyright (C) 1995-2004 Jean-loup Gailly and Mark Adler

This software is provided 'as-is', without any express or implied warranty. In no event will the authors be held liable for any damages arising from the use of this software.

Permission is granted to anyone to use this software for any purpose, including commercial applications, and to alter it and redistribute it freely, subject to the following restrictions:

1. The origin of this software must not be misrepresented; you must not claim that you wrote the original software. If you use this software in a product, an acknowledgment in the product documentation would be appreciated but is not required.
2. Altered source versions must be plainly marked as such, and must not be misrepresented as being the original software.
3. This notice may not be removed or altered from any source distribution.

Jean-loup Gailly jloup@gzip.org, Mark Adler madler@alumni.caltech.edu

cURL

<http://curl.haxx.se>

COPYRIGHT AND PERMISSION NOTICE

Copyright (c) 1996 - 2011, Daniel Stenberg, <daniel@haxx.se>.

All rights reserved.

Permission to use, copy, modify, and distribute this software for any purpose with or without fee is hereby granted, provided that the above copyright notice and this permission notice appear in all copies.

THE SOFTWARE IS PROVIDED "AS IS", WITHOUT WARRANTY OF ANY KIND, EXPRESS OR IMPLIED, INCLUDING BUT NOT LIMITED TO THE WARRANTIES OF MERCHANTABILITY, FITNESS FOR A PARTICULAR PURPOSE AND NONINFRINGEMENT OF THIRD PARTY RIGHTS. IN NO EVENT SHALL THE AUTHORS OR COPYRIGHT HOLDERS BE LIABLE FOR ANY CLAIM, DAMAGES OR OTHER LIABILITY, WHETHER IN AN ACTION OF CONTRACT, TORT OR OTHERWISE, ARISING FROM, OUT OF OR IN CONNECTION WITH THE SOFTWARE OR THE USE OR OTHER DEALINGS IN THE SOFTWARE.

Except as contained in this notice, the name of a copyright holder shall not be used in advertising or otherwise to promote the sale, use or other dealings in this Software without prior written authorization of the copyright holder.

c-ares

<http://c-ares.haxx.se>

Copyright 1998 by the Massachusetts Institute of Technology.

Permission to use, copy, modify, and distribute this software and its documentation for any purpose and without fee is hereby granted, provided that the above copyright notice appear in all copies and that both that copyright notice and this permission notice appear in supporting documentation, and that the name of M.I.T. not be used in advertising or publicity pertaining to distribution of the software without specific, written prior permission. M.I.T. makes no representations about the suitability of this software for any purpose. It is provided "as is" without express or implied warranty.

License Information for the Software Used in the Unit

About GPL (GNU-General Public License), LGPL (GNU Lesser General Public License) License

This product uses GPL/LGPL software and software made by other companies.

After you purchase this product, you may procure, modify or distribute the source code of the GPL/LGPL software that is used in the product.

DENON provides the source code based on the GPL and LGPL licenses at the actual cost upon your request to our customer service center. However, note that we make no guarantees concerning the source code. Please also understand that we do not offer support for the contents of the source code.

Dimensions

Unit : in. (mm)

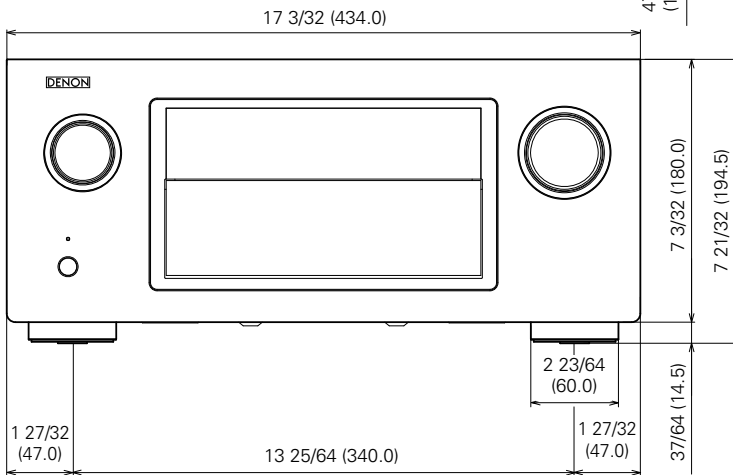
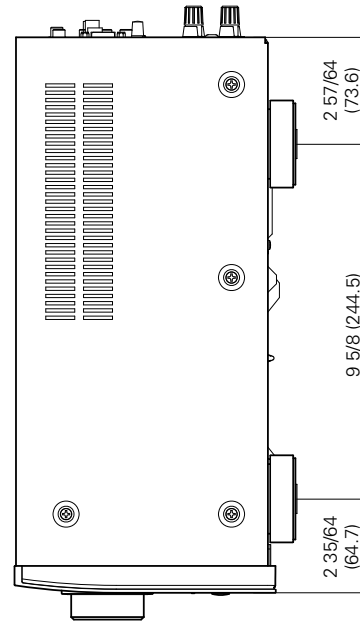
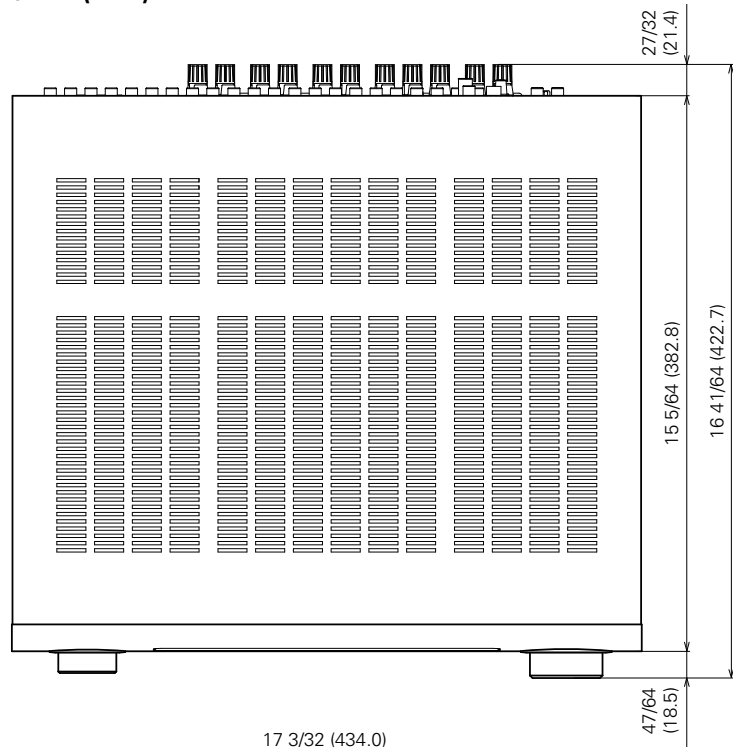

Weight : 36 lbs 6 oz (16.5 kg)

