

Instructions for Use



- Ultrasound Inhaler IHG 375
- Micro-fine atomisation of the inhalation solution by a special misting technology
- Application possible in various positions
- Portable device, in a handy size for inhaling medication during the day
- Noiseless operation
- Easily handled with a one-button function
- Device is easily cleaned
- Battery-operated with 2 x AA batteries
- Mains-operated, possible with a 230 V / 3 V DC adapter (not included)
- 24-month warranty
- Contents: 1 Inhaler IHG 375, 1 flexible mask for adults, 1 flexible mask for children, 1 mouthpiece, 1 connecting piece, 1 storage bag, 1 Instructions for Use, 2 x 1.5 V AA-batteries

No.	Subject	Page
1.0	What do the symbols mean?	4
2.0	Basic Information	4
2.1	What are the properties of the Inhaler IHG 375?	4
2.2	Information about the application of the Inhaler IHG 375	4
3.0	Safety Instructions	5
3.1	General Safety Instructions	5
3.3	For which usage / environment is the Inhaler IHG 375 suitable?	6
3.4	For which usage / environment is the Inhaler IHG 375 <u>not</u> suitable?	6
3.5	For which application area is the Inhaler IHG 375 suitable?	7
3.6	For which application area is the Inhaler IHG 375 <u>not</u> suitable?	7
3.7	Usage by children and youths	7
3.8	Advice on the application of the Inhaler IHG 375	8
4.0	Which medicines are suitable for inhalation?	8
4.1	Which medicines are <u>not</u> suitable for inhalation?	9
4.2	Storage / Maintenance of the Inhaler IHG 375	9
4.3	Hygiene measures	9
4.4	Operation with a Power Supply Unit 3 V / DC (optional)	10
5.0	Delivery Extent / Contents of Box	11
6.0	Disposing of the Inhaler IHG 375	12
7.0	Changing Batteries and Advice on Batteries	12
8.0	Designations / Functions of the Inhaler IHG 375	13
9.0	Starting to use the Inhaler IHG 375	14
10.0	Using the Mouthpiece	15
11.0	Using the Mask	15
12.0	Advice on how to use the Inhaler	16
13.0	Measures to be taken after having used the Inhaler	17

No.	Subject	Page
14.0	Cleaning and Disinfecting the Inhaler IHG 375 and the Accessories	18
14.1	Cleaning the Inhaler and its Accessories	18
14.2	Disinfecting the Inhaler and its Accessories	18
15.0	Technical Malfunctions, Rectifying Problems	19
16.0	Information regarding electromagnetic immunity	20
17.0	Technical Data, Symbols, Pictograms	24
18.0	Warranty	25

Dear Customer,
may we congratulate you for having purchased the Inhaler IHG 375 and express our thanks for your trust in our product. In order to guarantee your inhaler to function optimally and maintain its performance, we kindly ask you to read the instructions for use before using the inhaler for the first time. Thus it is ascertained that you will enjoy this product for a long time.



1.0 What do the symbols mean?

The safety symbols shown in these instructions for use give advice on the intended use of the inhaler and also to ensure your safety.

The symbols represent the following:



Read and follow the instructions for use!



Warning/Danger: Improper use may cause serious injuries, damage and be life threatening!



This advice should be followed implicitly!



Warning about the danger of infection: The infection can be caused by viruses, bacteria, fungi or the like!

2.0 Basic Information

2.1 What are the properties of the Inhaler IHG 375?

The Inhaler IHG 375 is an inhaling device for atomising liquid medicines and other medical remedies. By being atomised, medication and medical remedies approved for the inhalation therapy can be absorbed by the respiratory tract in form of aerosols.

2.2 Information about the application of the Inhaler IHG 375

The Inhaler IHG 375 is suited for the treatment of the respiratory tract illnesses, such as e.g. asthma or allergies by using liquid medication and other medical remedies. In the appliance's atomiser the liquid is transformed into an aerosol by a special ultrasound technology that - due to its properties - can easily be inhaled, distributed and absorbed into the upper and lower respiratory tract. In case there is not enough liquid available, the device switches off automatically. It can be operated either with two AA-batteries or with a 3 V power supply unit (optional). The device is suitable to be used at home. Inhaling liquid medicines and other medical remedies should only take place under medical instructions and in a quiet and relaxed situation. When using the device, breathe in slowly and deeply so that the aerosol can be distributed into the finest bronchial tubes, and subsequently breathe out normally.

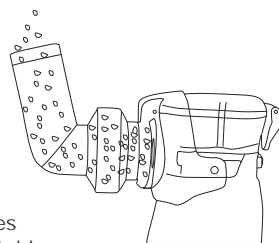

3.0 Safety Instructions



3.1 General Safety Instructions

- 3.1.1 In case of a malfunction the inhaler must not be used, dismantled, repaired by yourself or modified (changed). Damage can be caused by using the inhaler incorrectly.
- 3.1.2 Should irregularities become apparent at the inhaler, stop using the device at once and consult your doctor.
- 3.1.3 Should you have any questions or doubts about using the inhaler, ask your doctor prior to using the device. Using the inhaler does not replace a medical diagnosis and treatment!
- 3.1.4 It is imperative that you should ask your doctor about the type, dosing and application of liquid medicines and other medical remedies that are best suited for you to inhale with this device.
- 3.1.5 Keep these instructions for use in a safe place for the period of the product's life span and for future reference. Also pass these instructions on with the device, should you give it to a third person. Make the instructions for use available to third persons. The instructions for use are part of the inhaler.
- 3.1.6 In order to avoid damage and dangers, improper use and not using the device in accordance with the instructions for use must be avoided!
- 3.1.7 Only use the device together with the attached accessories or original spare parts. Never use accessories from different appliances.
- 3.1.8 Do not deposit heavy or sharp-edged objects on the inhaler or its accessories.
- 3.1.9 Always check the inhaler for malfunctions prior to using it. Should you find a fault resp. a defect, do not use the device.
- 3.2.0 Take care not to subject the inhaler to hard impacts or even drop it.
- 3.2.1 Clean and disinfect the inhaler after every application. Instructions for cleaning and disinfection can be found on Page 18.
- 3.2.2 Never leave the inhaler and power supply unit in reach of children or persons who need to be looked after!
- 3.2.3 Never clean the basic casing and the power supply unit under running water or other liquids and never immerse them into any liquids!
- 3.2.4 Take care that no liquid medication or other medical remedies run or drip onto or into the inhaler or the power unit.
- 3.2.5 Always observe the generally required hygiene measures when using the inhaler.
- 3.2.6 Be careful that the aerosol from the atomiser does not get into contact with your eyes. Depending on the medicine, it is possible that the aerosol may have a damaging effect on your eyes.

3.3 For which usage / environment is the Inhaler IHG 375 suitable?

- 3.3.1 Use the inhaler exclusively for the intended purpose: for inhaling suitable liquid medicines and other medical remedies via the respiratory tract of a person. Any other use is considered to be improper and may lead to damages or even compromise your health. The manufacturer is not liable for damages that have been caused by improper or incorrect use.
- 3.3.2 A treatment with the inhaler does not replace medical advice or treatment!
Always ask your doctor first in case you are in pain or have an illness.
- 3.3.3 This inhaler is a medical appliance. Only use liquid medicines and other medical remedies that are suitable for this device and only according to the instructions and prescriptions issued by your doctor. Always follow the application- and safety advice of the medicines or other remedies!
- 3.3.4 If not otherwise prescribed by the doctor, we recommend an average period of treatment of approximately 15 minutes up to three times daily.

3.4 For which usage / environment is the Inhaler IHG 375 not suitable?



- 3.4.1 The inhaler must not be used at the same time as other medical and electrical appliances of any kind.
- 3.4.2 Do not use the inhaler while having a shower, swimming, in the sauna or in other surroundings with a high air humidity. Keep away any kind of liquid during the application.
- 3.4.3 Do not use the inhaler in the vicinity of highly inflammable substances and gases or explosives.
- 3.4.4 The inhaler can influence other electric appliances negatively or be influenced by other electric appliances. Therefore do not use the inhaler in the vicinity of other electric appliances.
- 3.4.5 Do not use the inhaler at a distance of less than 1.5 m to a short-wave- or microwave appliance resp. a high frequency-HF-surgical appliance. Do not use the inhaler in the mountains above 2000 m.
- 3.4.6 The inhaler is designed for personal use, not, however, for being used commercially.
- 3.4.7 Remember that portable and mobile high-frequency communication devices (e.g. mobile phones) may influence electric medical appliances.
- 3.4.8 Electric medical devices are subject to special safety measures with regard the electromagnetic compatibility (EMC). Therefore, please observe the EMC-advice (Pages 20 - 23) when installing and using the device.

3.5 For which application area is the Inhaler IHG 375 suitable?

- 3.5.1 The device can be used for an inhaling therapy in case of an acute and chronic disease of the respiratory tract. Due to the finely sprayed aerosol, the active ingredients of the atomised liquid medicines or medical remedies are distributed very well in the respiratory tract and thus prevent illnesses to manifest themselves in the respiratory tract or to soothe or heal already existing complaints.
- 3.5.2 The portable, easily handled device operates noiselessly, and with its simple inhalation application is particularly suitable to be used at home.
- 3.5.3 As the device can be tilted up to an angle of approximately 45°, it can also be used in a lying down position, e.g. or for a child being held in one's arm.

3.6 For which application area is the Inhaler IHG 375 not suitable?



- 3.6.1 Essential medicinal plant oils, gargle solutions, liquids and solutions for rubbing in, or for steam baths must not be used in connection with the Inhaler IHG 375; these are too viscous and cannot be atomised. They may also damage the device.
- 3.6.2 In case of a hyper-sensitivity of the respiratory tract, liquid medicines and medicinal remedies containing essential oils may cause a spasmodic constriction of the bronchi with breathing problems (bronchospasm). Ask your doctor!

3.7 Usage by children and youths

- 3.7.1 Children and youths under the age of 18 should always be supervised when using the inhaler.
- 3.7.2 Keep the inhaler out of reach of children and youths below 18.
- 3.7.3 Do not let children handle the inhaler. The small parts could be swallowed by children and lead to suffocation. Children may also injure themselves while handling the device.

3.8 Advice on the application of the Inhaler IHG 375

- 3.8.1 Before using the device take care that the components and accessories (e.g. mouthpiece and mask) have been assembled in accordance with these instructions for use (see Page 14 -15).
- 3.8.2 Avoid shaking the inhaler while in use. This could lead to a malfunction and the liquid could leak out.
- 3.8.3 Always switch the inhaler off when installing and de-installing accessories, or filling the medication container.
- 3.8.4 In case the application with the inhaler is not successful, consult your doctor in any case.
- 3.8.5 Due to hygiene reasons, each user should only use his own accessories (e.g. mouthpiece and inhaling mask).
- 3.8.6 Only use the inhaler with liquid medication and medicinal remedies! Never use other liquids of any kind for the device as this could damage your health and / or also damage the device!
- 3.8.7 Do not cover the air inlets of the device as this may prevent the air from circulating.
- 3.8.8 Do not connect the power supply unit (optional) of the inhaler to the 230 V power supply with wet or damp hands!
- 3.8.9 Before connecting the power supply unit, ascertain that the mains voltage V (Volt) and the frequency in Hz (Hertz) of the adapter complies with that of the power supply.
- 3.9.0 When using the device with the power supply unit, always disconnect the power supply unit from the power supply and the inhaler upon finishing the application!
- 3.9.1 Take care that the device is disconnected from the power supply before being cleaned.
- 3.9.2 Do not use the inhaler in an ambient temperature of above 40 °Celsius! There are further details about the permissible ambient conditions in Chapter 17.0 on Page 24.
- 3.9.3 Do not carry out any other activity while using the inhaler. Make sure that you use the inhaler in a calm and relaxed atmosphere.

4.0 Which medicines are suitable for inhalation?

- 4.0.1 The inhaler is suitable for liquid medicines or medicinal remedies that are used for preventing and treating acute and chronic illnesses of the upper and lower respiratory tract. The medicine is atomised in the device. The thus produced fine aerosol, the active ingredients of the liquid medicines or medicinal remedies are easily distributed in the respiratory tract and in that way act preventative or, in case of already existing illnesses will soothe or support the healing process of the disease.
- 4.0.2 This inhaler is a medical appliance. Only use liquid medicines and other medical remedies that are suitable for this device and only according to the instructions and prescriptions issued by your doctor and always follow the application- and safety advice of the medicines or other remedies!

4.1 Which medicines are not suitable for inhalation?

- 4.1.1 Essential medicinal plant oils, gargle solutions, liquids and solutions for rubbing in, or for steam baths must not be used in connection with the Inhaler IHG 37; these are too viscous and cannot be atomised. They may also damage the device.
- 4.1.2 In case of a hyper-sensitivity of the respiratory tract, liquid medicines and medicinal remedies containing essential oils may cause a spasmodic constriction of the bronchi with breathing problems (bronchospasm). Ask your doctor!
- 4.1.3 Never use liquid medicines and medicinal remedies in your inhaler without consulting your doctor beforehand and getting advice from him!
- 4.1.4 Never inhale aerosols consisting of a mixture of different medicines – unless this has explicitly been discussed with your doctor and he has prescribed this.

4.2 Storage / Maintenance of the Inhaler IHG 375

- 4.2.1 The Inhaler IHG 375 is maintenance-free.
- 4.2.2 Do not dismantle or repair the device as this could cause technical accidents or it may also cause injuries. **Warning!** Danger of injuries!
- 4.2.3 Remove the batteries from the device, if it is not used for a longer period of time.
- 4.2.4 In case the inhaler IHG 375 is used commercially a safety-technical inspection becomes necessary in compliance with § 6 MPBetreibV (Medical Devices Operator Ordinance) every 24 months. The safety-technical inspections must be carried out by a specialist company for medical products. Further information can be obtained from our Service Center (see Page 25).
- 4.2.5 Store the device as well as its accessories in a dry, clean and safe place.
- 4.2.6 Protect the device from direct sunlight, impacts, heat, open fire as well as any contact with corrosive liquids! Never place the device on a hot surface!
- 4.2.7 Never try to dry the device or its components in a microwave oven!
- 4.2.8 Always use and store the device in relevant ambient conditions (temperature and air humidity) in accordance with our instructions on Page 24.

4.3 Hygiene Measures



WARNING: Danger of infection through viruses, bacteria and germs! Infections can transmit life-threatening diseases! The device must be cleaned and disinfected after every application. By adhering to these measures the risk of infection can be minimised.

- 4.3.1 The device and also the accessories must be thoroughly cleaned and disinfected before their initial use, after a longer period of storage as well as after every application!
- 4.3.2 Also follow the advice of Chapter 14 on Page 18 regarding cleaning and disinfecting the device and its accessories.

- 4.3.3 The inhaler should not be switched on during cleaning and servicing.
- 4.3.4 Clean the surfaces of the inhaler gently with a soft, slightly damp cloth; take care that no water can penetrate the device. In case of a heavier soiling you can use a mild detergent. The inhaler must, however, not be switched on during the cleaning process. To this end remove the batteries from the device prior to each cleaning process. Subsequently leave the inhaler to dry out thoroughly. Do not use any chemical cleaning agents or abrasive products to clean the inhaler.
- 4.3.5 Due to hygiene reasons and in order to avoid passing on any infection, each user should use his own accessories. This applies to the atomising unit, atomiser cover, connecting piece, mouthpieces and above all the masks, which cannot be disinfected by being boiled!
Mouthpiece, connecting piece and atomiser cover can be disinfected by being boiled. Place the parts in a steriliser or in a saucepan with boiling water, immerse the parts completely into water and boil them for about 20 minutes. Disinfecting by boiling must not be used for the atomiser unit, atomiser head with metal mesh, basic unit and masks. A usual suitable disinfectant can be used for disinfecting these parts, if necessary. Subsequently, leave the parts and the device to dry out thoroughly.
- 4.3.6 Never immerse the inhaler into water or other liquids.
- 4.3.7 Empty the medication container after every application, and make sure that there is no residual liquid left in the device!

4.4 Operation with a Power Supply Unit 3 V / DC (optional)



The Inhaler IHG 375 can also be operated with a suitable AC/DC power supply unit with a voltage of 3 Volt and 1.0 A (Ampere). Before connecting the power unit to the 230 V mains, make sure that the voltage V (Volt) and the frequency Hz (Hertz) match.



Attention!

While being connected to the power supply unit, there must not be any batteries in the device! Also, rechargeable batteries must not be charged in the device while the inhaler is connected to the power supply unit! There is an immediate danger of being injured through an explosion and also damage caused to objects!

Remove the batteries first, before connecting the device to the power supply unit.
Remove the power supply unit from the device and the 230 V mains after every application.

5.0 Delivery Extent / Contents of Box

Please check that all parts have been delivered upon unpacking the parts and also check for damages. Do not use the device in case of any apparent damage, or if the instructions for use are missing!

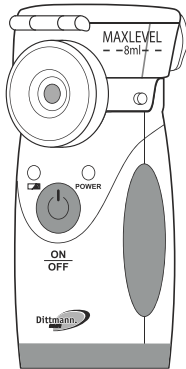

1 x Inhaler IHG 375



1 x Instructions for Use

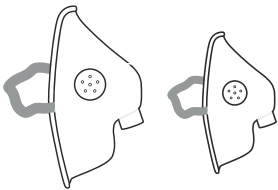

1 x Mask for Adults
1 x Mask for Children

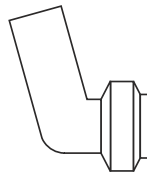

1 x Connecting Piece

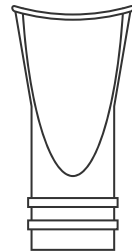

1 x Mouthpiece



2 x 1,5 V AA Batteries

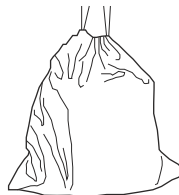

1 x Storage Bag

6.0 Disposing of the Inhaler IHG 375

- 6.1 In case the Inhaler IHG 375 is to be recycled, the disposal must follow the legal regulations. To this end ask your municipal offices or a waste disposal specialist company. Dispose of the inhaler in compliance with the EU-Guideline 2002/96/EG-WEEE on old electric- and electronic appliances.



7.0 Changing Batteries and Advice on Batteries

- 7.1 Insert the 2 x 1.5 V AA batteries into the device by observing the correct polarities (+ and - Pole).
- 7.2 Types of batteries: For the Inhaler IHG 375 you require 2 AA batteries. Do not use rechargeable batteries!

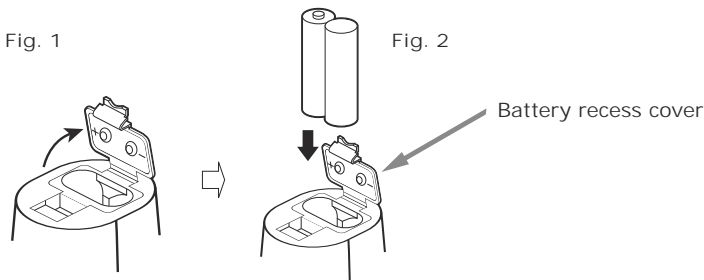

For opening the cover press the locking clip towards the batteries and open the battery recess according to Fig. 1. Remove the empty batteries and replace them with two new 1.5 V AA batteries (Fig. 2). Observe the correct polarity when inserting the batteries (see marking / indentation +/- on the interior surface of the battery recess cover). Close the cover and press it down, until it engages firmly.

- 7.3 Disposing of batteries: Empty batteries do not belong into the household waste. Dispose of them through your electric appliances trader or take them to the public recycling collection point. You, as a consumer, are legally obliged to return empty batteries.
- 7.4 These signs indicate hazardous batteries:
Pb = contain lead, Hg = contain mercury, Cd = contain cadmium.
- 7.5 If swallowed, batteries may be life threatening. Therefore, keep batteries and products out of reach of children. In case a battery was swallowed, it is imperative that a doctor is consulted at once.
- 7.6 In case a battery has leaked, avoid contact with skin, eyes and mucous membranes. Rinse the affected areas with lots of clear water and consult a doctor immediately or seek medical help.
- 7.7 Batteries must not be recharged (apart from re-chargeable batteries), be dismantled, put into an open fire or short-circuited.
- 7.8 Protect the batteries from excessive heat. Remove the batteries from the product, once they are empty or you do not use the product for a longer period of time. Thus you avoid damage that may occur by leaking.



8.0 Designations / Functions of the Inhaler IHG 375

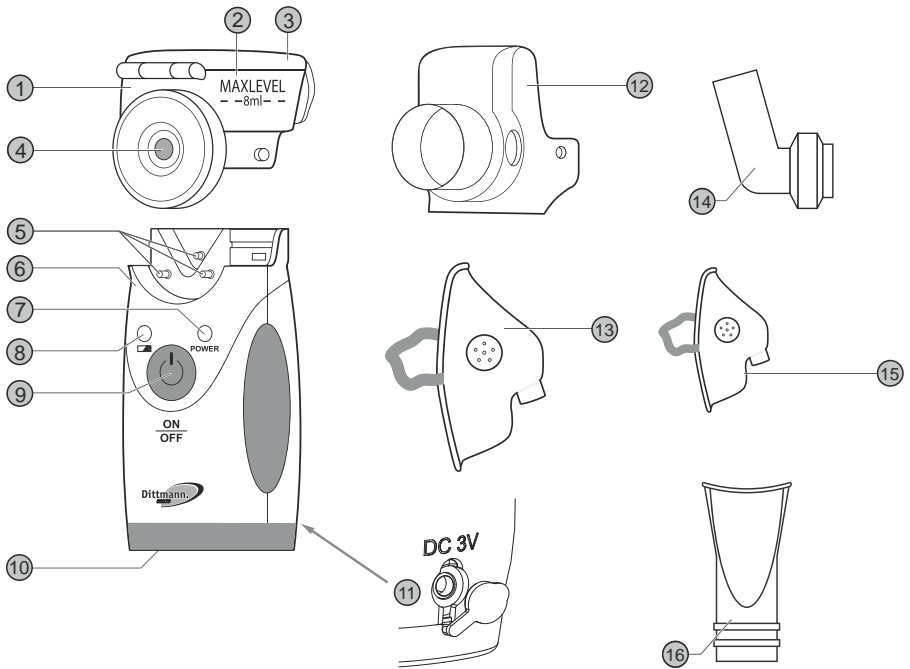

1. Atomiser Unit
2. Medication Container
3. Container Cover with Locking
4. Atomiser Head with Metal Mesh
5. Contacts/Electrodes for the Atomiser Unit
6. Basic Unit/Basic Casing of the Inhaler
7. LED (green) indicating the operational readiness
8. LED (yellow) indicating weak batteries
9. ON/OFF Switch
10. Battery Recess Cover
11. Connection bush for Power Supply Unit 3 V DC with Cover (on the back of the device)
12. Atomiser Cover
13. Mask for Adults
14. Connecting Piece
15. Mask for Children
16. Mouthpiece

9.0 Starting to use the Inhaler IHG 375

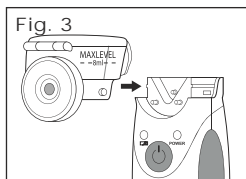

Step 1

Take the basic unit (6) in one hand and the atomiser unit (1) in the other hand and slide the atomiser unit (1) onto the basic unit (6) in the direction of the arrow, according to Fig. 3. A sound signal (Ka) will indicate that the atomiser unit is properly installed on the basic unit. Attention! The inhaler must not be switched on!

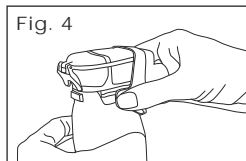

Step 2

Take the basic unit (6) into your left hand and slide the bottom part of the atomiser cover (12) onto the basic unit in the direction of the arrow, according to Fig. 4. A sound signal (Ka) will indicate that the atomiser cover (12) is properly installed on the atomiser unit (1).

Attention! The inhaler must not be switched on! Store the thus assembled device in the dry and clean storage bag. For the start-up: Continue with Step 3!

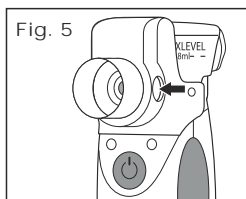

Step 3

Remove the atomiser cover (12) according to Fig. 5 in reverse order to Step 2.

Step 4

Now hold the basic unit (6) in the left hand and open the atomiser unit (1) by loosening the locking at the container cover of the atomiser (3) with the thumb and index finger of your right hand and by lifting the cover of the medication container (2) towards the top (see Fig. 6).

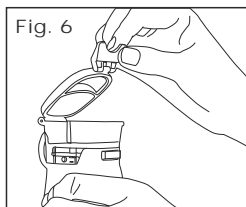

Step 5

Pour the liquid medication into the container for liquids next to the atomiser head (4) (see Fig. 7); a minimum of 0.5 ml and a maximum of 8 ml can be added. In order to increase or reduce the temperature of the added liquid, hot or cold water can be filled into the chamber next to the container for the liquid medicines.



Step 6

Close the cover of the medication container (3) according to Fig. 8 and press the locking at the container cover of the atomiser unit (1) towards bottom with the thumb of your right hand, until a sound signal (Ka) indicates that the cover of the medication container (3) is properly locked.

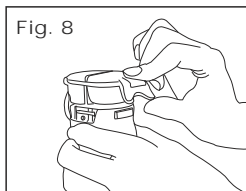

Step 7

Replace the atomiser cover (12) on the device (see Step 2). The device is now ready for operation.

10.0 Using the Mouthpiece

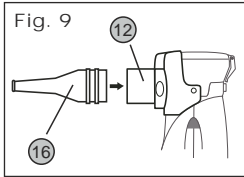

The mouthpiece (16) included in the delivery extent is used for inhaling atomised liquid medicines (aerosols) through the mouth resp. the mouth and pharynx.

Step 1

Install the mouthpiece (16) by placing it in the direction of the arrow on the connecting piece of the atomiser cover (12), as shown in Fig. 9.

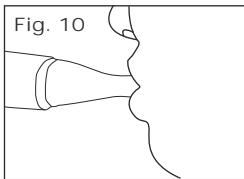

Step 2

Now insert the mouthpiece into your mouth and hold it with your lips. Press the ON/OFF switch (9).

The green LED (7) lights up and the device starts operating. Inhale the atomised liquid medication (see Fig. 10) by slowly breathing in deeply through the mouth so that the aerosol can be distributed in the mouth and pharynx right down to the finest bronchial tubes. Breathe out normally through your nose. Press the ON/OFF switch (9) again to switch off the device. The green LED (7) goes out.

11.0 Using the Mask

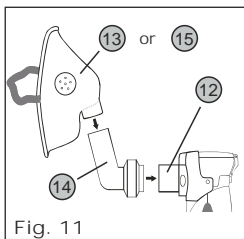

The mask for adults (13) and the mask for the children (15) are used for inhaling atomised liquid medication (aerosols) through the nose resp. the nose and pharynx.

Step 1

Install one of the masks (13) (for adults) or (15) (for children), by placing the connecting piece (14) in the direction of the arrow onto the connection piece of the atomiser cover (12) as shown in Fig. 11, and subsequently push the connection piece of the mask into the connecting piece (14) in the direction of the arrow.

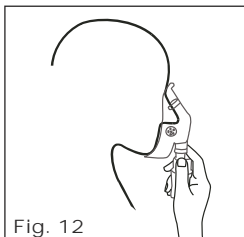

Step 2

Now adjust the mask such that it rests lightly over the patient's nose and mouth. Pull the elastic band of the mask over the head so that the mask is positioned safely (see Fig. 12). Press the ON/OFF switch (9). The green LED (7) lights up and the device starts operating. Inhale the atomised liquid medicine by slowly and deeply breathing in through the nose, enabling the aerosol to be distributed in the nose and pharynx and the respiratory tract. Breathe out normally through the mouth. Press the ON/OFF switch (9) again to switch off the device. The green LED (7) will go out.

ADVICE: If required, it is possible to switch from the mouthpiece to the mask during the application.

12.0 Advice on how to use the Inhaler

Exchange defective or worn parts (e.g. masks, mouthpieces, connecting pieces) only for original parts.

Use the mouthpiece such that the inhaled aerosol is not sprayed onto the tongue.

Do not swallow the inhaled aerosol and take care that the aerosol reaches the places in the respiratory tract that are the cause of the complaints.

In order to guarantee the best possible effect, it is recommended to carry out an inhalation application in a quiet and relaxed atmosphere and with comfortable clothes, by breathing in slowly and deeply, if possible, so that the aerosol can reach the remote parts of the respiratory tract. Should you wish to use the inhaler in bed, you should place a pillow under your back to support the spine and keep it straight. An uncomfortable body posture and irregular breathing may make inhaling more difficult and block the respiratory tract.

Take care that the device is tilted at the most by an angle of 45° during application. If the device is tilted further it is possible that the liquid medication leaks out of the atomiser head ④.

If the device is tilted such that the atomiser head ④ has no contact to the liquid medication any more, the device switches off automatically after approx. 10 seconds.

If there is only little liquid medication or medicinal remedy left in the container ②, you can tilt the device towards you (by max. 45°) to make use of the remaining liquid. Do not shake the device during application as this may lead to a malfunction resp. an automatic switching off or even to the liquid leaking out.

Press the ON/OFF switch ⑨, should you wish to stop or interrupt the treatment. As soon as the liquid medication or the medicinal remedy in the medication container ② is used up, the device switches off automatically.

WARNING OF LOW BATTERIES: As soon as the batteries of the device are becoming weak, the yellow LED ⑧ lights up as a warning. Keep fresh batteries in stock to be able to exchange them in case they are required. When you switch on the device with the ON/OFF switch ⑨, the green LED ⑦, however, does not light up, it is possible that the batteries are completely flat. Exchange them for new batteries in this case (see Chapter 7.0 on Page 12).

13.0 Measures to be taken after having used the inhaler

Always switch the device off with the ON/OFF switch **9** after an application. When using the device with the power supply unit (optional), always remove this from the device and from the 230 V power supply after application.

Remove the mouthpiece **16** resp. the mask **13** (for adults) or **15** (for children) and the connecting piece **14** from the device in reverse order as described on Page 15 (Chapter 10.0, Step 2 and 11.0, Step 2) after each application. Then remove the atomiser cover **12** from the device.

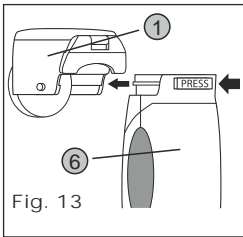

Fig. 13

Now remove the atomiser unit **1** from the device. To this end hold the basic unit **6** in your left hand and press the button PRESS with your left thumb towards the arrow (see Fig. 13). Then take hold of the atomiser unit **1** with your right hand at both sides of the lower end and carefully pull this away from the basic unit **6**.

Now empty the residual medication or medicinal remedy liquid from the medication container **2** and subsequently clean the device according to the instructions on Page 18. In order to clean the atomiser head **4** it is recommended to hold the part under clean water for about 1 - 2 minutes after each application. Take care that the atomiser unit **1** and the contacts for the atomiser unit **5** are always kept clean!

ATTENTION: Never touch the metal mesh of the atomiser head with your hands, or pointed or hard objects! this may damage the metal mesh!

ADVICE: The atomiser unit **1** has a life span of approx. 6 months (in case of 3 applications per day). You can purchase spare parts from your specialist trader.

14.0 Cleaning and Disinfecting the Inhaler IHG 375 and the Accessories



WARNING: Danger of infection through viruses, bacteria and germs! Infections can transmit life-threatening diseases! The device must be cleaned and disinfected after every application. By adhering to these measures the risk of infection can be minimised.

14.1 Cleaning the Inhaler and its Accessories

Always remove all accessories after each application (including atomiser unit ①, atomiser cover ⑫, mouthpiece ⑮ and mask ⑬/⑰ with connecting piece ⑭) from the device.

Open the container cover ③ of the atomiser unit and drain the residual liquid medication or medicinal remedies from the container ②. In order to clean the atomiser head ④, it is recommended to rinse the device about 1 - 2 minutes under clear water after each application.

Subsequently carefully clean the accessories (atomiser unit ①, atomiser cover ⑫, mouthpiece ⑮, mask ⑬/⑰ and connecting piece ⑭). The basic unit ⑥ should not be rinsed but only wiped with a damp and then with a dry gauze. Dry the accessories immediately after cleaning with medicinal gauze. It is important that the metal mesh in the atomiser head ④ is only touched very carefully and not with your bare hands, sharp or hard implements. Dry the water inlet and water outlet of the atomiser head ④ carefully with cotton swabs. Store the device and its accessories in a clean bag after cleaning.

14.2 Disinfecting the Inhaler and its Accessories

Rinse the atomiser cover ⑫, mouthpiece ⑮, mask ⑬/⑰, and connecting piece ⑭ approx. 10 minutes in a 0.1% ammonium chloride solution. Subsequently rinse the parts under clean water and dry them with medicinal gauze. Clean the metal mesh of the atomiser head ④ carefully with a medicinal swab soaked in medical alcohol. Then rinse the atomiser head ④ with clear water and dry the surface carefully with medicinal swabs (just dab!).

The mouthpiece ⑮, connecting piece ⑭, and the atomiser cover ⑫ can be disinfected by boiling. Place these parts in a steriliser or a saucepan with boiling water such that all parts are completely submerged and boil for approx. 20 minutes. Dry the accessories with medicinal gauze. Disinfection by boiling must not be used for the atomiser unit ①, atomiser head with metal mesh ④, basic unit ⑥, masks ⑬/⑰, adapter, and storage bag.

15.0 Technical Malfunctions, Rectifying Problems

Malfunction	Cause	Solution
The device only generates very little atomised spray.	The yellow LED display 8 for low batteries lights up.	Replace the batteries with new ones. Observe the correct polarity!
	The atomiser unit is contaminated.	Clean the atomiser unit according to the instructions of Page 18.
The green LED 7 does not light up. The device does not function.	The batteries have been inserted with the wrong polarities.	Check, whether the batteries have been inserted with the correct polarities into the battery recess.
	The battery voltage is too low.	Replace the batteries with new ones. Observe the correct polarity!
	The power unit (optional) has not been connected properly to the bush (3 V) 11 of the inhaler and / or the power plug (230 V) has not been connected properly.	Connect the power unit correctly to the 3 V bush at the device and / or to the 230 V power supply.
	The atomiser unit is not installed properly.	Install the atomiser unit properly in accordance with the instructions of Page 14.
The green LED 7 lights up but the device does not work.	The atomiser unit is not installed properly.	Install the atomiser unit properly in accordance with the instructions of Page 14.
	The atomiser is heavily contaminated.	Clean the atomiser unit according to the instructions of Page 18.
	The liquid medication does not come into contact with the atomiser head 4 .	Tilt the device slightly towards you, enabling the liquid to collect at the atomiser head 4 .
	Bubbles are forming between the liquid medication and the atomiser head.	Gently shake the liquid medication in the container of the inhaler.
	The contact poles 5 at the casing are soiled.	Clean the contacts 5 with a dry cloth.

16.0 Information regarding electromagnetic immunity

Table 1 – Instruction and manufacturer's specifications – electromagnetic emissions – for all INSTALLATIONS and SYSTEMS (see 6.8.3.201 a) 3).

Instruction and manufacturer's specifications – electromagnetic emissions		
The (INSTALLATION or the SYSTEM) is designed for the use in the electromagnetic environment described below. The customer or the user of the (INSTALLATION or the SYSTEM) should ensure that it is used in such an environment.		
Emission test	Compliance	Electromagnetic environment – instruction
HF emissions CISPR 11	Group 2	The (INSTALLATION or the SYSTEM) only uses HF energy for its internal operation. Therefore, only very low HF emissions occur, which most probably do not cause any malfunctions in nearby electronic installations.

Guidelines and manufacturer's declaration – electromagnetic emissions		
The model IHG 375 is intended for use in an environment as specified below. The customer or the user of the model IHG 375 should ensure that it is used in such an environment.		
Electromagnetic interference measurements	Compliance	Electromagnetic environment – guideline
HF emissions according to CISPR 11	Group 2	The model IHG 375 is intended for use in all facilities, including residential environments and such environments that are directly connected to the public power supply, which also supplies buildings that are used for residential purposes.
HF emissions according to CISPR 11	Class B	
Harmonic current emissions according to IEC 61000-3-2	Not applicable	
Emission of voltage fluctuations/flicker according to IEC 61000-3-3	Not applicable	

16.0 Information regarding electromagnetic immunity

Guidelines and manufacturer's declaration – electromagnetic immunity			
The model IHG 375 is intended for operation in an electromagnetic environment as specified below. The customer or the user of the model IHG 375 should ensure that it is used in such an environment.			
Immunity tests	IEC 60601 – test level	Conformity level	Electromagnetic environment – guidelines
Electrostatic discharge immunity test according to IEC 61000-4-2	± 6 kV contact discharge ± 8 kV air discharge	Not applicable ± 8 kV air discharge	Floors should be made of wood or concrete or furnished with ceramic tiles. If the floor is furnished with synthetic material, the relative air humidity must be at least 30%.
Electrical fast transient/burst immunity according to IEC 61000-4-4	± 2 kV for power cables ± 1 kV for input and output cables	Not applicable	The quality of the supply voltage should correspond to the voltage of a typical commercial or hospital environment.
Surges according to IEC 61000-4-5	± 1 kV differential mode voltage ± 2 kV common mode voltage	Not applicable	The quality of the supply voltage should correspond to the voltage of a typical commercial or hospital environment.
Voltage dips, short interruptions and voltage variations according to IEC 61000-4-11	< 5% U_T (>95 % dip of U_T) during ½ period 40% U_T (60% dip of U_T) during 5 periods 70% U_T (30% dip of U_T) during 25 periods < 5% U_T (> 95% dip of U_T) during 5 s	Not applicable	The quality of the supply voltage should correspond to the voltage of a typical commercial or hospital environment. If the user of the model IHG 375 requires a continuous function also when interruptions in the energy supply occur, it is recommended to supply the model IHG 375 from an uninterruptible power source or a battery.
Magnetic fields at the power frequency (50/60 Hz) according to IEC 61000-4-8	3 A/m	3 A/m	Magnetic fields at the power frequency should correspond to typical values that can be found in a commercial or hospital environment.
NOTE U_T is the alternating mains voltage prior to application of test levels.			

16.0 Information regarding electromagnetic immunity

Guidelines and manufacturer's declaration – electromagnetic immunity			
The model IHG 375 is intended for operation in an electromagnetic environment as specified below. The customer or the user of the model should ensure that it is used in such an environment.			
Immunity tests	IEC 60601 – test level	Conformity level	Electromagnetic environment – guidelines
			Portable and mobile radio devices should not be used in closer proximity to the [device or system] including the cables as the recommended protective distance calculated in accordance with the formula for the respective transmission frequency. Recommended protective distance:
Conducted HF disturbances according to IEC 61000-4-6	3 Vrms 150 kHz to 80 MHz	3 Vrms	$d = 1.2\sqrt{P}$
Radiated HF disturbances according to IEC 61000-4-3	3 V/m 80 MHz to 2.5 GHz	3 V/m	$d = 1.2\sqrt{P}$ 80 MHz to 800 MHz
			$d = 2.3\sqrt{P}$ 800 MHz to 2.5 GHz
			Where P is the rated power of the transmitter in watt (W) according to the specification of the transmitter manufacturer and d is the recommended protective distance in metres (m). According to an on-site ^a investigation, the field strength of stationary radio transmitters is in all frequencies lower than the conformity level. ^b Disturbances are possible in the vicinity of devices carrying the following symbol.
			
NOTE 1 For 80 MHz and 800 MHz, the higher value is applicable.			
NOTE 2 These guidelines might not apply to all situations. The spreading of electromagnetic waves is influenced by absorptions and reflections of buildings, objects and people.			



16.0 Information regarding electromagnetic immunity

a. Theoretically, the field strength of stationary transmitters, such as base stations of wireless telephones and land mobile services, amateur radio stations, AM and FM radio and television stations, cannot be predicted precisely. An investigation of the site is recommended to determine the electromagnetic environment due to stationary HF transmitters. If the determined on-site field strength of the model IHG 375 exceeds the conformity level specified above, the normal operation of the model IHG 375 must be observed at every application site. If unusual performance characteristics are observed, additional measures might have to be taken, such as reorientation or relocation of the model IHG 375. b. Not applicable above the frequency range from 150 kHz to 80 Mhz.

Recommended protective distances between portable and mobile HF telecommunication devices and the [DEVICE or the SYSTEM].

The model IHG 375 is intended for operation in an electromagnetic environment in which the HF disturbances are controlled. The customer or user of the model IHG 375 may contribute to the avoidance of electromagnetic disturbances by observing the minimum distance between portable and mobile HF telecommunication devices (transmitters) and the model IHG 375, depending on the output rating of the communication device as specified below.

Rated power of the transmitter W	Protective distance depends on the transmission frequency m		
	150 kHz to 80 Mhz $d=1.2 \sqrt{P}$	80 Mhz to 800 Mhz $d=1.2 \sqrt{P}$	800 Mhz to 2.5 GHz $d=2.3 \sqrt{P}$
0.01	0.12	0.12	0.23
0.1	0.38	0.38	0.73
1	1.2	1.2	2.3
10	3.8	3.8	7.3
100	12	12	23

For transmitters whose rated power is not specified in the table above, the distance can be calculated with the help of the formula of the respective column, with P being the rated power of the transmitter in watt (W) in accordance with the specification of the transmitter manufacturer.

NOTE 1 For the calculation of the recommended protective distance of transmitters in the frequency range from 80 MHz to 2.5 GHz, an additional factor of 10/3 was used to minimise the possibility that a mobile/portable communication device unintentionally brought into the patient area could lead to disturbances.

NOTE 2 These guidelines might not apply to all situations. The spreading of electromagnetic waves is influenced by absorptions and reflections of buildings, objects and people.

17.0 Technical Data, Symbols, Pictograms

Model/Type:

Dimensions (LxWxH):

Weight:

Material:

LOT

SN

2013-04

CE 0123



Device Type Label:

Inhaler IHG 375

approx. 120 x 80 x 50 mm

approx. 130 g (without battery and accessories)

Plastic, Metals

Batch Description: **LOT** V1513IHG375

Serial No. **SN** 00001 (consecutive number)

Date of Manufacture: 2013-04 (year, month)

The Inhaler IHG 375 has been certified in compliance with EU-Guideline 93/42 EWG for medical products.

Manufacturer: Handelshaus Dittmann GmbH, Kissinger Straße 68, D-97727 Fuchstadt/Germany

Protection against electric shock acc. to Type BF (Body Float). An application device of the Type BF with a higher protection against an electric shock to the body, however, not directly to the heart.



Electric Data:

Power Supply:

3.0 V DC, 2 x 1.5 V AA or separate power unit 3 V DC / 1 A
 (V = Volt, DC = Direct Current, A = Ampere)

2 W (Watt)

Nominal Power (W):

Ultrasound Frequency (Hz): approx. 140 kHz (Kilohertz = 1000 oscillations per second)

Security Rating:

Type B, Class II

Atomiser Performance:

> approx. 0.25 ml/min (ml = millilitre, min = minute)

Capacity:

at least 0.5 ml / at a maximum 8 ml (ml = millilitre)

MMAD:

approx. 5 µm (µm = micrometer)

Operating Time:

approx. 90 minutes with two new AA alkaline batteries

Battery Warning:

with 2.2 V +/- 0.2 V (V = Volt)

Life Span Atomiser:

approx. 180 operating hours

Automatic Switch Off:

in case of lack of liquid

Application Data:

Ambient Temperature:

10 °C - 40 °C (degree Celsius)

Max. Air Humidity at

Normal Operation:

30% - 85% (per cent)

Details on Heights:

Application up to a height of a maximum of 2000 m

Storage- and Transport Data:

40°C

-10°C

85%

30%

Atmospheric Pressure:

Storage- and Transport Temperature:

-10 °C - 40 °C (degree Celsius)

Maximum air humidity during storage and transport:

30% - 85% (per cent)

700hPa - 1060hPa (hectopascal)

18.0 Warranty

The Inhaler IHG 375 purchased by you was developed and manufactured with the utmost care.

The legal warranty period is 24 months from the date of purchase for material- and manufacturing errors of the product. Please keep the receipt as evidence of having purchased the Inhaler IHG 375, in case of any warranty claims.

Excluded from the warranty is:

- Damage caused by improper use
- Deficiencies that were known to the customer upon the purchase
- Wear and tear parts
- Damage caused by unauthorised interference and due to customer's personal negligence

After the expiry of the warranty period you can send a defective device to the below mentioned address. Repairs to be carried out after the warranty has expired are chargeable.

In case of technical problems, questions and warranty claims regarding this device, you can contact us as follows:

ADVICE: In case of a complaint about the device, please contact the Service-Center initially.
If necessary, the Service-Center will organise the device to be returned.
Parcels sent to the Service-Center freight collect, will not be accepted!

Handelshaus Dittmann GmbH
Service-Center
Kissinger Straße 68
D-97727 Fuchsstadt / Germany
e-mail: hotline@servicecenter.tv
Telephone hotline: +49 (0) 180-6000228 (€ 0.20 per call from a German landline number, max. € 0.60 per call from a German mobile phone networks)
www.dittmann-gmbh.com

With Best Regards



Manufacturer: Handelshaus Dittmann GmbH
Kissinger Straße 68
D-97727 Fuchsstadt/Germany

