

**PHILIPS**

hue personal  
wireless  
lighting

Surimu

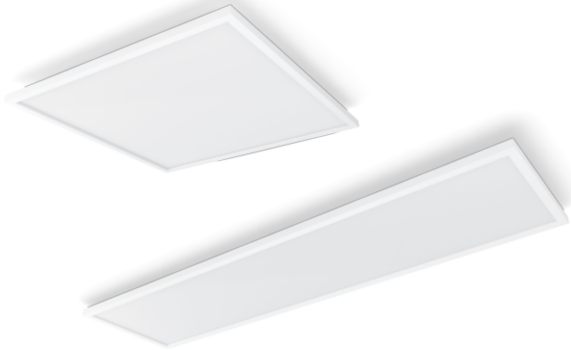

User manual  
Benutzerhandbuch  
Notice d'emploi  
Manual de usuario  
Manual do usuário  
Manuale d'uso

Incl.

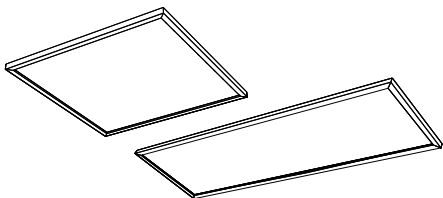

Excl.

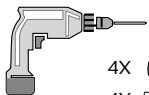

4X

4X

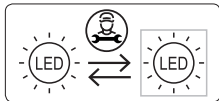
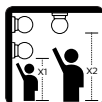
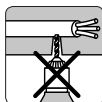
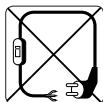
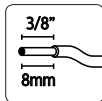
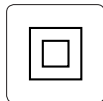
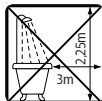
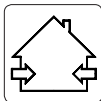
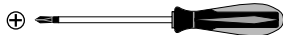

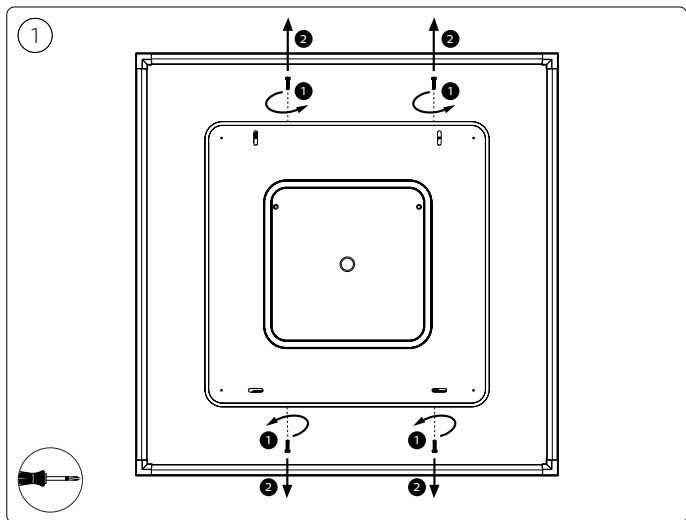
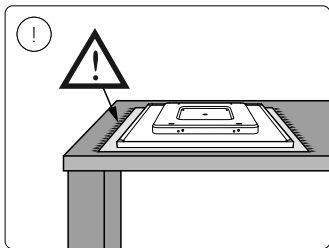
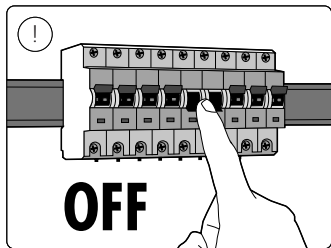

# Obsah je uzamčen

**Dokončete, prosím, proces objednávky.**

**Následně budete mít přístup k celému dokumentu.**



**Proč je dokument uzamčen? Nahněvat Vás rozhodně nechceme. Jsou k tomu dva hlavní důvody:**

- 1) Vytvořit a udržovat obsáhlou databázi návodů stojí nejen spoustu úsilí a času, ale i finanční prostředky. Dělali byste to Vy zadarmo? Ne\*. Zakoupením této služby obdržíte úplný návod a podpoříte provoz a rozvoj našich stránek. Třeba se Vám to bude ještě někdy hodit.

*\*) Možná zpočátku ano. Ale vězte, že dotovat to dlouhodobě nelze. A rozhodně na tom nezbohatneme.*

- 2) Pak jsou tady „roboti“, kteří se přiživují na naší práci a „vysávají“ výsledky našeho úsilí pro svůj prospěch. Tímto krokem se jim to snažíme překazit.

A pokud nemáte zájem, respektujeme to. Urgujte svého prodejce. A když neuspějete, rádi Vás uvidíme!