

TY-ASC51

Toshiba Portable Sound System Operation Manual

Thank you for purchasing this Portable Sound System.

To use this product safely, read and understand this operation manual thoroughly before using. After reading this manual, keep it in a safe place so that it can be referred to when necessary.



Safety precautions

5029300

The information you need to prevent danger to the user and other people as well as property damage is described below. "Description of signs" shows different categories of the degree of danger or damage that may occur due to wrong handling. "Description of symbols" shows the meaning of the symbols.

Important notes

- This book is only a guide for user's operation, not a criterion for configuration.
- Only use attachments/accessories specified by the manufacturer.



The lightning flash with arrowhead symbol, within an equilateral triangle, is intended to alert the user to the presence of uninsulated "dangerous voltage" within the product's enclosure that may be of sufficient magnitude to constitute a risk of electric shock to persons.



The exclamation point within an equilateral triangle is intended to alert the user to the presence of important operating and maintenance (servicing) instructions in the literature accompanying the appliance.



Warning: To reduce the risk of electric shock, do not remove cover (or back). NO user-serviceable parts inside. Refer RISK servicing to qualified service personnel.



This symbol indicates that this product incorporates double insulation between hazardous mains voltage and user accessible parts.

■ WARNING

- Minimum 5cm around the apparatus for sufficient ventilation.
- The ventilation should not be impeded by covering the ventilation openings with items, such as newspapers, table-cloths, curtains, etc.
- No naked flame sources, such as lighted candles, should be placed on the apparatus.

Description of signs



WARNING

Indicates that there is a risk of death or serious injury.



CAUTION

Indicates that there is a risk of light injury or property damage.

Description of symbols



Indicates "Prohibition" or "You must not do" with pictures and text.



Indicates "Mandatory Action" or "Do as indicated" with pictures and text.

What to do in the case of an abnormality



WARNING

- Stop using the device immediately in the case of an abnormality or failure.
- Remove the power plug from the receptacle immediately when any water or foreign object enters the interior of the device.
It may cause a fire or electric shock. Remove the power plug immediately, and contact your dealer for a repair.



What to do in the case of an abnormality



WARNING

- Stop using the device immediately in the case of an abnormality or failure.
- Remove the power plug from the receptacle immediately when any water or foreign object enters the interior of the device.
It may cause a fire or electric shock. Remove the power plug immediately, and contact your dealer for a repair.



Power cord and power plug



WARNING

- If any dust exists on the power plug pin or pin installation surface, remove the power plug and remove the dust.
- The mains plug is used as disconnect device, the disconnect device shall remain readily operable.
- Observe the following when handling the power cord.
 - Do not damage it. •Do not modify it (e.g. extension).
 - Do not heat it. •Do not pull it. •Do not place a heavy object on it. •Do not pinch it. •Do not bend it forcefully.
 - Do not twist it. •Do not bundle it.
 Doing so may cause a fire or electric shock.



- Do not insert or remove the power plug with a wet hand.
Doing so may cause a fire or electric shock.



CAUTION

- When removing the power plug from the receptacle, hold the power plug.
- If the device will not be used for a long time, remove the power plug from the receptacle.
Doing so may cause a fire or electric shock.
- Do not use any power cord other than the one that comes with the device.
- Do not use the power cord that comes with the device for any other product.
Doing so may cause a fire or electric shock.



Usage



WARNING

- Do not disassemble, repair, or modify the device.
- Do not insert any foreign object.
- When lightning starts, do not touch the antenna or power cord.
Doing so may cause a fire or electric shock.
- The use of apparatus in moderate climates.



CAUTION

- Before carrying the device, retract the antenna and remove the power plug from the receptacle.
Failure to do so may cause a fire, electric shock, or injury.
- Do not get on top of the device.
- Do not place a heavy object on the device.
- Do not block the ventilation hole.
- When the appliance coupler is used as the disconnect device, the appliance coupler shall remain readily operable.
- To prevent possible hearing damage, do not listen at high volume levels for long periods.
Doing so may cause an injury or fire.



If you leave the unit unused for a long period of time, the built-in rechargeable battery will be in an over discharge state due to self discharge, and the charging capacity may deteriorate or the battery may be no longer rechargeable. Even if you are not using the unit, charge the battery once or twice a year for 7 hours each time.

Installation



WARNING

- Place the unit on a flat surface away from sources of direct sunlight or excessive heat.
- Do not install the device in a confined or build-in space such as a book case or similar area, and keep it under a well-ventilated condition. The ventilation should not be impeded by covering the ventilation openings with items such as newspaper, table-cloths, curtains, etc.



- Do not expose the device to rain, moisture, dripping, or splashing.
- Do not place objects filled with liquids, such as vases, on the device.

Doing so may cause a fire or electric shock.



- The mains plug is used as disconnect device, the disconnect device shall remain readily operable.

Doing so may cause a fire or electric shock.

Notes

- If any color shift occurs on a nearby TV or the radio of this device picks up noise from the TV, keep this device away from the TV.

Disclaimer

- Toshiba shall not be responsible for any damage caused by an earthquake, thunderstorm, flood damage, fire for which Toshiba is not responsible, acts of a third party, other accidents, or damages caused by the user's willful acts or negligence, misuse, or use in abnormal conditions.
- Toshiba shall not be responsible for any damage caused by failure to observe the information described in the operation manual.

Disposal

- When disposing of the device, observe the laws, or ordinances and rules of the local government.

Disposal

- Do not dispose of lead acid batteries except through channels in accordance with local, state and federal regulations.
- It is illegal to dump lead-acid batteries in landfills or dispose of improperly. Please help our Earth by contacting the environmental protection agencies in your area, the battery manufacturer, or call Toshiba toll-free at (800)231-1412 for more information about recycling.

About using Bluetooth®

This unit is designed for use with Bluetooth® wireless devices compatible with the A2DP and AVRCP streaming audio profiles. Refer to your Bluetooth® device's user manual or technical support to determine if your Bluetooth® device supports these profiles.

■ Frequency band used

This unit uses the 2.4 GHz frequency band. However other wireless devices may use 2.4 GHz frequency band as well and may cause interference with each other. To avoid interference, please refrain from the use of the unit at the same time with other wireless devices.

■ Certification of this device

This unit conforms to frequency restrictions and has received certification based on frequency laws, so a wireless permit is not necessary.

However, the following action is punishable by law in some countries:

- Taking apart/modifying the unit.

■ Usage restrictions

- Wireless transmission and/or use with all Bluetooth® equipped devices is not guaranteed.
- A device featuring the Bluetooth® function is required to conform to the Bluetooth® standard specified by Bluetooth SIG, and be authenticated. Even if the connected device conforms to the above mentioned Bluetooth® standard, some devices may not be connected or work correctly, depending on the features or specifications of the device.

■ Range of use

Use this device within an unobstructed 10 m range. The range of use or perimeter may be shortened depending on any obstructions, devices causing interference, other people in the room, or the construction of the building. Please note that the range mentioned above is not guaranteed.

The Bluetooth® word mark and logos are owned by the Bluetooth SIG, Inc. and are used under license.

Charging the battery

This unit has a built-in Lead Acid rechargeable battery.

- 1 To start charging the battery, connect the supplied AC cord to the socket on the back of the unit, then insert the plug into an AC receptacle.

The CHARGE indicator lights up in red while the battery is charging. When the battery is fully charged (around 6 to 7 hours), the CHARGE indicator turns green. When the battery voltage is low and needs to be recharged, the CHARGE indicator flashes red.

Part names

- | | |
|---------------------------|---------------------------|
| 1 BASS button | 14 ► / / AUTO button |
| 2 USB CHARGE port | 15 ◀◀ / TUN. - button |
| 3 3.5mm AUX INPUT jack | 16 - (10/M./FOLD.) button |
| 4 6.3 mm MIC 1 jack | 17 P-MODE / M. button |
| 5 6.3 mm MIC 2 jack | 18 MIC. VOL. knob |
| 6 USB port | 19 CHARGE indicator |
| 7 POWER switch | 20 PAIR indicator |
| 8 LIGHT button | 21 DISPLAY |
| 9 ECHO button | 22 EQ button |
| 10 VOLUME knob | 23 FM ANTENNA |
| 11 FUNCTION / | 24 AC POWER socket |
| 12 + (10/M./FOLD.) button | 25 Wired microphone |
| 13 ►► / TUN.+ button | |

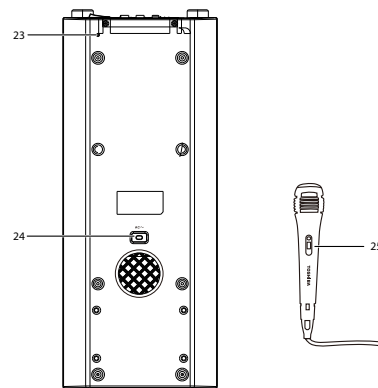
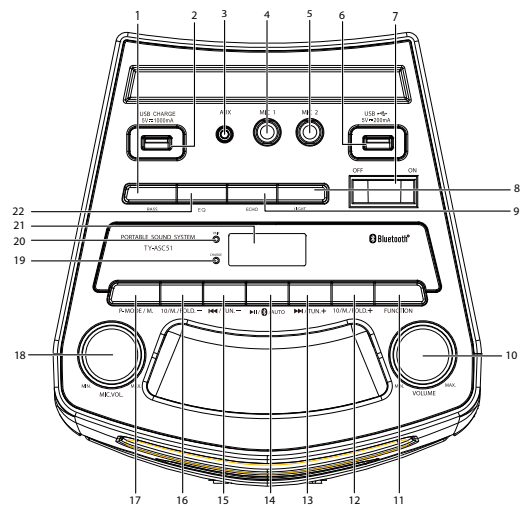

Basic functions

■ Turning the unit on/off

- 1 Turn the POWER switch to the ON or OFF position to turn the unit on/off.

Notes

• In USB/Bluetooth®/AUX mode, when no operation is performed for 15 minutes, the unit will automatically enter standby mode. To resume operation, press the FUNCTION /  button. Alternatively, turn the POWER switch to the OFF position and then switch to the ON position again to turn the unit on.

■ Setting the function mode

- 1 To change the function mode, press the FUNCTION button on the unit to select the USB /Bluetooth®/ AUX/FM function.

■ Adjusting the volume

- 1 Rotate the VOLUME knob on the unit to increase or decrease the volume.
Current volume level will be shown on the display.

■ Disco light function

- 1 Press the LIGHT button repeatedly to select the different lighting mode (L-1 to L-8 and OFF) of LED indicator light on the speaker.
 - L-1: Blue light flashing
 - L-2: Red light flashing
 - L-3: Green light flashing
 - L-4: Violet light flashing
 - L-5: Yellow light flashing
 - L-6: Light Blue light flashing
 - L-7: White light flashing
 - L-8: 7 color light flashingThe color changes to blue, red, green, violet, yellow, light blue, white and then to continuously changing between the 7 different colors.

■ Equalizer function

- 1 Press the EQ button repeatedly to select the different equalizer mode. Select the mode (FLAT, POP, CLASSIC, JAZZ and ROCK) that best matches the music style. The display will show the selected equalizer mode (either "FLAT", "POP", "CLASSIC", "JAZZ" or "ROCK").

■ Bass

- 1 Press BASS button to switch the bass on/off.
The "BASS" will be shown on the display when switched on.









■ Microphone echo

- 1 Press ECHO button to switch the microphone echo on/off.
The "ECHO" will be shown on the display when switched on.

USB operation

■ Listening to a USB device



This unit provides a USB port for music playback.

- 1 Press the FUNCTION button on the unit to select USB mode.
- 2 Connect a USB memory stick to the USB port on the top of the unit.
The display will show the total number of folders for 2 seconds and then show the total number of playable tracks on the USB device.
- 3 To playback and resume playback, press the  /  / AUTO button.
The elapsed time and the "▶" will be shown on the display.
- 4 To pause playback, press the  /  / AUTO button on the unit.
The elapsed time and the "▶" will be displayed blinking on the display.
- 5 To select a desired track, press the  / TUN.+ or  / TUN.- button either while playing or while paused until the desired track appears on the display.
The unit will start playing automatically.
- 6 To search for a particular passage during playback, press and hold the  / TUN.+ or  / TUN.- button to fast forward and fast backward until the desired point (passage) is reached, then release the button for normal playback.
Playback will start again from this point.
- 7 To jump to +/- 10 track, press the + or - (10/M./FOLD.) button.
- 8 To select +/- folder, press and hold the + or - (10/M./FOLD.) button.



Caution

• To prevent harmful interference, always connect USB devices directly to the unit. Do not use a USB extension cable to connect USB devices to the unit.



■ To Repeat a Single Track

- 1 Press the P-MODE / M. button on the unit during play.
The display will show "" and the current track will be played repeatedly.
- 2 To cancel repeat play, press the P-MODE / M. button on the unit until "" disappears from the display.

■ To repeat the folder

- 1 Press the P-MODE / M. button on the unit until " FOLDER" appears on the display.
The current folder will be repeated continuously.
- 2 To cancel repeat play, press the P-MODE / M. button on the unit until " FOLDER" disappears from the display.

■ To repeat all the Tracks

- 1 Press the P-MODE / M. button on the unit until " appears on the display.
All tracks on the USB device will be played repeatedly.
- 2 To cancel repeat play, press the P-MODE / M. button on the unit until " disappears from the display.

Obsah je uzamčen

Dokončete, prosím, proces objednávky.

Následně budete mít přístup k celému dokumentu.



Proč je dokument uzamčen? Nahněvat Vás rozhodně nechceme. Jsou k tomu dva hlavní důvody:

- 1) Vytvořit a udržovat obsáhlou databázi návodů stojí nejen spoustu úsilí a času, ale i finanční prostředky. Dělali byste to Vy zadarmo? Ne*. Zakoupením této služby obdržíte úplný návod a podpoříte provoz a rozvoj našich stránek. Třeba se Vám to bude ještě někdy hodit.

**) Možná zpočátku ano. Ale vězte, že dotovat to dlouhodobě nelze. A rozhodně na tom nezbohatneme.*

- 2) Pak jsou tady „roboti“, kteří se přiživují na naší práci a „vysávají“ výsledky našeho úsilí pro svůj prospěch. Tímto krokem se jim to snažíme překazit.

A pokud nemáte zájem, respektujeme to. Urgujte svého prodejce. A když neuspějete, rádi Vás uvidíme!