

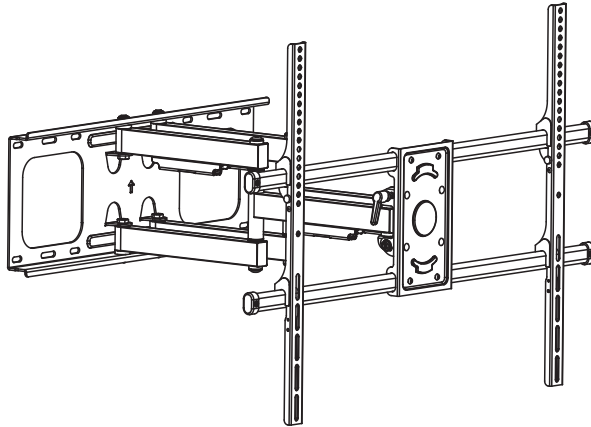

SHO 8610 PROFI



| | | | |
|----|----|-------|----|
| CZ | 8 | FR | 16 |
| SK | 9 | NL | 17 |
| HU | 10 | RU | 18 |
| PL | 11 | LT | 19 |
| EN | 12 | HR/BS | 20 |
| DE | 13 | SR/ME | 21 |
| IT | 14 | E/Λ | 22 |
| ES | 15 | BG | 23 |



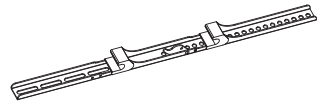
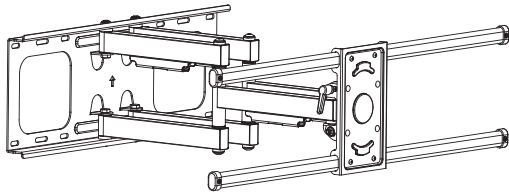

B (x2)

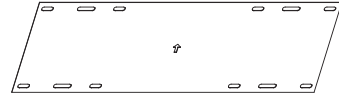

C (x1)



D (x2)



M5x14 (x4)
M-A



M6x14 (x4)
M-B

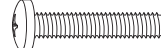

M6x30 (x4)
M-C

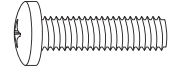

M8x30 (x4)
M-D



E (x1)

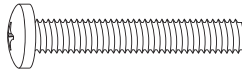

M8x50 (x4)
M-E



M-F (x4)



M-G (x8)



M-H (x8)



F (x1)

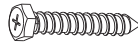

W-A (x6)

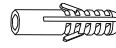

W-B (x6)



W-C (x6)

1a

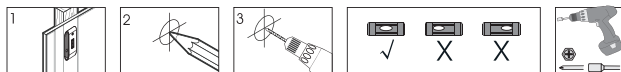
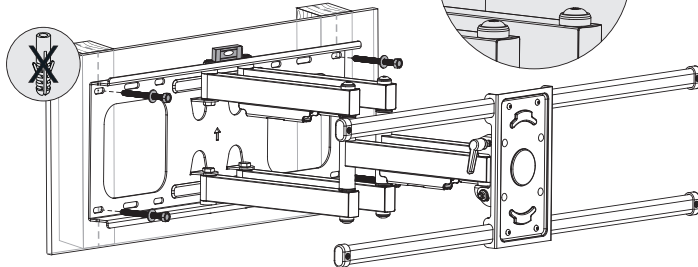
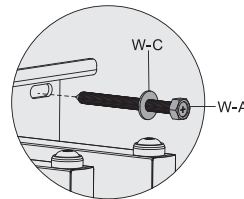
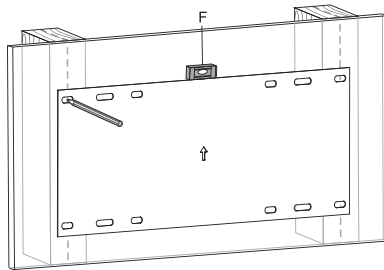
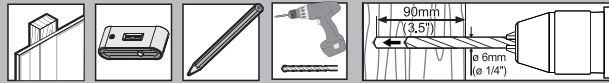

1b

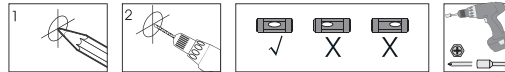
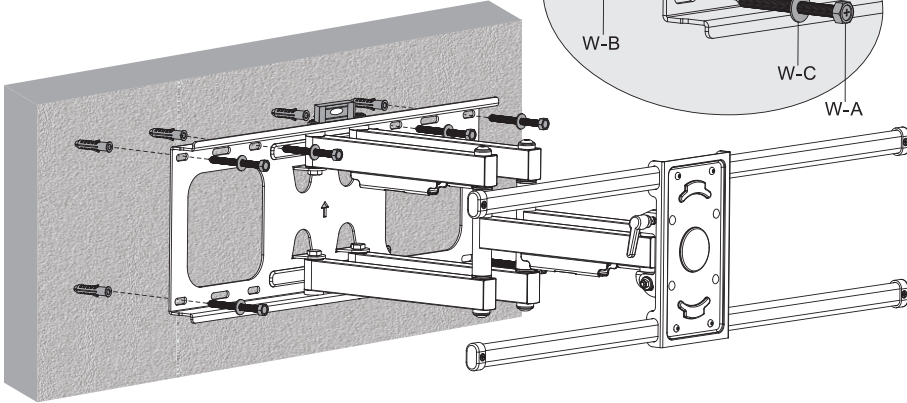
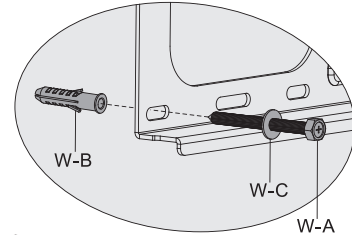
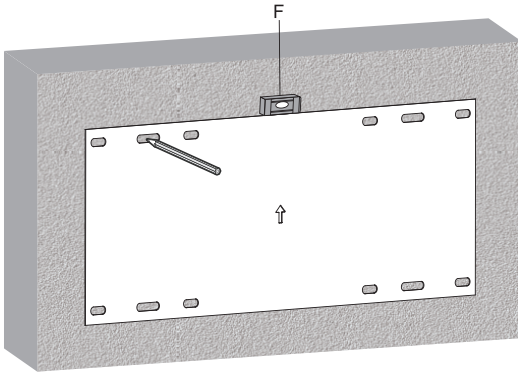
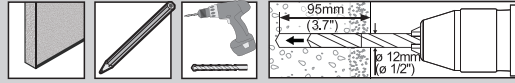

2a

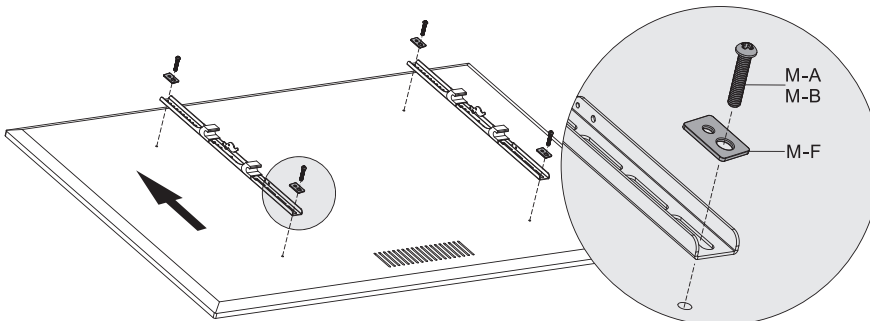
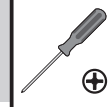

Obsah je uzamčen

Dokončete, prosím, proces objednávky.

Následně budete mít přístup k celému dokumentu.



Proč je dokument uzamčen? Nahněvat Vás rozhodně nechceme. Jsou k tomu dva hlavní důvody:

- 1) Vytvořit a udržovat obsáhlou databázi návodů stojí nejen spoustu úsilí a času, ale i finanční prostředky. Dělali byste to Vy zadarmo? Ne*. Zakoupením této služby obdržíte úplný návod a podpoříte provoz a rozvoj našich stránek. Třeba se Vám to bude ještě někdy hodit.

**) Možná zpočátku ano. Ale vězte, že dotovat to dlouhodobě nelze. A rozhodně na tom nezbohatneme.*

- 2) Pak jsou tady „roboti“, kteří se přiživují na naší práci a „vysávají“ výsledky našeho úsilí pro svůj prospěch. Tímto krokem se jim to snažíme překazit.

A pokud nemáte zájem, respektujeme to. Urgujte svého prodejce. A když neuspějete, rádi Vás uvidíme!