

# Panasonic<sup>®</sup>

## Operating Instructions

---

### Digital Corded/Cordless Phone

Model No. **KX-TGF310BX**

**KX-TGF310UE**

### Digital Corded/Cordless Answering System

Model No. **KX-TGF320BX**

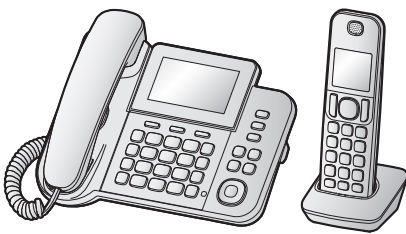

*Before initial use, see “Getting Started” on page 8.*

**Thank you for purchasing a Panasonic product.**

Please read these operating instructions before using the unit and save them for future reference.

## Table of Contents

<b>Introduction</b>		
Model composition .....	3	
Accessory information .....	3	
<b>Important Information</b>		
For your safety .....	5	
Important safety instructions .....	6	
For best performance .....	6	
Other information .....	7	
Specifications .....	7	
<b>Getting Started</b>		
Setting up .....	8	
Controls .....	11	
Display icons .....	13	
Turning the power on/off .....	14	
Language setting .....	14	
Date and time .....	14	
Recording your greeting message .....	14	
Other settings .....	15	
<b>Making/Answering Calls</b>		
Making calls .....	16	
Answering calls .....	17	
Useful features during a call .....	17	
Intercom .....	19	
Key lock .....	20	
<b>Nuisance Call Block</b>		
Using the call block button .....	21	
Storing unwanted callers .....	21	
<b>Phonebook</b>		
Phonebook .....	23	
Speed dial .....	24	
One-touch dial buttons .....	26	
<b>Programming</b>		
Menu list .....	27	
Alarm .....	33	
Do not disturb mode .....	33	
Baby monitor .....	34	
Other programming .....	36	
Registering a unit .....	37	
<b>Caller ID Service</b>		
Using Caller ID service .....	39	
Caller list .....	39	
<b>Answering System</b>		
Answering system .....	41	
Turning the answering system on/off .....	41	
Greeting message .....	41	
Listening to messages .....	42	
Advanced new message alerting features .....	43	
Remote operation .....	45	
Answering system settings .....	46	
<b>Useful Information</b>		
Voicemail service .....	48	
Wall mounting .....	48	
Character entry .....	49	
Error messages .....	51	
Troubleshooting .....	51	
<b>Index</b>		
Index .....	55	

## Model composition

Series	Model No.	Base unit	Handset	
		Part No.	Part No.	Quantity
KX-TGF310 series	KX-TGF310	KX-TGF310	KX-TGFA30	1
KX-TGF320 series	KX-TGF320	KX-TGF320	KX-TGFA30	1

## Accessory information

### Supplied accessories

No.	Accessory item/Part number	Quantity
①	AC adaptor for base unit*1	1
②	Telephone line cord	1
③	Desk stand/Wall mounting adaptor*2	1
④	Corded handset	1
⑤	Corded handset cord	1
⑥	Rechargeable batteries*3	2
⑦	Handset cover*4	1
⑧	Belt clip	1
⑨	Charger	1
⑩	AC adaptor for charger*5	1

\*1 PNLV226BX: KX-TGF310BX/KX-TGF320BX  
PNLV226E: KX-TGF310UE

\*2 The desk stand/wall mounting adaptor comes attached to the base unit.

\*3 See page 4 for replacement battery information.

\*4 The handset cover comes attached to the handset.

\*5 PNLV233BX: KX-TGF310BX/KX-TGF320BX  
PNLV233E: KX-TGF310UE

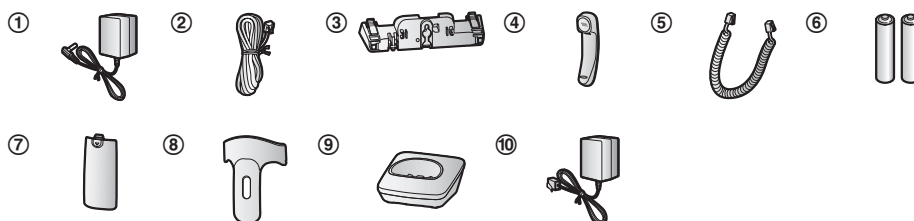

## Introduction

### Additional/replacement accessories

Please contact your nearest Panasonic dealer for sales information.

Accessory item	Model number/Specifications
Rechargeable batteries*1	Battery type: <ul style="list-style-type: none"><li>– Nickel metal hydride (Ni-MH)</li><li>– 2 x AAA (R03) size for each handset</li><li>– 1.2 V</li><li>– Minimum amperage of 550 mAh</li></ul>
Headset	RP-TCA400, RP-TCA430
DECT repeater	KX-A405, KX-A406
Key finder	KX-TGA20EX*2

\*1 Replacement batteries may have a different capacity from that of the supplied batteries.

We recommend using Panasonic rechargeable batteries.

\*2 By registering the key finder (4 max.) to a Panasonic Digital Cordless Phone and attaching it to an easy-to-lose item in advance, you can locate and find the mislaid item to which the key finder is attached. Please visit our Web site:

[www.panasonic.net/pcc/products/telephone/p/tga20/](http://www.panasonic.net/pcc/products/telephone/p/tga20/)

Please contact Panasonic or authorised sales department for availability of key finder in your area.

### Other information

- Design and specifications are subject to change without notice.
- The illustrations in these instructions may vary slightly from the actual product.

### Expanding your phone system

Handset (optional): KX-TGFA30BX*1	
You can expand your phone system by registering optional handsets (6 max.) to a single base unit. <ul style="list-style-type: none"><li>• Optional handsets may be a different colour from that of the supplied handsets.</li></ul>	

\*1 Available for: KX-TGF310BX/KX-TGF320BX

## For your safety

To prevent severe injury and loss of life/property, read this section carefully before using the product to ensure proper and safe operation of your product.

### **WARNING**

#### **Power connection**

- Use only the power source marked on the product.
- Do not overload power outlets and extension cords. This can result in the risk of fire or electric shock.
- Completely insert the AC adaptor/power plug into the power outlet. Failure to do so may cause electric shock and/or excessive heat resulting in a fire.
- Regularly remove any dust, etc. from the AC adaptor/power plug by pulling it from the power outlet, then wiping with a dry cloth. Accumulated dust may cause an insulation defect from moisture, etc. resulting in a fire.
- Unplug the product from power outlets if it emits smoke, an abnormal smell, or makes an unusual noise. These conditions can cause fire or electric shock. Confirm that smoke has stopped emitting and contact an authorised service centre.
- Unplug from power outlets and never touch the inside of the product if its casing has been broken open.
- Never touch the plug with wet hands. Danger of electric shock exists.

#### **Installation**

- To prevent the risk of fire or electrical shock, do not expose the product to rain or any type of moisture.
- Do not place or use this product near automatically controlled devices such as automatic doors and fire alarms. Radio waves emitted from this product may cause such devices to malfunction resulting in an accident.
- Do not allow the AC adaptor or telephone line cord to be excessively pulled, bent or placed under heavy objects.

#### **Operating safeguards**

- Unplug the product from power outlets before cleaning. Do not use liquid or aerosol cleaners.
- Do not disassemble the product.
- Do not spill liquids (detergents, cleansers, etc.) onto the telephone line cord plug, or allow it to become wet at all. This may cause a fire. If the telephone line cord plug becomes wet, immediately pull it from the telephone wall jack, and do not use.
- Do not excessively pull the corded handset cord from the base unit. This may cause the base unit to fall, resulting in injury.

#### **Medical**

- Consult the manufacturer of any personal medical devices, such as pacemakers or hearing aids, to determine if they are adequately shielded from external RF (radio frequency) energy. (The product operates in the frequency range of 1.88 GHz to 1.90 GHz, and the RF transmission power is 250 mW (max.).)
- Do not use the product in health care facilities if any regulations posted in the area instruct you not to do so. Hospitals or health care facilities may be using equipment that could be sensitive to external RF energy.

### **CAUTION**

#### **Installation and location**

- Never install telephone wiring during an electrical storm.
- Never install telephone line jacks in wet locations unless the jack is specifically designed for wet locations.
- Never touch uninsulated telephone wires or terminals unless the telephone line has been disconnected at the network interface.
- Use caution when installing or modifying telephone lines.
- The AC adaptor is used as the main disconnect device. Ensure that the AC outlet is installed near the product and is easily accessible.
- This cordless handset is unable to make calls when:
  - the handset batteries need recharging or have failed.
  - there is a power failure.
  - the key lock feature is turned on.

## Important Information

### Ni-MH rechargeable batteries

- We recommend using the batteries noted on page 4. **USE ONLY rechargeable Ni-MH batteries AAA (R03) size.**
- Do not mix old and new batteries.
- Do not open or mutilate the batteries. Released electrolyte from the batteries is corrosive and may cause burns or injury to the eyes or skin. The electrolyte is toxic and may be harmful if swallowed.
- Exercise care when handling the batteries. Do not allow conductive materials such as rings, bracelets, or keys to touch the batteries, otherwise a short circuit may cause the batteries and/or the conductive material to overheat and cause burns.
- Charge the batteries provided with or identified for use with this product only, in accordance with the instructions and limitations specified in this manual.
- Only use a compatible base unit (or charger) to charge the batteries. Do not tamper with the base unit (or charger). Failure to follow these instructions may cause the batteries to swell or explode.

### Note when using alkaline batteries for power backup

- The batteries should be used correctly, otherwise the unit may be damaged due to battery leakage.
- Do not charge, short-circuit, disassemble, or heat the batteries.
- Do not dispose of batteries in a fire.
- Remove all the batteries when replacing.
- Do not mix old, new or different types of batteries.
- It is recommended that batteries are replaced annually.
- It is recommended that batteries are replaced after a power outage.

## Important safety instructions

When using your product, basic safety precautions should always be followed to reduce the risk of fire, electric shock, and injury to persons, including the following:

1. Do not use this product near water for example, near a bathtub, washbowl, kitchen sink, or laundry tub, in a wet basement or near a swimming pool.

2. Avoid using a telephone (other than a cordless type) during an electrical storm. There may be a remote risk of electric shock from lightning.
3. Do not use the telephone to report a gas leak in the vicinity of the leak.
4. Use only the power cord and batteries indicated in this manual. Do not dispose of batteries in a fire. They may explode. Check with local codes for possible special disposal instructions.

### SAVE THESE INSTRUCTIONS

## For best performance

### Base unit location/avoiding noise

The base unit and other compatible Panasonic units use radio waves to communicate with each other.

- For maximum coverage and noise-free communications, place your base unit:
  - at a convenient, high, and central location with no obstructions between the cordless handset and base unit in an indoor environment.
  - away from electronic appliances such as TVs, radios, personal computers, wireless devices, or other phones.
  - facing away from radio frequency transmitters, such as external antennas of mobile phone cell stations. (Avoid putting the base unit on a bay window or near a window.)
- Coverage and voice quality depends on the local environmental conditions.
- If the reception for a base unit location is not satisfactory, move the base unit to another location for better reception.

### Environment

- Keep the product away from electrical noise generating devices, such as fluorescent lamps and motors.
- The product should be kept free from excessive smoke, dust, high temperature, and vibration.
- The product should not be exposed to direct sunlight.
- Do not place heavy objects on top of the product.
- When you leave the product unused for a long period of time, unplug the product from the power outlet.
- The product should be kept away from heat sources such as radiators, cookers, etc. It

should not be placed in rooms where the temperature is less than 0 °C or greater than 40 °C. Damp basements should also be avoided.

- The maximum calling distance may be shortened when the product is used in the following places: Near obstacles such as hills, tunnels, underground, near metal objects such as wire fences, etc.
- Operating the product near electrical appliances may cause interference. Move away from the electrical appliances.

#### Routine care

- Wipe the outer surface of the product with a soft moist cloth.
- Do not use benzine, thinner, or any abrasive powder.

### Other information

**CAUTION:** Risk of explosion if battery is replaced by an incorrect type. Dispose of used batteries according to the instructions.

#### Notice for product disposal, transfer, or return

- This product can store your private/confidential information. To protect your privacy/confidentiality, we recommend that you erase information such as phonebook or caller list entries from the memory before you dispose of, transfer, or return the product.

#### Information on Disposal in other Countries outside the European Union



These symbols are only valid in the European Union. If you wish to discard these items, please contact your local authorities or dealer and ask for the correct method of disposal.

#### Note for the battery removal procedure

Refer to "Handset battery installation" on page 8 and "Base unit battery installation (for power backup)" on page 9.

### Specifications

- **Standard:**  
DECT (Digital Enhanced Cordless Telecommunications),  
GAP (Generic Access Profile)
  - **Frequency range:**  
1.88 GHz to 1.90 GHz
  - **RF transmission power:**  
Approx. 10 mW (average power per channel)
  - **Power source:**  
100–240 V AC, 50/60 Hz\*1  
220–240 V AC, 50/60 Hz\*2
  - **Power consumption:**  
**Base unit\*3:**  
Standby: Approx. 0.5 W  
Maximum: Approx. 2.8 W  
**Base unit\*4:**  
Standby: Approx. 0.6 W  
Maximum: Approx. 2.8 W  
**Charger:**  
Standby: Approx. 0.12 W  
Maximum: Approx. 1.8 W
  - **Operating conditions:**  
0 °C–40 °C, 20 %–80 % relative air humidity (dry)
- \*1 KX-TGF310BX/KX-TGF320BX  
\*2 KX-TGF310UE  
\*3 KX-TGF310 series: page 3  
\*4 KX-TGF320 series: page 3

#### Note:

- The range of the handset under maximum conditions is 60 metres indoors and 300 metres outdoors. Please note it will probably be shortened when near concrete barriers, etc.

## Getting Started

### Setting up

#### Connections

##### ■ Base unit

- ① Connect the AC adaptor to the unit by pressing the plug firmly.
- ② Connect the telephone line cord to the unit until you hear a click.
- ③ Fasten the AC adaptor cord and the telephone line cord by hooking it.
- ④ Connect the AC adaptor to the power outlet.
- ⑤ Connect the telephone line cord to the telephone line jack until you hear a click.
- ⑥ A DSL/ADSL filter (not supplied) is required if you have a DSL/ADSL service.
- ⑦ Connect the corded handset cord to the corded handset and the base unit until you hear a click.

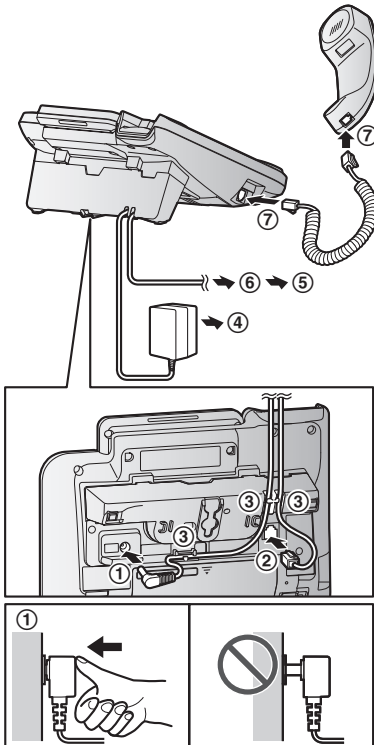

##### Note:

- Use only the supplied Panasonic AC adaptor.\*1
- Use only the supplied telephone line cord.

\*1 PNLV226BX: KX-TGF310BX/KX-TGF320BX  
PNLV226E: KX-TGF310UE

- Follow the directions on the display to set up the unit.

##### ■ Charger

- ① Connect the AC adaptor plug to the unit until you hear a click.
- ② Connect the AC adaptor to the power outlet.

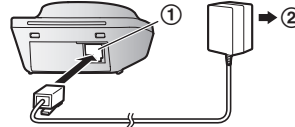

##### Note:

- Use only the supplied Panasonic AC adaptor.\*1
- \*1 PNLV233BX: KX-TGF310BX/KX-TGF320BX  
PNLV233E: KX-TGF310UE

#### Handset battery installation

- USE ONLY rechargeable Ni-MH batteries AAA (R03) size (A).
- Do NOT use alkaline/manganese/Ni-Cd batteries.
- Confirm correct polarities (⊕, ⊖).

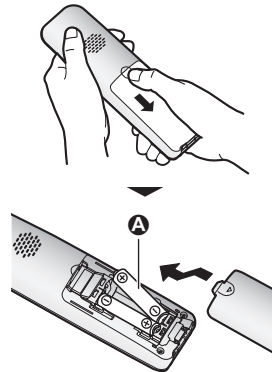

- Follow the directions on the display to set up the unit.



### Handset battery charging

Charge for about 7 hours.

- Confirm “Charging” is displayed (A).
- When the batteries are fully charged, “Fully Charged” is displayed.



### Handset battery level

Icon	Battery level
	High
	Medium
	Low
	Needs charging.

### Panasonic Ni-MH battery performance (supplied batteries)

Operation	Operating time
In continuous use	17 hours max.
Not in use (standby)	330 hours max.

**Note:**

- Actual battery performance depends on usage and ambient environment.

### Base unit battery installation (for power backup)

You can insert 2 AAA (R03) batteries (not supplied) into the base unit that will power the unit temporarily in the event of a power failure.

**Important:**

- The following batteries can be used with the base unit:
  - Rechargeable Ni-MH batteries\*1, \*2 (including the batteries used in your handset(s))
  - Standard (non-rechargeable) alkaline batteries\*3
- Do NOT use manganese batteries.

- Confirm correct polarities (⊕, ⊖).
- \*1 The base unit can fully charge Ni-MH batteries in about 15 hours.

- \*2 We recommend using Panasonic rechargeable batteries (page 4).
- \*3 Only insert alkaline batteries once a power failure occurs. Remove the alkaline batteries when power is restored.

- 1 Disconnect the telephone line cord (1).
- 2 Open the battery cover (2).
- 3 Install the batteries in the battery compartment (3).
- 4 Close the cover, then reconnect the telephone line cord (4).

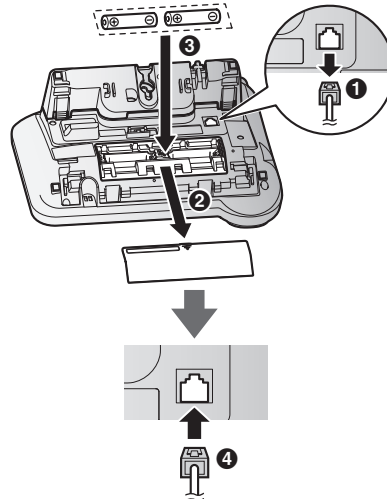

**Note:**

- If your phone service provider requires additional devices in order to make and receive calls, such as a modem, you may still not be able to make and receive calls even if the base unit's backup power feature is functioning.

### Base unit battery status when a power failure occurs

Icon	Battery status
	Power backup mode is on.
	Battery power is low.*1

- \*1 If begins flashing on the base unit, replace the batteries with new ones as soon as possible. If you replace Ni-MH batteries with

## Getting Started

alkaline batteries, insert the Ni-MH batteries into the base unit again after the power is restored so that they will be recharged.

### Battery saving mode setting

This feature allows the base unit to reduce its power consumption by limiting the available functions and therefore extend battery life during a power failure.

The following settings are available:

- “On” : The unit will work as a standard telephone. Only the corded handset can be used to make and receive calls. (You cannot use the base unit display, phonebook, one-touch dial, answering system, speakerphone, etc.)  
The base unit display is blank.
- “Off” (default): You can use the full functions of the base unit, but battery life is not extended. The brightness level for the base unit display is lowered.

### Base unit

- 1 [M] [#] 1 5 0
- 2 [↕]: Select the desired setting.
- 3 [OK] → [↔]

### Note:

- Once the battery saving mode is set to “On”, the unit rings with the volume level 1 even if the ringer volume for the base unit is set to “Off” to let you know an incoming call is being received.

### Panasonic Ni-MH battery performance (optional batteries) when operating on backup battery power

Operation	Saving mode	
	Off	On
In continuous use	3 hours max.	10 hours max.
Not in use (standby)	4 hours max.	12 hours max.

### Note:

- Battery performance depends on the type of batteries.
- Actual battery performance depends on usage and ambient environment.

## Note when setting up

### Note for connections

- The AC adaptor must remain connected at all times. (It is normal for the adaptor to feel warm during use.)
- The AC adaptor should be connected to a vertically oriented or floor-mounted AC outlet. Do not connect the AC adaptor to a ceiling-mounted AC outlet, as the weight of the adaptor may cause it to become disconnected.

### Note for Ni-MH battery installation

- **Handset:** Use the supplied rechargeable batteries.
- **Handset/Base unit:** For replacement, we recommend using the Panasonic rechargeable batteries noted on page 4, 6.

### Note for battery charging

- It is normal for the handset to feel warm during charging.
- Clean the charge contacts of the handset and charger with a soft and dry cloth once a month. Before cleaning the unit, disconnect from power outlets and any telephone line cords. Clean more often if the unit is exposed to grease, dust, or high humidity.

## Controls

### Handset

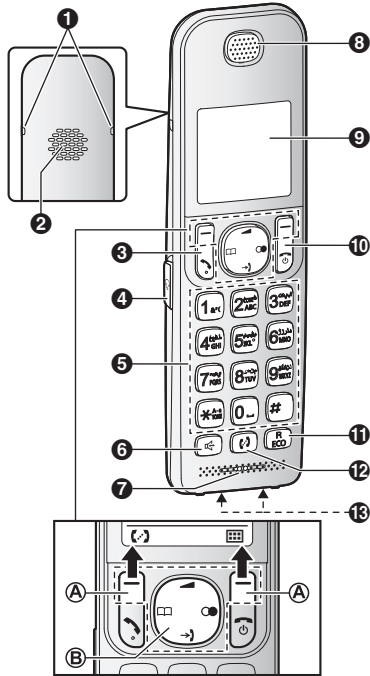

- 1 Belt clip holes
- 2 Speaker
- 3 **[Talk]** (Talk)
- 4 Headset jack
- 5 Dial keypad (**[TONE]**)
- 6 **[Speakerphone]** (Speakerphone)
- 7 Microphone
- 8 Receiver
- 9 Display
- 10 **[Off/Power]** (Off/Power)
- 11 **[R]** **[ECO]**  
R: Recall/Flash  
ECO: Eco mode shortcut key
- 12 **[Intercom]** (Intercom)
- 13 Charge contacts

#### Control type

##### A Soft keys

By pressing a soft key, you can select the feature shown directly above it on the display.

##### B Navigator key

Navigator keys functions as follows.

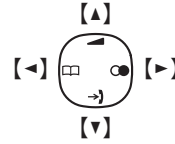

- **[▲]**, **[▼]**, **[▶]**, or **[▶]**: Scroll through various lists and items.
- **[▲]** or **[▼]** (**[▲]**): Adjust the receiver or speaker volume while talking.
- **[▶]** (Caller list): View the caller list.
- **[☐]** (Phonebook): View the phonebook entry.
- **[●]** (Redial): View the redial list.

### Base unit

#### ■ KX-TGF310 series: page 3

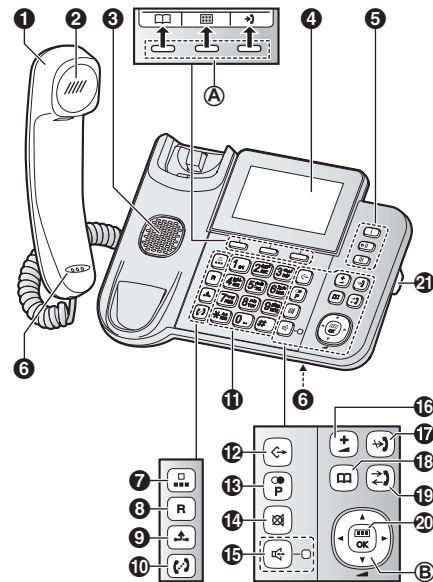

- 1 Corded handset
- 2 Receiver
- 3 Speaker
- 4 Display
  - The display can be moved back and forth to select the desired angle.
- 5 One touch dial buttons (**[I]**/**[II]**/**[III]**)
- 6 Microphone
- 7 **[Speed dial]** (Speed dial)
- 8 **[R]** (Recall/Flash)
- 9 **[Hold]** (Hold)

## Getting Started

- 10** **[📞]** (Locator/Intercom)
- You can locate a misplaced handset by pressing **[📞]**.
- 11** **Dial keypad** (**[☒]**: TONE)
- 12** **[↩]** (Exit)
- 13** **[🔄]** (Redial) **[P]** (Pause)
- 14** **[🔇]** (Mute)
- 15** **[📢]** (Speakerphone)  
Speakerphone indicator
- 16** **[±]** (Amplified volume)
- 17** **[🚫]** (Call block)
- 18** **[📖]** (Phonebook)
- 19** **[📞]** (Call log)
- You can access the caller list/redial list by pressing **[📞]**.
- 20** **[☰]** (Menu) **[OK]**
- 21** **Desk stand/Wall mounting adaptor**
- The adaptor is a removable attachment for desk stand or wall mounting use (page 48).

### ■ Control type

#### Ⓐ Soft keys

By pressing a soft key, you can select the feature shown directly above it on the display.

#### Ⓑ Navigator key

- [▲]**, **[▼]**, **[◀]**, or **[▶]**: Scroll through various lists and items.
- ◀** (**[▲]** or **[▼]**): Adjust the receiver or speaker volume while talking.

### ■ KX-TGF320 series: page 3

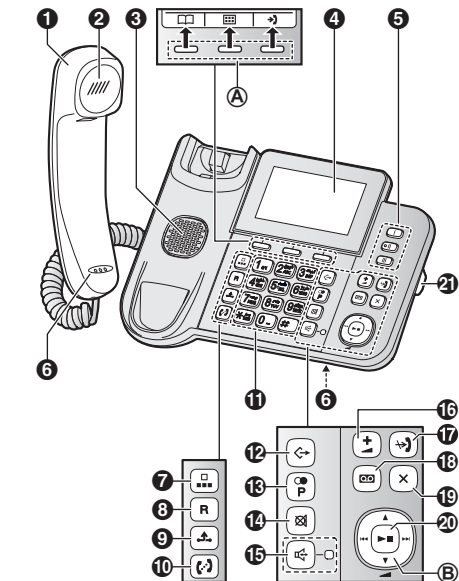

- 1** **Corded handset**
- 2** **Receiver**
- 3** **Speaker**
- 4** **Display**
- The display can be moved back and forth to select the desired angle.
- 5** **One touch dial buttons** (**[I]**/**[II]**/**[III]**)
- 6** **Microphone**
- 7** **[☰]** (Speed dial)
- 8** **[R]** (Recall/Flash)
- 9** **[⏸]** (Hold)
- 10** **[📞]** (Locator/Intercom)
- You can locate a misplaced handset by pressing **[📞]**.
- 11** **Dial keypad** (**[☒]**: TONE)
- 12** **[↩]** (Exit)
- 13** **[🔄]** (Redial) **[P]** (Pause)
- 14** **[🔇]** (Mute)
- 15** **[📢]** (Speakerphone)  
Speakerphone indicator
- 16** **[±]** (Amplified volume)
- 17** **[🚫]** (Call block)
- 18** **[📞]** (Answer on/off)  
Answer on/off indicator (**[📞]**)
- 19** **[X]** (Erase)
- 20** **[▶■]** (Play/Stop)  
Message indicator

**2) Desk stand/Wall mounting adaptor**

- The adaptor is a removable attachment for desk stand or wall mounting use (page 48).

**■ Control type**

**A Soft keys**

By pressing a soft key, you can select the feature shown directly above it on the display.

**B Navigator key**

- [▲], [▼], [◀], or [▶]: Scroll through various lists and items.
- ◀ ([▲] or [▼]): Adjust the receiver or speaker volume while talking.
- [◀]/[▶]: Repeat/skip messages during playback.

**Display icons**

**Display items**

Item	Meaning
*1	Range status: The more bars visible, the closer the handset is to the base unit.
*1	Out of base unit range
	Security for phone calls is set to "Enhanced". (page 37)
	Paging, intercom mode
*1	Speakerphone is on. (page 16)
*1 *2	The line is in use. • When flashing slowly: The call is put on hold. • When flashing rapidly: An incoming call is now being received.
*3	Missed call*3 (page 39)
	Eco mode is set to "Eco". (page 15)
*1	Noise reduction is set. (page 18)
*1	The LCD and key backlight is off. (page 30)
	• When displayed next to the battery icon: Answering system is on.*1, *4 (page 41) • When displayed with a number: New messages have been recorded.*4 (page 42)

Item	Meaning
	"Greeting Only" is selected. Caller messages are not recorded.*4 (page 47)
*1	Battery level
*2	Power backup mode is on. (page 9)
*1	Alarm is on. (page 33)
	Privacy mode is on. (page 30)
	Ringer volume is off. (page 29)
	Do not disturb mode is on. (page 33)
*3	Nuisance call blocked.*3 (page 21)
	New voicemail message received.*5 (page 48)
*1	Baby monitor is activated. The name/number displayed next to the icon indicates the monitoring unit. (page 34)
<b>Line in use</b>	Someone is using the line.
<b>IN USE</b>	Answering system is being used by another handset or the base unit.*4

- \*1 Handset
- \*2 Base unit
- \*3 Caller ID subscribers only
- \*4 KX-TGF320 series: page 3
- \*5 Voicemail subscribers only

**Soft key icons**

Icon	Action
	Returns to the previous screen or outside call.
	Displays the menu.
<b>OK</b>	Accepts the current selection.
	Makes a call. (page 16)
	Temporarily turns off the ringer for incoming calls. (page 17)
*1	Places a call on hold.
*1	Blocks calls from unwanted callers.
*2	Switches the screen to confirm the detailed information. (page 25)
*2	Opens the phonebook.

## Getting Started

Icon	Action
	Allows you to edit phone numbers. (page 22)
	Adds new entry. (page 21, 25)
1/A/Ä*2	Selects a character entry mode.
	Displays the phonebook search menu. (page 23)
*1	Turns the key lock feature off. (page 20)
*1	Stops alarm. (page 33)
*1	Snooze button on the alarm. (page 33)
✓	Selects entries or handsets. (page 33, 34)
*2	Opens the caller list.
■	Stops recording or playback.*3
	Stores phone numbers. (page 23)
×	Erases the selected item.
*1	Allows you to make an intercom call. (page 19)
*2	Establishes a conference call. (page 19)
C	Erases a number/character.
	Puts the call on mute.

\*1 Handset

\*2 Base unit

\*3 KX-TGF320 series: page 3

## Turning the power on/off

### Handset

Press for about 2 seconds.

## Language setting

### Display language

#### Handset / Base unit

- 1 #110
- 2 : Select your desired language. → [OK]
- 3 Proceed with the operation for your unit.  
Handset:

Base unit:

## Date and time

You can configure this setting using either the base unit or one of the handsets.

### Handset / Base unit

- 1 #101
- 2 Enter the current date, month, and year. → [OK]  
Example: 12 July, 2015  
120715
- 3 Enter the current hour and minute.  
Example: 15:30  
1530
- 4 [OK]
- 5 Proceed with the operation for your unit.  
Handset:   
Base unit:

### Note:

- The order in which you enter the date differs according to the selected display language.  
Example:  
Arabic/Persian: Year/Month/Date  
English: Date/Month/Year

## Recording your greeting message

### Available for:

KX-TGF320 series (page 3)

You can record your own greeting message instead of using a pre-recorded greeting message. See page 41 for details.

You can configure this setting using either the base unit or one of the handsets.

### Handset / Base unit

- 1 #302
- 2 : "Yes" → [OK]
- 3 Record a greeting message. →
- 4 Proceed with the operation for your unit.  
Handset:   
Base unit:

## Other settings

### Eco mode setting

#### Handset

You can select the desired eco mode setting by pressing **[ECO]**.

The following settings are available for eco mode.

- “**ECO**”: Reduces the base unit transmission power by up to 90 % in standby mode.  
When this setting is selected, **ECO** is displayed.\*1
- “**ECO OFF**” (default setting): Turns off eco mode.  
When this setting is selected, **ECO** is not displayed.

\*1 **Handset**: **ECO** is displayed instead of **Y**.

#### Note:

- When there is another cordless phone in use nearby, the base unit transmission power may not be reduced.
- When eco mode is active, the range of the base unit is reduced in standby mode.
- If you set repeater mode to “**On**” (page 38):
  - Eco mode is disabled.
  - “**Eco Mode**” is not displayed in the display menu (page 30).

### Dialling mode

If you cannot make calls, change this setting according to your telephone line service. The default setting is “**Tone**”.

“**Tone**”: For tone dial service.

“**Pulse**”: For rotary/pulse dial service.

You can configure this setting using either the base unit or one of the handsets.

#### Handset / Base unit

- 1 **[☰]#120**
- 2 **[↕]**: Select the desired setting. → **[OK]**
- 3 Proceed with the operation for your unit.  
**Handset**: **[☎]**  
**Base unit**: **[↔]**

## Making/Answering Calls

### Making calls

#### Using the handset

- 1 Lift the handset and dial the phone number.
  - To correct a digit, press [C].
- 2 [↶]
- 3 When you finish talking, press [⏻] or place the handset on the charger.

#### Using the speakerphone

- 1 Dial the phone number and press [📞].
- 2 When you finish talking, press [⏻].

#### Note:

- To switch back to the receiver, press [📞]/[↶].

#### Making a call using the redial list

The last 10 phone numbers dialed are stored in the redial list (each 24 digits max.).

- 1 [🔍]
- 2 [↕]: Select the desired entry.
- 3 [↶]

#### Erasing a number in the redial list

- 1 [🔍]
- 2 [↕]: Select the desired entry. → [X]
- 3 [↕]: "Yes" → [OK] → [⏻]

#### Using the base unit

- 1 Dial the phone number.
  - To correct a digit, press [C].
- 2 Lift the corded handset.
- 3 When you finish talking, place the corded handset on the cradle.

#### Note:

- You can also dial the phone number after lifting the corded handset.
- While on a call, you can switch from the base unit to the cordless handset as follows.  
The privacy mode must be off (page 30).
  - ① **Handset:** Press [↶].
  - ② **Base unit:** Place the corded handset on the cradle. When the speakerphone is used, press [📞].

#### Using the speakerphone

- 1 During a conversation with the corded handset, press [📞] to turn on the speakerphone.
  - You can place the corded handset on the cradle.
  - Speak into the base unit microphone.
- 2 When you finish talking, press [📞].

#### Note:

- To switch to the receiver, lift the corded handset.

#### Making a call using the redial list

The last 10 phone numbers dialed are stored in the redial list (each 24 digits max.).

- 1 [🔍]
- 2 [↕]: Select the desired entry.
- 3 Lift the corded handset.

#### Note:

- In step 1, you can also access the redial list as follows (KX-TGF310 series: page 3):  
[↶] → [↕]: "Outgoing Call" → [OK]

#### Erasing a number in the redial list

- 1 [🔍]
- 2 [↕]: Select the desired entry. → [X]
- 3 [↕]: "Yes" → [OK] → [↶]

#### Adjusting the receiver or speaker volume

##### Handset

Press [▲] or [▼] repeatedly while talking.

##### Base unit

Press [▲] or [▼] repeatedly while talking.

OR

Press [±] repeatedly while talking.

- Each press [±], receiver/speaker volume is increased by several levels.

#### Pause (for PBX/long distance service users)

A pause is sometimes required when making calls using a PBX or long distance service. When storing a calling card access number and/or PIN in the phonebook, a pause is also needed (page 24).



**Example:** If you need to dial the line access number "0" when making outside calls with a PBX:

### Handset

- 1 **0** → **[▲]** (Pause)
- 2 Dial the phone number. → **[↶]**

### Base unit

- 1 **0** → **[P]**
- 2 Dial the phone number.
- 3 Lift the corded handset.

#### Note for handset and base unit:

- A 3 second pause is inserted each time you press **[▲]** (Pause) on the handset or **[P]** on the base unit.

## Answering calls

### Using the handset

- 1 Lift the handset and press **[↶]** or **[📞]** when the unit rings.
- 2 When you finish talking, press **[📞]** or place the handset on the charger.

**Any key answer:** You can answer the call by pressing any dial key.

**Auto talk:** You can answer calls simply by lifting the handset (page 30).

**Temporary ringer off:** You can turn the ringer off temporarily by pressing **[🔕]**.

### Using the base unit

- 1 Lift the corded handset or press **[📞]** when the unit rings.
- 2 When you finish talking, place the corded handset on the cradle. When the speakerphone is used, press **[📞]**.

**Temporary ringer off:** You can turn the ringer off temporarily by pressing **[🔕]**.

### Adjusting the ringer volume

#### Handset

Press **[▲]** or **[▼]** repeatedly to select the desired volume while ringing.

#### Base unit

Press **[▲]** or **[▼]** repeatedly to select the desired volume while ringing.

OR

Press **[±]** repeatedly to select the desired volume while ringing.

- Each press **[±]**, ringer volume is increased by several levels.

## Useful features during a call

### Hold

#### Handset

- 1 Press **[📞]** during an outside call.
- 2 **[⇅]**: "Hold" → **[OK]**
- 3 To release hold, press **[↶]**.
  - Another handset user can take the call by pressing **[↶]**.
  - The base unit user can take the call by lifting the corded handset.

#### Base unit

- 1 Press **[↶]** during an outside call.
  - If you are using the corded handset, you can place it on the cradle.
- 2 To release hold, lift the corded handset.
  - A handset user can take the call by pressing **[↶]**.

#### Note for handset and base unit:

- While an outside call is on hold, the speakerphone indicator flashes.
- After holding for 10 minutes, the call is disconnected.

### Mute

#### Handset / Base unit

- 1 Press **[🔕]** during a call.
- 2 To return to the call, press **[🔕]**.

### Recall/flash

#### Handset / Base unit

**[R]** allows you to use the special features of your host PBX such as transferring an extension call, or accessing optional telephone services.

## Making/Answering Calls

### Note:

- To change the recall/flash time, see page 30.

### For call waiting or Call Waiting Caller ID service users

To use call waiting or Call Waiting Caller ID, you must first subscribe with your phone service provider.

This feature allows you to receive calls while you are already talking on the phone. If you receive a call while on the phone, you will hear a call waiting tone.

**If you subscribe to both Caller ID and Call Waiting with Caller ID services**, the 2nd caller's information is displayed on the handset or base unit that is in use after you hear the call waiting tone.

#### Handset / Base unit

- 1 Press **[R]** to answer the 2nd call.
- 2 To switch between calls, press **[R]**.

### Note:

- Please contact your phone service provider for details and availability of this service in your area.

### Temporary tone dialling (for rotary/pulse service users)

#### Handset / Base unit

Press **[X]** (TONE) before entering access numbers which require tone dialling.

### Handset noise reduction

This feature allows you to hear the voice of the person you are talking to more clearly, by reducing the surrounding noise coming from the other party's telephone.

- 1 Press **[M]** while talking.
- 2 **[↕]**: "Noise Reduction On" Or "Noise Reduction Off" → **[OK]**

### Note:

- Depending on the environment where this handset is being used, this feature may not be effective.
- This feature is not available while using the speakerphone.

### Handset equalizer

This feature clarifies the voice of the person you are talking to, producing a more natural-sounding voice that is easier to hear and understand.

- 1 Press **[M]** while talking.
- 2 **[↕]**: "Equalizer" → **[OK]**
- 3 **[↕]**: Select the desired setting.
- 4 Press **[OK]** to exit.

### Note:

- Depending on the condition and quality of your telephone line, this feature may emphasise existing line noise. If it becomes difficult to hear, turn this feature off.
- This feature is not available while using the speakerphone.

### Call share

You can join an existing outside call.

#### Handset

To join the conversation, press **[↵]** when the other unit is on an outside call.

#### Base unit

To join the conversation, lift the corded handset when the handset is on an outside call.

### Note for handset and base unit:

- To prevent other users from joining your conversations with outside callers, turn the privacy mode on (page 30).

### Transferring calls, conference calls

Outside calls can be transferred or a conference call with an outside party can be made:

- between 2 handsets
- between a handset and the base unit

#### Handset

- 1 During an outside call, press **[↵]**.  
**When 2 or more handsets are registered:**  
**[↕]**: Select the desired unit. → **[OK]**
- 2 Wait for the paged party to answer.
  - If the paged party does not answer, press **[↵]** to return to the outside call.
- 3 **To complete the transfer:**  
Press **[↵]**.

**To establish a conference call:**

[**☎**] → [**↕**]: “Conference” → [**OK**]

- To leave the conference, press [**☎**]. The other 2 parties can continue the conversation.
- To put the outside call on hold: [**☎**] → [**↕**]: “Hold” → [**OK**]  
To resume the conference: [**☎**] → [**↕**]: “Conference” → [**OK**]
- To cancel the conference: [**☎**] → [**↕**]: “Stop Conference” → [**OK**]  
You can continue the conversation with the outside caller.

**Base unit**

- 1 During an outside call, press [**☎**].  
**When 2 or more handsets are registered:** [**↕**]: Select the desired unit. → [**OK**]  
• To page all handsets, press [**☎**] or wait for a few seconds.
- 2 Wait for the paged party to answer.  
• If paged party does not answer, press [**☎**] to return to the outside call.
- 3 **To complete the transfer:**  
Place the corded handset on the cradle.  
• The outside call is being routed to the handset.  
**To establish a conference call:**  
Press [**☎**].  
• To leave the conference, place the corded handset on the cradle. The other 2 parties can continue the conversation.  
• To put the outside call on hold, press [**↕**]. To resume the conference, press [**☎**].

**Intercom**

Intercom calls can be made:  
– between handsets  
– between a handset and the base unit

**Note:**

- When paging unit(s), the paged unit(s) beeps for 1 minute.
- If you receive an outside call while talking on the intercom, the interrupt tone sounds.
  - **Handset:** To finish intercom, press [**☎**]. To answer the call, press [**☎**].
  - **Base unit:** To finish intercom, place the corded handset on the cradle. If the speakerphone is used, press [**☎**]. To answer

the call, lift the corded handset. If the speakerphone is used, press [**☎**].

**Making an intercom call**

**Handset**

- 1 [**☎**]  
**When 2 or more handsets are registered:** [**↕**]: Select the desired unit. → [**OK**]
- 2 When you finish talking, press [**☎**].

**Base unit**

- 1 [**☎**]  
**When 2 or more handsets are registered:** [**↕**]: Select the desired unit. → [**OK**]  
• To page all handsets, press [**☎**] or wait for a few seconds.  
• Lift the corded handset if needed.
- 2 When you finish talking, press [**☎**] or place the corded handset on the cradle.

**Answering an intercom call**

**Handset**

- 1 Press [**☎**] to answer the page.
- 2 When you finish talking, press [**☎**].

**Base unit**

- 1 Press [**☎**] or lift the corded handset to answer the page.
- 2 When you finish talking, press [**☎**] or place the corded handset on the cradle.

**Turning auto intercom on/off**

This feature allows the handset and base unit to answer intercom calls automatically when it is called. You do not need to press [**☎**], lift the corded handset, or press [**☎**]. When this feature is set to “On”, the monitoring handset or base unit for the baby monitor feature (page 35) will also answer baby monitor calls automatically. The default setting is “Off”.

**Handset / Base unit**

- 1 [**☎**]#273
- 2 [**↕**]: Select the desired setting. → [**OK**]
- 3 Proceed with the operation for your unit.  
**Handset:** [**☎**]

## Making/Answering Calls

---

Base unit: [↔]

### Key lock

#### Handset

The handset can be locked so that no calls or settings can be made. Incoming calls can be answered, but all other functions are disabled while key lock is on.

To turn key lock on, press [🔒] for about 3 seconds.

- To turn key lock off, press [🔓] for about 3 seconds.

#### Note:

- Calls to emergency numbers cannot be made until key lock is turned off.

## Using the call block button

You can press the [↔] in the following situation to disconnect the current call and add a phone number to the call block list:

- when an incoming call is being received
- when an incoming call is being recorded by the answering system
- when talking on an outside call on the base unit

Once a phone number has been added to the call block list, the unit will block calls from that phone number in the future.

### Handset / Base unit

- 1 Press [↔] under the situations shown above.
- 2 Confirm the call block number and press [OK].
  - The call block number is stored in the call block list, "Caller Blocked" is displayed, and then the call is disconnected.

### Note:

- If the call has no phone number, the call is blocked but it is not stored in the call block list.
- The call block feature is not available for the calls during call waiting or intercom call.
- Blocked calls are logged in the caller list.

## Storing unwanted callers

The unit can block calls by storing the desired items into the call block list beforehand (Caller ID subscribers only).

- "Single Number": The unit blocks calls from specific phone numbers stored in the call block list.
- "Range of Numbers": The unit blocks calls that begin with a number stored in the call block list, such as a toll-free phone number prefix or certain area codes.
- "Withheld": The unit blocks calls that have no phone number.

Single phone numbers and ranges of numbers can be stored in the call block list up to 100 items in total.

### Blocking unwanted callers:

When a call is received, the unit does not ring while the caller is being identified.

If the caller's phone number matches an entry in the call block list, the unit emits no sound to the caller, and disconnects the call.

## Storing a single phone number

### Important:

- You must include the area code when storing phone numbers in the call block list.

### Adding call blocked numbers from the caller list

#### Handset

- 1 [→]
- 2 [↓]: Select the entry to be blocked. → [☐]
- 3 [↓]: "Save Call Block" → [OK]
- 4 [↓]: "Yes" → [OK] → [☎]

#### Base unit

- 1 [→]
- 2 [↓]: Select the entry to be blocked.
- 3 [↔]
- 4 [↓]: "Yes" → [OK] → [↔]

### Adding call blocked numbers manually

#### Handset

- 1 [☐]#217
- 2 [↓]: "Single Number" → [OK]
- 3 [☐] → [↓]: "Add" → [OK]
- 4 Enter the phone number (24 digits max.).
- 5 [OK] → [☎]

#### Base unit

- 1 [↔]
- 2 [↓]: "Single Number" → [OK] → [☐↔]
- 3 Enter the phone number (24 digits max.).
- 4 [OK] → [↔]

## Storing a range of number

#### Handset

- 1 [☐]#217
- 2 [↓]: "Range of Numbers" → [OK]
- 3 [☐] → [↓]: "Add" → [OK]
- 4 Enter the desired number (2-8 digits).
- 5 [OK] → [☎]

## Nuisance Call Block

### Base unit

- 1 [↔]
- 2 [↕]: "Range of Numbers" → [OK]
- 3 [□↔]
- 4 Enter the desired number (2-8 digits).
- 5 [OK] → [↔]

### Blocking incoming calls that have no phone number

You can block calls when no phone number is provided, such as private callers.

### Handset

- 1 [☎]#240
- 2 [↕]: Select the desired setting. → [OK] → [🔇]

### Base unit

- 1 [↔]
- 2 [↕]: "Withheld" → [OK]
- 3 [↕]: Select the desired setting. → [OK] → [↔]

### Viewing/editing/erasing call block numbers

### Handset

- 1 [☎]#217
- 2 [↕]: "Single Number" or "Range of Numbers" → [OK]
- 3 [↕]: Select the desired entry.
  - After viewing, press [🔇] to exit.
- 4 **To edit a number:**  
[□☎] → Edit the number. → [OK] → [🔇]

### To erase a number:

[X] → [↕]: "Yes" → [OK] → [🔇]

### Base unit

- 1 [↔]
- 2 [↕]: "Single Number" or "Range of Numbers" → [OK]
- 3 [↕]: Select the desired entry.
  - After viewing, press [↔] to exit.
- 4 **To edit a number:**  
[□☎] → Edit the number. → [OK] → [↔]

### To erase a number:

[X] → [↕]: "Yes" → [OK] → [↔]

### Note:

- When editing, press the desired dial key to add digits and press [C] to erase digits.

### Erasing all call block numbers

### Handset

- 1 [☎]#217
- 2 [↕]: "Single Number" or "Range of Numbers" → [OK]
- 3 [☎] → [↕]: "Erase All" → [OK]
- 4 [↕]: "Yes" → [OK]
- 5 [↕]: "Yes" → [OK] → [🔇]

### Base unit

- 1 [↔]
- 2 [↕]: "Single Number" or "Range of Numbers" → [OK]
- 3 [X]
- 4 [↕]: "Yes" → [OK]
- 5 [↕]: "Yes" → [OK] → [↔]

## Phonebook

You can add 100 names (16 characters max.) and phone numbers (24 digits max.) to the phonebook, and assign each phonebook entry to the desired category (page 23).

### Important:

- All entries can be shared by the base unit and any registered handset.

## Adding phonebook entries

### Handset / Base unit

- 1 [☐] → [☐☐☐]
- 2 [↕]: "New Entry" → [OK]
- 3 Enter the party's name. → [OK]
  - You can change the character entry mode by pressing [ECO] on the handset or [1/A/Ä] on the base unit (page 49).
- 4 Enter the party's phone number. → [OK]
- 5 [↕]: Select the desired category. → [OK] 2 times
- 6 Proceed with the operation for your unit.  
Handset: [☎]  
Base unit: [↔]

### Note for base unit:

- You can also add entries as follows:  
Press [☐]. → [☐↔] → Go to step 3.

## Storing a redial list number to the phonebook

### Handset / Base unit

- 1 [☎]
- 2 [↕]: Select the desired entry. → [☐☐]
- 3 To store the name, continue from step 3, "Editing entries", page 24.

## Storing caller information to the phonebook

### Handset

- 1 [→]
- 2 [↕]: Select the desired entry. → [☐☐]
- 3 [↕]: "Save Phonebook" → [OK]
- 4 To store the name, continue from step 3, "Editing entries", page 24.

### Base unit

- 1 [→]
- 2 [↕]: Select the desired entry. → [☐☐]
- 3 [↕]: "Phonebook" → [OK]
- 4 To store the name, continue from step 3, "Editing entries", page 24.

## Categories

Categories can help you find entries in the phonebook quickly and easily. You can change the names of categories ("Friends", "Family", etc.). By assigning different ringer tones for different categories of callers, you can identify who is calling (category ringer tone), if you have subscribed to Caller ID service.

## Changing category names/setting category ringer tone

### Handset / Base unit

- 1 [☐] → [☐☐☐]
- 2 [↕]: "Category" → [OK]
- 3 [↕]: Select the desired category. → [OK]
- 4 **To change category names**  
[↕]: "Category Name" → [OK] → Edit the name (10 characters max.). → [OK]  
**To set category ringer tone (handset)**  
[↕]: Select the current setting of the category ringer tone. → [OK] → [↕]: Select the desired ringer tone. → [OK]
- 5 Proceed with the operation for your unit.  
Handset: [☎]  
Base unit: [↔]

## Finding and calling from a phonebook entry

### Handset / Base unit

- 1 [☐☐]
- 2 **To scroll through all entries**  
[↕]: Select the desired entry.  
**To search by first character**
  - ① Press the dial key ([0] to [9], or [#]) which contains the character you are searching for (page 49).
  - ② [↕]: Scroll through the phonebook if necessary.**To search by category**

## Phonebook

- ① [⌂] → [↕]: “Category” → [OK]
  - ② [↕]: Select the desired category. → [OK]
  - ③ [↕]: Scroll through the phonebook if necessary.
- 3 Proceed with the operation for your unit.  
**Handset:** [↵]  
**Base unit:** Lift the corded handset.

### Editing entries

#### Handset

- 1 Find the desired entry (page 23). → [⌂]
- 2 [↕]: “Edit” → [OK]
- 3 Edit the name if necessary. → [OK]
- 4 Edit the phone number if necessary. → [OK]
- 5 [↕]: Select the desired category (page 23). → [OK] 2 times → [↵]

#### Base unit

- 1 Find the desired entry (page 23).
- 2 [⌂]
- 3 Edit the name if necessary. → [OK]
- 4 Edit the phone number if necessary. → [OK]
- 5 [↕]: Select the desired category (page 23). → [OK] 2 times → [↵]

### Erasing entries

#### Erasing an entry

##### Handset

- 1 Find the desired entry (page 23). → [⌂]
- 2 [↕]: “Erase” → [OK]
- 3 [↕]: “Yes” → [OK] → [↵]

##### Base unit

- 1 Find the desired entry (page 23).
- 2 [X] → [↕]: “Yes” → [OK] → [↵]

#### Erasing all entries

##### Handset / Base unit

- 1 [⌂] → [⌂]
- 2 [↕]: “Erase All” → [OK]
- 3 [↕]: “Yes” → [OK]
- 4 [↕]: “Yes” → [OK]

- 5 Proceed with the operation for your unit.

**Handset:** [↵]  
**Base unit:** [↵]

### Chain dial

This feature allows you to dial phone numbers in the phonebook while you are on a call. This feature can be used, for example, to dial a calling card access number or bank account PIN that you have stored in the phonebook, without having to dial manually.

#### Handset / Base unit

- 1 During an outside call, press [⌂].
- 2 [↕]: Select the desired entry.
- 3 Proceed with the operation for your unit.  
**Handset:** [↵] (right soft key) to dial the number.  
**Base unit:** [↵] (middle soft key) to dial the number.

#### Note:

- When storing a calling card access number and your PIN in the phonebook as one phonebook entry, press [⏸] (Pause) on the handset or [P] on the base unit to add pauses after the number and PIN as necessary (page 16).
- If you have rotary/pulse service, you need to press [T] (TONE) before pressing [⌂] in step 1 to change the dialling mode temporarily to tone. When adding entries to the phonebook, we recommend adding [T] (TONE) to the beginning of phone numbers you wish to chain dial (page 23).

### Speed dial

You can store phone numbers to the base unit and handset separately:

- Handset: up to 9 entries.
- Base unit: up to 9 entries.

### Adding phone numbers to speed dial keys

#### Handset

You can assign 1 phone number to each of the dial keys ([1] to [9]).



■ **By entering phone numbers:**

- 1 Press and hold the desired speed dial key (1 to 9). → [OK]
- 2 [↕]: "Manual" → [OK]
- 3 Enter the party's name (16 characters max.). → [OK]
- 4 Enter the party's phone number (24 digits max.). → [OK] 2 times → [☎]

■ **From the phonebook:**

- 1 Press and hold the desired speed dial key (1 to 9). → [OK]
- 2 [↕]: "Phonebook" → [OK]
- 3 [↕]: Select the desired entry.
- 4 [OK] → [☎]

**Base unit**

■ **By entering phone numbers:**

- 1 [..]
- 2 [↕]: Select the desired speed dial key. → [OK]
- 3 Enter the party's name (16 characters max.). → [OK]
- 4 Enter the party's phone number (24 digits max.). → [OK] 2 times → [↔]

■ **From the phonebook:**

- 1 [..]
- 2 [↕]: Select the desired speed dial key. → [OK]
- 3 [↕]: Select the desired entry.
- 4 [OK] → [↔]

**Note for handset and base unit:**

- If you edit a phonebook entry which is assigned to a speed dial key, the edited entry does not transfer to the speed dial key.

**Note for base unit:**

- You can also select the desired entry as follows:
  - Press and hold the desired speed dial key (1 to 9).
  - Press [..] and then enter the desired speed dial key (1 to 9).

**Editing an entry**

**Handset**

- 1 Press and hold the desired speed dial key (1 to 9). → [OK]
- 2 [↕]: "Edit" → [OK]
- 3 Edit the name if necessary. → [OK]
- 4 Edit the phone number if necessary. → [OK] 2 times → [☎]

**Base unit**

- 1 [..]
- 2 [↕]: Select the desired entry. → [≡]
- 3 [OK]
- 4 Edit the name if necessary. → [OK]
- 5 Edit the phone number if necessary. → [OK] 2 times → [↔]

**Erasing an entry**

**Handset**

- 1 Press and hold the desired speed dial key (1 to 9). → [OK]
- 2 [↕]: "Erase" → [OK]
- 3 [↕]: "Yes" → [OK] → [☎]

**Base unit**

- 1 [..]
- 2 [↕]: Select the desired entry. → [≡]
- 3 [X]
- 4 [↕]: "Yes" → [OK] → [↔]

**Viewing an entry/Making a call**

**Handset**

- 1 Press and hold the desired speed dial key (1 to 9).
- 2 To make a call, press [☎].

**Base unit**

- 1 [..]
- 2 [↕]: Select the desired entry.
- 3 Lift the corded handset.

## Phonebook

### Note for base unit:

- You can dial phone numbers in the speed dial while you are on a call.

## One-touch dial buttons

You can store phone numbers to the base unit's one-touch dial buttons ([I] to [III]).

## Adding phone numbers for outside calls

### Base unit

#### ■ By entering phone numbers:

- 1 Press and hold the desired one-touch dial button ([I] to [III]). → [☎]
- 2 Enter the party's name (16 characters max.). → [OK]
- 3 Enter the party's phone number (24 digits max.). → [OK] 2 times → [↔]

#### ■ From the phonebook:

- 1 Press and hold the desired one-touch dial button ([I] to [III]).
- 2 [☐☐]
- 3 [↕]: Select the desired entry.
- 4 [OK] → [↔]

### Note:

- If you edit a phonebook entry which is assigned to a one-touch dial button, the edited entry does not transfer to the one-touch dial button.

## Viewing/editing/erasing an entry

### Base unit

- 1 Press and hold the desired one-touch dial button ([I] to [III]).
  - After viewing, press [↔] to exit.
- 2 **To edit an entry**  
[☎] → Edit the name if necessary. → [OK]  
→ Edit the phone number if necessary. → [OK] 2 times → [↔]  
**To erase an entry**  
[X] → [↕]: "Yes" → [OK] → [↔]

## Making a call

### Base unit

Press the desired one touch dial button ([I] to [III]), then lift the corded handset.

### Note:

- You can dial phone numbers in the one-touch dial while you are on a call.

## Menu list

To access the features, there are 2 methods.

### Handset / Base unit

#### ■ Scrolling through the display menus

- 1
- 2 **Handset:** Press **[▼]**, **[▲]**, **[▶]**, or **[◀]** to select the desired main menu. → **[OK]**  
**Base unit\*1:** Press **[▼]**, **[▲]**, **[▶▶]**, or **[◀◀]** to select the desired main menu. → **[OK]**
- 3 Press **[▼]** or **[▲]** to select the desired item from the next sub-menus. → **[OK]**
- 4 Press **[▼]** or **[▲]** to select the desired setting. → **[OK]**

\*1 Base unit navigator key is as follows.

Model No.	Left	Right
KX-TGF310	<b>[◀]</b>	<b>[▶]</b>
KX-TGF320	<b>[◀◀]</b>	<b>[▶▶]</b>

#### ■ Using the direct command code

- 1 → Enter the desired code.  
**Example:** Press #101.
- 2 Select the desired setting. → **[OK]**

#### Note:

- The unit column shows the unit(s) that can be used to program the item.
  - : Only the handset can program the item.
  - : Only the base unit can program the item.
  - : Both the handset and base unit can program the item.
- To exit the operation, press **[⏻]** on the handset or **[↩]** on the base unit.
- In the following table, < > indicates the default settings.
- In the following table, indicates the reference page number.
- Display menu order and sub-menu may vary depending on your model.

## Display the menu tree and direct command code table

### Main menu:

**Handset:** "Answer System"\*1

**Base unit:** "Answer System"\*1

Sub-menu 1	Sub-menu 2	Settings	Code	Unit	
Play New Message	–	–	#323		43
Play All Message	–	–	#324		43
Erase All Message*2	–	–	#325		43

## Programming

Sub-menu 1	Sub-menu 2	Settings	Code	Unit	
Greeting	Record Greeting* <sup>2</sup>	-	#302		41
	Play Greeting	-	#303		42
	Default* <sup>2</sup> (Reset to pre-recorded greeting)	-	#304		42
New Message Alert* <sup>2</sup>	Outgoing Call - On/Off	On <Off>	#338		43
	Outgoing Call - Notification to	-			
	Outgoing Call - Remote Code	Activate <Inactivate>			
	Base Unit Beep	On <Off>	#339		43
Settings	Number of Rings* <sup>2</sup>	2-7 Rings <4 Rings> Auto	#211		46
	Recording Time* <sup>2</sup>	1 Minute <3 Minutes> Greeting Only* <sup>3</sup>	#305		47
	Remote Code* <sup>2</sup>	-	#306		45
	Call Screening	<On> Off	#310		46
Answer On* <sup>2</sup>	-	-	#327		41
Answer Off* <sup>2</sup>	-	-	#328		41

### Main menu: "Time Settings"

Sub-menu 1	Sub-menu 2	Settings	Code	Unit	
Set Date/Time* <sup>2</sup>	-	-	#101		14
Memo Alarm	Alarm 1-3	Once Daily Weekly <Off>	#720		33
Time Adjustment* <sup>2</sup> , * <sup>4</sup>	-	Caller ID <Manual>	#226		-

### Main menu: "Caller List"\*<sup>5</sup>





















Operation	Code	Unit	
Viewing the caller list.	#213		39

## Programming

Main menu: "Initial Setup"

Sub-menu 1	Sub-menu 2	Settings	Code	Unit	
Ringer Setup	Ringer Volume	Off-6 <6>	#160		-
	Ringtone* <sup>6</sup>	<Ringtone 1>	#161		-
	Do Not Disturb Mode - On/Off	On <Off>	#238		33
	Do Not Disturb Mode - Start/End	<23:00/06:00>	#237		34
	Do Not Disturb Mode - Ring Delay	30 sec. <60 sec.> 90 sec. 120 sec. No Ringing	#239		34
	Do Not Disturb Mode - Select Category	Category 1-9	#241		34
	First Ring* <sup>2, 7</sup>	<On> Off	#173		-
Time Settings	Set Date/Time* <sup>2</sup>	-	#101		14
	Memo Alarm - Alarm 1-3	Once Daily Weekly <Off>	#720		33
	Time Adjustment* <sup>2, 4</sup>	Caller ID <Manual>	#226		-
Key Finder Setup* <sup>8</sup>  - 1:Add New Device (for Finder1)* <sup>9</sup>  - 2:Add New Device (for Finder2)  - 3:Add New Device (for Finder3)  - 4:Add New Device (for Finder4)	Change Name* <sup>2</sup>	Finder1	#6561		-
		Finder2* <sup>10</sup>	#6562* <sup>10</sup>		
		Finder3* <sup>10</sup>	#6563* <sup>10</sup>		
		Finder4* <sup>10</sup>	#6564* <sup>10</sup>		
	Register	-	#6571		-
			#6572* <sup>10</sup>		
			#6573* <sup>10</sup>		
			#6574* <sup>10</sup>		
	Cancel Register	-	#6581		-
			#6582* <sup>10</sup>		
		#6583* <sup>10</sup>			
		#6584* <sup>10</sup>			
Nuisance Call Block* <sup>2</sup>	Single Number	-	#217		21
	Range of Numbers	-			
	Withheld	On <Off>	#240		22

## Programming

Sub-menu 1	Sub-menu 2	Settings	Code	Unit	
One Touch Dial	-	-	#247		26
Speed Dial	-	-	#261		24
Eco Mode <sup>*2, *11</sup>	-	<Off> Eco	#725		15
Security <sup>*2, *11</sup>	-	<Normal> Enhanced	#729		37
Record Greeting <sup>*1, *2</sup>	-	-	#302		41
Display Setup	LCD & Key Backlight	<On> Off	#276		-
	Contrast (Display contrast)	Level 1-4 <2>	#145		-
	Handset Name	-	#104		36
	Display Name	On <Off>	#105		36
Contrast (Display contrast)	-	Level 1-6 <3>	#145		-
Auto Intercom	-	On <Off>	#273		19
Keytones	-	<On> Off	#165		-
Area Code <sup>*2</sup>	-	-	#255		36
Call Restrict <sup>*2</sup>	-	-	#256		36
Auto Talk <sup>*12</sup>	-	On <Off>	#200		17
Line Setup	Dial Mode <sup>*2</sup>	Pulse <Tone>	#120		15
	Recall/Flash <sup>*2, *13</sup>	900 msec. 700 msec. <600 msec.> 400 msec. 300 msec. 250 msec. 200 msec. 160 msec. 110 msec. 100 msec. 90 msec. 80 msec.	#121		17
Privacy Mode <sup>*2, *14</sup>	-	On <Off>	#194		-
Base Unit PIN <sup>*2</sup>	-	<0000>	#132		37
Repeater Mode <sup>*2</sup>	-	On <Off>	#138		38

## Programming

Sub-menu 1	Sub-menu 2	Settings	Code	Unit	👉
Register	Register Handset	–	#130		37
	Cancel Register*3	–	#131		37
Cancel Register*3	–	–	#131		37
Battery Saving Mode	–	On <Off>	#150		10
Language	Display	<English>	#110		14

Main menu: ☺ “Baby Monitor”\*15

Sub-menu 1	Sub-menu 2	Settings	Code	Unit	👉
On/Off	–	On <Off>	#268		34
Sensitivity Level	–	Low <Middle> High	#269		35

Main menu: Ⓜ “Key Finder”\*8, \*15

Sub-menu 1	Sub-menu 2	Settings	Code	Unit	👉
Search	–	–	#655		–
Battery Check	–	–			

Main menu: 🎵 “Ringer Setup”\*16



Sub-menu 1	Sub-menu 2	Settings	Code	Unit	👉
Ringer Volume	–	Off-6 <6>	#160		–
Ringtone*6	–	<Ringtone 1>	#161		–
Do Not Disturb Mode	On/Off	On <Off>	#238		33
	Start/End	<23:00/06:00>	#237		34
	Ring Delay	30 sec. <60 sec.> 90 sec. 120 sec. No Ringing	#239		34
	Select Category	Category 1-9	#241		34
First Ring*2, *7	–	<On> Off	#173		–

Main menu: 🗨 “Contrast”\*17



Sub-menu 1	Sub-menu 2	Settings	Code	Unit	👉
–	–	Level 1-6 <3>	#145		–

## Programming



Main menu:  "Nuisance Call Block"\*2, \*18

Sub-menu 1	Sub-menu 2	Settings	Code	Unit	
Single Number	–	–	#217		21
Range of Numbers	–	–			
Withheld	–	On <Off>	#240		22

Main menu:  "One Touch Dial"\*19

Operation	Code	Unit	
Storing/viewing the one touch dial entry.	#247		26

Main menu:  "Eco Mode"\*2, \*20

Sub-menu 1	Sub-menu 2	Settings	Code	Unit	
–	–	<Off> Eco	#725		15

- \*1 KX-TGF320 series: page 3
- \*2 If you program these settings using one of the units, you do not need to program the same item using another unit.
- \*3 This menu is not displayed when scrolling through the display menus. It is only available in direct command code.
- \*4 This feature allows the unit to automatically adjust the date and time each time caller information including date and time is received.  
To turn this feature on, select "Caller ID". To turn this feature off, select "Manual". (Caller ID subscribers only)  
To use this feature, set the date and time first (page 14).
- \*5 Base unit for KX-TGF310 series: this menu icon is displayed when repeater mode is set to "On".
- \*6 The preset melodies in this product ("Ringtone 3" - "Ringtone 40") are used with permission of © 2012 Copyrights Vision Inc.
- \*7 If you do not want the unit to ring before the caller information is received, set to "off". (Caller ID subscribers only)  
You can only remove the first ring if the unit rings 2 times or more by default, which depends on your phone service provider.
- \*8 This setting is available when you have the key finder (KX-TGA20EX). Read the installation manual for more information on the key finder.
- \*9 For models with supplied key finders, the display shows "1:Finder1".
- \*10 If you register 2 or more key finders.
- \*11 This menu is not displayed when repeater mode is set to "On".
- \*12 If you subscribe to a Caller ID service and want to view the caller's information after lifting up the handset to answer a call, turn off this feature.
- \*13 The recall/flash time depends on your telephone exchange or host PBX. Contact your PBX supplier if necessary.
- \*14 To prevent other users from joining your conversations with outside callers, turn this feature on.
- \*15 Handset only
- \*16 Handset for KX-TGF320 series: This menu icon is displayed when the key finder is not registered.
- \*17 Base unit only
- \*18 Handset for KX-TGF310 series: this menu icon is displayed when the key finder is not registered.
- \*19 Base unit for KX-TGF310 series: page 3



\*20 Base unit for KX-TGF310 series: this menu icon is displayed when repeater mode is set to "OFF".

## Alarm

An alarm sounds at the set time for 1 minute and is repeated 5 times at 5 minute intervals (snooze function). A text memo can also be displayed for the alarm. A total of 3 separate alarm times can be programmed for each handset. You can set one of 3 different alarm options (once, daily, or weekly) for each alarm time.

### Important:

- Make sure the unit's date and time setting is correct (page 14).

### Handset

- 1 **[☎]#720**
- 2 **[↕]**: Select the desired alarm. → **[OK]**
- 3 **[↕]**: Select the desired alarm option. → **[OK]**

<b>Off</b>
Turns alarm off. Go to step 9.
<b>Once</b>
An alarm sounds once at the set time.
<b>Daily</b>
An alarm sounds daily at the set time. Go to step 5.
<b>Weekly</b>
Alarm sounds weekly at the set time(s).

- 4 Proceed with the operation according to your selection in step 3.
  - **Once:**  
Enter the desired date and month. → **[OK]**
  - **Weekly:**  
**[↕]**: Select the desired day of the week and press **[✓]**. → **[OK]**
- 5 Set the desired time. → **[OK]**
- 6 Enter a text memo (10 characters max.). → **[OK]**
- 7 **[↕]**: Select the desired alarm tone. → **[OK]**
  - We recommend selecting a different ringer tone from the one used for outside calls.

- 8 **[↕]**: Select the desired snooze setting. → **[OK]**
- 9 **[OK]** → **[📞]**

### Note:

- The order in which you enter the date differs according to the selected display language.  
**Example:**  
Arabic/Persian: Month/Date  
English: Date/Month
- Press **[📞]** to stop the alarm completely.
- When the handset is in use, the alarm will not sound until the handset is in standby mode.
- Press any dial key or **[📞]** to stop the sound but keep the snooze function activated.
- If you want to make an outside call when the snooze function is activated, please stop the snooze function before making the call.

## Do not disturb mode

Do not disturb mode allows you to select a period of time during which the handset and/or base unit will not ring for outside calls. This feature is useful for time periods when you do not want to be disturbed, for example, while sleeping. Do not disturb mode can be set for each unit. Using the phonebook's category feature (page 23), you can also select categories of callers whose calls override do not disturb mode and ring the unit (Caller ID subscribers only).

### Important:

- Make sure the unit's date and time setting is correct (page 14).
- If you have set the alarm, the alarm sounds even if do not disturb mode is turned on.

### Turning do not disturb mode on/off

#### Handset / Base unit

- 1 **[☎]#238**
- 2 **[↕]**: Select the desired setting. → **[OK]**
  - If you select "OFF", press **[📞]** on the handset or **[↔]** on the base unit to exit.
- 3 Enter the desired hour and minute you wish to start this feature. → **[OK]**

## Programming

- 4 Enter the desired hour and minute you wish to end this feature. → [OK]
- 5 Proceed with the operation for your unit.  
**Handset:** [📞]  
**Base unit:** [↔]

### Changing the start and end time

#### Handset / Base unit

- 1 [☎]#237
- 2 Continue from step 3, "Turning do not disturb mode on/off", page 33.

### Setting the ring delay

This setting allows the handset and/or base unit to ring during do not disturb mode if the caller waits long enough. After the selected amount of time passes, the unit rings. If you select "No Ringing", the unit never rings during do not disturb mode.

#### Handset / Base unit

- 1 [☎]#239
- 2 [↕]: Select the desired setting. → [OK]
- 3 Proceed with the operation for your unit.  
**Handset:** [📞]  
**Base unit:** [↔]

#### Note:

- When the answering system answers the call, this feature does not work. (KX-TGF320 series: page 3)

### Selecting categories to bypass do not disturb mode

#### Handset / Base unit

- 1 [☎]#241
- 2 [↕]: Select the desired category. → [✓]
  - "✓" is displayed next to the selected category numbers.
  - To cancel the selected category: [↕]: Select the category. → Press [✓] again. "✓" disappears.
- 3 [OK]
- 4 Proceed with the operation for your unit.  
**Handset:** [📞]  
**Base unit:** [↔]

## Baby monitor

This feature allows you to listen in on a room where another handset is located, allowing you to easily monitor from different areas of the house or place. The monitored handset (placed in a baby's room, for example) will automatically call the monitoring handset, base unit, or the phone number stored when it detects sound.

#### Important:

- You should perform a test run of the baby monitor procedure to ensure that the baby monitor feature is set correctly. For example, test its sensitivity. Check the connection if you are diverting the baby monitor to an outside line.
- This feature should not be used as a substitute for a medical or caregiver's supervision. It is the caregiver's responsibility to stay close enough to handle any eventuality.

#### Note:

- If the unit is connected to a PBX system, you cannot set the baby monitor.
- During the monitoring mode, battery consumption is faster than usual. We recommend leaving the monitored handset on the charger.
- The monitored handset never rings while it is being monitored.  
If the base unit is placed near the monitored handset, turn off the base unit ringer volume (page 29).

## Setting the baby monitor

Perform the setting operation with the handset to be monitored (for example, the handset placed in a baby's room).

#### To monitor with a unit

The internal baby monitor feature is available:

- between handsets
- between a handset and the base unit

#### Handset

- 1 [☎]#268
- 2 [↕]: "On" → [OK]
- 3 [↕]: Select the desired unit's number to monitor with. → [OK]
  - "Baby Monitor" will be displayed.

- The registered unit's name/number is displayed.

**Note:**

- When this feature is on, another handset or base unit can hear the monitored handset by making an intercom call.

**To monitor from an outside line**

If you enable this feature, the unit will call a pre-programmed phone number when the handset detects sound. After you answer the call, you can listen in on the room where the handset is located.

■ **From the phonebook:**

- 1 [M] [#] [2] [6] [8]
- 2 [↕]: "On" → [OK]
- 3 [↕]: Select "External" to monitor from an outside line. → [OK] → [OK]
- 4 [↕]: "Phonebook" → [OK]
- 5 [↕]: Select the phonebook entry. → [OK]
  - "Baby Monitor" will be displayed.

**Note:**

- If you edit a phonebook entry which is assigned for monitoring, the edited entry does not transfer to the monitor.

■ **By entering phone numbers:**

- 1 [M] [#] [2] [6] [8]
- 2 [↕]: "On" → [OK]
- 3 [↕]: Select "External" to monitor from an outside line. → [OK] → [OK]
- 4 [↕]: "Manual" → [OK]
- 5 Enter the desired name. → [OK]
- 6 Enter the desired number. → [OK] 2 times
  - "Baby Monitor" will be displayed.

**Note:**

- The registered name/number is displayed.

**Turning off the baby monitor**

The monitored handset cannot be used while baby monitor is set to "On".

**Handset**

- 1 Press [M] on the handset being monitored.
- 2 [↕]: "On/Off" → [OK]
- 3 [↕]: "Off" → [OK] → [OK]

**Editing an outside monitoring number**

**Handset**

- 1 Press [M] on the handset being monitored.
- 2 [↕]: "On/Off" → [OK]
- 3 [↕]: "On" → [OK]
- 4 [↕]: Select the outside line. → [OK]
- 5 [M] → [↕]: "Edit" → [OK]
- 6 Edit the name if necessary. → [OK]
- 7 Edit the phone number if necessary. → [OK] 2 times

**Erasing an outside monitoring number**

**Handset**

- 1 Press [M] on the handset being monitored.
- 2 [↕]: "On/Off" → [OK]
- 3 [↕]: "On" → [OK]
- 4 [↕]: Select the outside line. → [OK]
- 5 [M] → [↕]: "Erase" → [OK]
- 6 [↕]: "Yes" → [OK] → [OK]

**Baby monitor sensitivity**

You can adjust the sensitivity of the baby monitor. Increase or decrease the sensitivity to adjust the sound level needed to trigger the baby monitor feature.

- This feature cannot be set during a monitoring call.

**Handset**

- 1 Press [M] on the handset being monitored.
- 2 [↕]: "Sensitivity Level" → [OK]
- 3 [↕]: Select the desired setting. → [OK] → [OK]

**Answering the baby monitor**

■ **When monitoring with a unit:**

**Handset:** Press [M] to answer a call.

**Base unit:** Press [M] to answer a call.

If you want to respond from the monitoring unit, press [M].

- The monitoring unit will answer calls automatically when the auto intercom feature is set to "On" (page 19).

## Programming

### Note:

- If you receive an outside call when communicating with the monitored handset, the interrupt tone sounds.
  - To answer the call with the handset, press **[📞]**, then press **[↶]**.
  - To answer the call with the base unit, press **[📞]** 3 times.\*1

\*1 If **[📞]** is pressed, press **[↶]** 2 times.

### ■ When monitoring from an outside line:

Answer the call.

If you want to respond from the monitoring phone, press **[#]1** using tone dialling.

You can turn off the baby monitor feature by pressing **[#]0**.

### Note:

- The unit disconnects the call automatically after 2 minutes.

## Other programming

### Changing the handset name

The default handset name is “Handset 1” to “Handset 6”. You can customise the name of each handset (“Bob”, “Kitchen”, etc.). This is useful when you make intercom calls between handsets. To display the handset name in standby mode, turn on the handset name display feature (page 36).

#### Handset

- 1 **[📞]#104**
- 2 Enter the desired name (10 characters max.).
- 3 **[OK] → [📞]**

### Displaying the handset name

You can select whether or not the handset name is displayed in standby mode. The default setting is “off”.

#### Handset

- 1 **[📞]#105**
- 2 **[↕]**: Select the desired setting. → **[OK] → [📞]**

### Storing an area code to be deleted automatically

In some situations, phone numbers stored automatically in the caller list (page 39) will include area codes. If you do not want to dial the area code when making calls from the caller list, you can store the area code which you want the unit to delete automatically.

**Example:** You have stored the area code “123”. If you make a call from the caller list to the phone number “123-456-7890”, the unit dials “456-7890”.

#### Handset / Base unit

- 1 **[📞]#255**
- 2 Enter an area code (5 digits max.). → **[OK] → [📞]**

### Call restriction

You can restrict selected units from dialling certain numbers. You can assign up to 6 phone numbers to be restricted, and select which units are to be restricted. Storing area codes here prevents the restricted units from dialling any phone number in that area code.









#### Handset / Base unit

- 1 **[📞]#256**
- 2 Enter the base unit PIN (default: “0000”).
  - If you forget your PIN, contact an authorised service centre.
- 3 **[↕]**: Select the desired units to be restricted. → **[✓]**
  - “✓” is displayed next to the selected numbers.
  - To cancel the selected unit: **[↕]**: Select the unit. → Press **[✓]** again. “✓” disappears.
- 4 **[OK]**
- 5 Select a memory location by pressing **1** to **6**. → **[OK]**
- 6 Enter the phone number or area code to be restricted (8 digits max.). → **[OK]**
- 7 Proceed with the operation for your unit.  
**Handset:** **[📞]**  
**Base unit:** **[↔]**

## Enhancing security for phone calls

You can increase the security of phone conversations by setting this feature to “Enhanced”. When “Enhanced” is selected,  is displayed. The default setting is “Normal”.

### Handset / Base unit

- 1     
- 2 : Select the desired setting. → [OK]
- 3 Proceed with the operation for your unit.  
Handset:   
Base unit: 

### Note:









- If you set repeater mode to “On” (page 38):
  - Security is set to “Normal” and  is displayed.
  - “Security” is not displayed in the display menu (page 30).
- When enhanced security is enabled, sound may cut in and out during conversations.

## Changing the base unit PIN

### Important:

- If you change the PIN (Personal Identification Number), please make note of your new PIN. The unit will not reveal the PIN to you. If you forget your PIN, contact an authorised service centre.

### Handset / Base unit

- 1     
- 2 Enter the current 4-digit base unit PIN (default: “0000”).
- 3 Enter the new 4-digit base unit PIN. → [OK]
- 4 : “Yes” → [OK]
- 5 Proceed with the operation for your unit.  
Handset:   
Base unit: 

## Registering a unit

### Operating additional units

Available for:  
KX-TGF310BX/KX-TGF320BX

## Additional handsets







Up to 6 handsets can be registered to the base unit.

### Important:

- The additional handset model recommended for use with this unit is noted on page 4. If another handset model is used, certain operations may not be available.

## Registering a handset to the base unit









The supplied handset and base unit are pre-registered. If for some reason the handset is not registered to the base unit (for example,  is displayed even when the handset is near the base unit), re-register the handset.

- 1 Handset:  
    
- 2 Base unit:  
Press and hold  for about 5 seconds.
  - If all registered handsets start ringing, press  again to stop, then repeat this step.
- 3 Handset:  
[OK] → Wait until “Base PIN” is displayed.  
→ Enter the base unit PIN (default: “0000”).  
→ [OK]
  - If you forget your PIN, contact an authorised service centre.

## Deregistering a handset

A handset can cancel its own registration to the base unit, or other handsets registered to the same base unit. This allows the handset to end its wireless connection with the system.

### Handset / Base unit

- 1     
  - All handsets registered to the base unit are displayed.
- 2 : Select the handset you want to cancel.  
→ [OK]
- 3 : “Yes” → [OK]
- 4 Proceed with the operation for your unit.  
Handset:   
Base unit: 

## Increasing the range of the base unit

You can increase the signal range of the base unit by using a DECT repeater. Please use only the

## Programming

---

Panasonic DECT repeater noted on page 4.  
Contact your Panasonic dealer for details.

### Important:

- Before registering the repeater to this base unit, you must turn the repeater mode on.
- Do not use more than one repeater at a time.

---

### Setting the repeater mode

#### Handset / Base unit

- 1 **[☎]#138**
- 2 **[↕]**: Select the desired setting. → **[OK]**
- 3 Proceed with the operation for your unit.  
**Handset:** **[☎]**  
**Base unit:** **[↔]**

---

### Registering the DECT repeater (KX-A405/ KX-A406) to the base unit

#### Note:

- Please use a repeater that has not yet been registered to another unit. If the repeater is registered to another unit, deregister it first, referring to the Installation Guide for the DECT repeater.

- 1 **Base unit:**  
Press and hold **[↔]** for about 5 seconds.
- 2 **DECT repeater:**  
Connect the AC adaptor, then wait until the **①** indicator and **☐** indicator light green.
- 3 **Base unit:**  
To exit the registration mode, press **[↔]**.

## Using Caller ID service

### Important:

- This unit is Caller ID compatible. To use Caller ID features, you must subscribe to a Caller ID service. Contact your phone service provider for details.

## Caller ID features

### Handset / Base unit

When an outside call is being received, the caller information is displayed.

Caller information for the last 50 callers is logged in the caller list from the most recent call to the oldest.

- If the unit cannot receive caller information, the following is displayed:
  - “**Out of Area**”: The caller dials from an area which does not provide a Caller ID service.
  - “**Private Caller**”: The caller requests not to send caller information.
- If the unit is connected to a PBX system, caller information may not be properly received. Contact your PBX supplier.

## Missed calls

### Handset / Base unit

If a call is not answered, the unit treats it as a missed call and **↔** is displayed. This lets you know if you should view the caller list to see who called while you were away.

Even if only one missed call in the caller list is viewed (page 39), **↔** disappears from the display. When you receive another new call, **↔** is displayed again.

### Note:

- Even when there are unviewed missed calls, **↔** disappears from the standby display if the following operation is performed by one of the units:
  - A handset is replaced on the charger.
  - Pressing **[Ⓜ]** on a handset.
  - Pressing **[↔]** on the base unit.

## Phonebook name display

When caller information is received and it matches a phone number stored in the phonebook, the

stored name in the phonebook is displayed and logged in the caller list.

## Caller list

### Important:

- Make sure the unit's date and time setting is correct (page 14).

## Viewing the caller list and calling back

### Handset / Base unit

- 1 **[→]**
- 2 Press **[▼]** to search from the most recent call, or press **[▲]** to search from the oldest call.
- 3 Proceed with the operation for your unit.
 

**Handset:**

  - To call back, press **[↶]**.
  - To exit, press **[Ⓜ]**.

**Base unit:**

  - To call back, lift the corded handset.
  - To exit, press **[↶]**.

### Note:

- If the entry has already been viewed or answered, “✓” is displayed.
- In step 1, you can also access the caller list as follows (KX-TGF310 series: page 3):
 

**Base unit:**

**[↶]** → **[↕]**: “Incoming Call” → **[OK]**
- If you do not want to dial the area code when making calls from the caller list, you can store the area code which you want the unit to delete automatically (page 36).

## Editing a caller's phone number

### Handset

- 1 **[→]**
- 2 **[↕]**: Select the desired entry. → **[Ⓜ]**
- 3 **[↕]**: “Edit & Call” → **[OK]**
- 4 Edit the number.
- 5 **[↶]**

### Base Unit

- 1 **[→]**
- 2 **[↕]**: Select the desired entry. → **[Ⓜ]**
- 3 Edit the number.

## Caller ID Service

---

- 4 Lift the corded handset.

### Erasing selected caller information

#### Handset / Base Unit

- 1 [→]
- 2 [↓]: Select the desired entry.
- 3 [X] → [↓]: “Yes” → [OK]
- 4 Proceed with the operation for your unit.

Handset: [⏏]

Base unit: [↔]

### Erasing all caller information

#### Handset / Base Unit

- 1 [→]
- 2 [X] → [↓]: “Yes” → [OK]
- 3 Proceed with the operation for your unit.

Handset: [⏏]

Base unit: [↔]



## Answering system

**Available for:**  
KX-TGF320 series (page 3)

The answering system can answer and record calls for you when you are unavailable to answer the phone.

You can also set the unit to play a greeting message but not to record caller messages by selecting “**Greeting Only**” as the recording time setting (page 47).

### Important:

- Make sure the unit’s date and time setting is correct (page 14).

## Memory capacity (including your greeting message)

The total recording capacity is about 40 minutes. A maximum of 64 messages can be recorded.

### Note:

- When message memory becomes full:
  - “**Messages Full**” is shown on the handset and base unit display.
  - The answer on/off indicator (📞) on the base unit flashes rapidly if the answering system is turned on.
  - 📞 and the total number of new messages are not displayed even if the answering system is turned on.
  - If you use the pre-recorded greeting message, the unit automatically switches to another pre-recorded greeting message asking callers to call again later.
  - If you recorded your own greeting message, the same message is still announced to callers even though their messages are not recorded.

## Turning the answering system on/off

The answering system is preset to on.

### Base unit

Press [📞] to turn on/off the answering system.

### Handset

- 1 **To turn on:**  
[📞]#327  
**To turn off:**  
[📞]#328
- 2 [📞]

### Note for base unit and handset:

- When the answering system is turned on:
  - the answer on/off indicator (📞) on the base unit lights up.
  - 📞 is displayed on the handset.

## Greeting message

When the unit answers a call, a greeting message is played to callers.

You can use either:

- your own greeting message
- a pre-recorded greeting message

## Recording your greeting message

You can configure this setting using either the base unit or one of the handsets.

### Handset / Base Unit

- 1 [📞]#302
- 2 [↕]: “Yes” → [OK]
- 3 After a beep sounds, speak clearly about 20 cm away from the microphone (2 minutes max.).
- 4 Press [■] to stop recording.
- 5 Proceed with the operation for your unit.  
**Handset:** [📞]  
**Base unit:** [↔]

## Using a pre-recorded greeting message

The unit provides 2 pre-recorded greeting messages:

- If you erase or do not record your own greeting message, the unit plays a pre-recorded greeting message asking callers to leave a message.
- If the message recording time (page 47) is set to “**Greeting Only**”, callers’ messages are not recorded and the unit plays a different pre-recorded greeting message asking callers to call again.

## Answering System

### Resetting to a pre-recorded greeting message

If you change into a pre-recorded greeting message once you record your own greeting message, your own recorded greeting message is erased.

You can configure this setting using either the base unit or one of the handsets.

#### Handset / Base Unit

- 1 [☎] # 3 0 4
- 2 [OK]
- 3 Proceed with the operation for your unit.  
Handset: [📞]  
Base unit: [↔]

### Playing back the greeting message

#### Handset / Base Unit

- 1 [☎] # 3 0 3
- 2 Proceed with the operation for your unit.  
Handset: [📞]  
Base unit: [↔]

## Listening to messages

### Important:

- If your phone service provider offers voicemail service, the voicemail service may answer calls before the base unit's built-in answering system has a chance to answer calls and record messages.

In this case, messages you expect to be recorded by the answering system will be recorded on the voicemail service. For more information, see "For landline voicemail service subscribers" (page 47).

- When using the base unit or handset to listen to messages, the noise reduction feature (page 18) is activated automatically in spite of the setting (NR is not displayed).

### Using the base unit

When new messages have been recorded:

- [▶■] on the base unit flashes.
- 09 is displayed on the base unit with the total number of new messages.

Press [▶■].

- During playback, [▶■] on the base unit lights.

- If new messages have been recorded, the base unit plays back new messages.
- If there are no new messages, the base unit plays back all messages.

### Operating the answering system during playback

Key	Operation
[▲] or [▼] OR [±] <sup>*1</sup>	Adjust the speaker volume
[⏮]	Repeat message <sup>*2</sup>
[⏭]	Skip message
[P]	Pause message To resume playback, press [▶■].
[▶■]	Stop playback
[X]	Erase currently playing message

\*1 Each press [±], speaker volume is increased by several levels.

\*2 If pressed within the first 5 seconds of a message, the previous message is played.

### Calling back (Caller ID subscribers only)

Lift the corded handset.

#### ■ Editing the number before calling back

- 1 Press [☎] during playback.
- 2 Edit the number.
- 3 Lift the corded handset.

### Rewinding the message

Press and hold [⏮] until the unit plays the desired part of the message.

- During rewinding, the base unit makes a continuous beeping sound. Rewinding speed may vary depending on the recorded message.
- At the beginning of the message, the unit plays the message at normal speed.

### Fast-forwarding the message

Press and hold [⏭] until the unit plays the desired part of the message.

- During fast-forwarding, the base unit makes a continuous beeping sound. Fast-forwarding speed may vary depending on the recorded message.

- Even if you press and hold [▶▶] when the end of this message is played, the next message is played at normal speed.

### Erasing all messages

Press [X] 2 times while the unit is not in use.

### Using the handset

When new messages have been recorded, [📞] is displayed on the handset with the total number of new messages.

#### 1 To listen to new messages:

[📞]#323

To listen to all messages:

[📞]#324

#### 2 When finished, press [📞].

#### Note:

- To switch to the receiver, press [↩].

### Operating the answering system

[📞] → [📞] → [OK]

Key	Operation
[▲] or [▼]	Adjust the receiver or speaker volume (during playback)
[1] or [◀]	Repeat message (during playback)*1
[2] or [▶]	Skip message (during playback)
[3]	Enter the "Settings" menu
[4]	Play new messages
[5]	Play all messages
[6]	Play greeting message
[7][6]	Record greeting message
[8]	Turn answering system on
[📞]	Pause message*2
[9] or [■]	Stop recording Stop playback
[0]	Turn answering system off
[X][4]*3	Erase currently playing message
[X][5]	Erase all messages
[X][6]	Reset to a pre-recorded greeting message

\*1 If pressed within the first 5 seconds of a message, the previous message is played.

\*2 To resume playback:

[↕]: "Play" → [OK]

\*3 You can also erase as follows:

[📞] → [↕]: "Erase" → [OK] → [↕]:  
"Yes" → [OK]

### Calling back (Caller ID subscribers only)

1 Press [📞] during playback.

2 [↕]: "Call Back" → [OK]

#### ■ Editing the number before calling back

1 Press [📞] during playback.

2 [↕]: "Edit & Call" → [OK]

3 Edit the number. → [↩]

### Erasing all messages

1 [📞]#325

2 [↕]: "Yes" → [OK] → [📞]

## Advanced new message alerting features

### Audible message alert

This feature allows the base unit to beep to inform you of a new message arrival when new messages are recorded. The base unit beeps 2 times every minute until you listen to the messages, if the "Base Unit Beep" setting is turned on. The default setting is "Off".

You can configure this setting using either the base unit or one of the handsets.

#### Handset / Base Unit

1 [📞]#339

2 [↕]: Select the desired setting. → [OK]

3 Proceed with the operation for your unit.

Handset: [📞]

Base unit: [↔]

### New message alert by a call

This feature allows you to receive a notification by phone when new messages are recorded. The base unit calls a phone number you specify. You can then operate the answering system remotely to listen to the new message.

To use this feature, you must:

## Answering System

- store a phone number to which the unit makes the call to.
  - turn on the new message alert setting.
- After you answer the new message alert call, you can listen to messages from that call (page 45). You can configure this setting using either the base unit or one of the handsets.

### Important:

- A new message alert is stopped 1 minute after the unit starts to call. The unit will not retry the call even if the call is not answered.

### Storing a phone number to which the unit makes an alert call

#### Handset

#### ■ From the phonebook:

- 1 [☐]#338
- 2 [↕]: “Notification to” → [OK] → [☐↔]
- 3 [↕]: “Phonebook” → [OK]
- 4 [↕]: Select the desired phonebook entry. → [OK] → [☐]

#### ■ By entering a phone number:

- 1 [☐]#338
- 2 [↕]: “Notification to” → [OK] → [☐↔]
- 3 [↕]: “Manual” → [OK]
- 4 Enter the desired name (16 characters max.). → [OK]
- 5 Enter the desired number (24 digits max.). → [OK] 2 times → [☐]

#### Base unit

#### ■ From the phonebook:

- 1 [☐]#338
- 2 [↕]: “Notification to” → [OK] → [☐]
- 3 [↕]: Select the desired phonebook entry. → [OK] → [↔]

#### ■ By entering a phone number:

- 1 [☐]#338
- 2 [↕]: “Notification to” → [OK] → [☐]

- 3 Enter the desired name (16 characters max.). → [OK]
- 4 Enter the desired number (24 digits max.). → [OK] 2 times → [↔]

### Turning on/off the new message alert setting

#### Handset / Base Unit

- 1 [☐]#338
- 2 [↕]: “On/Off” → [OK]
- 3 [↕]: Select the desired setting. → [OK]
- 4 Proceed with the operation for your unit.  
Handset: [☐]  
Base unit: [↔]

### Editing the set phone number

#### Handset

- 1 [☐]#338
- 2 [↕]: “Notification to” → [OK]
- 3 [☐] → [↕]: “Edit” → [OK]
- 4 Edit the name if necessary (16 characters max.). → [OK]
- 5 Edit the phone number if necessary (24 digits max.). → [OK] 2 times → [☐]

#### Base Unit

- 1 [☐]#338
- 2 [↕]: “Notification to” → [OK] → [☐]
- 3 Edit the name if necessary (16 characters max.). → [OK]
- 4 Edit the phone number if necessary (24 digits max.). → [OK] 2 times → [↔]

### Erasing the set phone number

#### Handset

- 1 [☐]#338
- 2 [↕]: “Notification to” → [OK]
- 3 [☐] → [↕]: “Erase” → [OK]
- 4 [↕]: “Yes” → [OK] → [☐]
  - The new message alert setting is turned off.

#### Base Unit

- 1 [☐]#338
- 2 [↕]: “Notification to” → [OK] → [X]
- 3 [↕]: “Yes” → [OK] → [↔]
  - The new message alert setting is turned off.

### Activating/inactivating the remote access code to play messages

If you activate this feature, you must enter the remote access code (page 45) to play the new message from the new message alert call. This is so that unauthorised parties cannot listen to your messages. The default setting is “Inactivate”.

- “Inactivate”: You can listen to the message by pressing **4** to play new messages (without entering the remote access code).
- “Activate”: You must enter your remote access code and then press **4** to play new message.

#### Handset / Base Unit

- 1 **[\*][\*][#][3][3][8]**
- 2 **[↕]**: “Remote Code” → **[OK]**
- 3 **[↕]**: Select the desired setting. → **[OK]**
- 4 Proceed with the operation for your unit.  
**Handset:** **[↻]**  
**Base unit:** **[↔]**

### Listening to messages

After you answer the new message alert, you can listen to the messages as follows.

#### ■ When the remote access code is set to “Inactivate”:

Press **4** to play the new message during the announcement.

#### ■ When the remote access code is set to “Activate”:

- 1 Enter the remote access code (page 45) during the announcement.
- 2 Press **4** to play the new message.

#### Note:

- Within 10 seconds after listening to new messages, you can press **[\*][9]** during the call to turn off the new message alert by a call feature.
- Even if the unit makes a new message alert call, the handset redial list does not show the record. However, on the base unit redial list it is shown as “Message Alert”.

## Remote operation

Using a touch-tone phone, you can call your phone number from outside and access the unit to listen to messages or change answering system settings. The unit’s voice guidance prompts you to press certain dial keys to perform different operations.

### Remote access code

A 3-digit remote access code must be entered when operating the answering system remotely. This code prevents unauthorised parties from listening to your messages remotely. You can configure this setting using either the base unit or one of the handsets.

#### Important:

- In order to operate the answering system remotely, you must first set a remote access code.

#### Handset / Base Unit

- 1 **[\*][\*][#][3][0][6]**
- 2 To turn on remote operation, enter the desired 3-digit remote access code.
- 3 **[OK]**
- 4 Proceed with the operation for your unit.  
**Handset:** **[↻]**  
**Base unit:** **[↔]**

### Deactivating remote operation

Press **[\*]** in step 2 on “Remote access code”, page 45.

- The entered remote access code is deleted.

## Using the answering system remotely

- 1 Dial your phone number from a touch-tone phone.
- 2 After the greeting message starts, enter your remote access code.
- 3 Follow the voice guidance prompts as necessary or control the unit using remote commands (page 46).
- 4 When finished, hang up.

## Answering System

### Voice guidance

During remote operation, the unit's voice guidance starts and prompts you to press [1] to perform a specific operation, or press [2] to listen to more available operations.

#### Note:

- If you do not press any dial keys within 10 seconds after a voice guidance prompt, the unit disconnects your call.

### Remote commands

You can press dial keys to access certain answering system functions without waiting for the voice guidance to prompt you.

Key	Operation
[1]	Repeat message (during playback)*1
[2]	Skip message (during playback)
[4]	Play new messages
[5]	Play all messages
[6]	Play greeting message
[7]	Record greeting message
[9]	Stop recording Stop playback
[0]	Turn answering system off
[*][4]	Erase currently playing message
[*][5]	Erase all messages
[*][6]	Reset to a pre-recorded greeting message (during greeting message playback)
[*][#]	End remote operation (or hang up)

\*1 If pressed within the first 5 seconds of a message, the previous message is played.

### Turning on the answering system remotely

- 1 Dial your phone number from a touch-tone phone.
- 2 Let the phone ring 15 times.
  - A long beep is heard.

- 3 Enter your remote access code within 10 seconds after the long beep.

- The greeting message is played back.
- You can either hang up, or enter your remote access code again and begin remote operation (page 45).

## Answering system settings

### Call screening

#### Handset / Base Unit

While a caller is leaving a message, you can listen to the call through the unit's speaker.

To adjust the speaker volume,

- press [▲] or [▼] repeatedly.
- press [±] on the base unit repeatedly.
- Each press [±], speaker volume is increased by several levels.

You can answer the call by:

- lifting the corded handset from the base unit, or
- pressing [↶] on the handset.

Call screening can be set for each unit. The default setting is "on".

1 [☒][#][3][1][0]

2 [↕]: Select the desired setting. → [OK]

3 Proceed with the operation for your unit.

Handset: [☒]

Base unit: [↶]

### Number of rings before the unit answers a call

You can change the number of times the phone rings "Number of Rings" before the unit answers a call. You can select 2 to 7 rings, or "Auto".

The default setting is "4 Rings".

"Auto": The unit's answering system answers at the end of the 2nd ring when new messages have been recorded, or at the end of the 5th ring when there are no new messages. If you call your phone from outside to listen to new messages (page 45), you know that there are no new messages when the phone rings for the 3rd time. You can then hang up without being charged for the call.

You can configure this setting using either the base unit or one of the handsets.

### Handset / Base Unit

- 1 [☎]#211
- 2 [↕]: Select the desired setting. → [OK]
- 3 Proceed with the operation for your unit.  
Handset: [☎]  
Base unit: [↔]

### For landline voicemail service subscribers

To receive voicemail and use answering system properly, please note the following:

- To use the voicemail service (page 48) provided by your phone service provider rather than the unit's answering system, turn off the answering system (page 41).
- To use this unit's answering system rather than the voicemail service provided by your phone service provider, please contact your phone service provider to deactivate your voicemail service.

If your phone service provider cannot do this:

- Set this unit's "Number of Rings" setting so that this unit's answering system answers calls before the voicemail service of your phone service provider does. It is necessary to check the number of rings required to activate the voicemail service provided by your phone service provider before changing this setting.
- Change the number of rings of the voicemail service so that the answering system can answer the call first. To do so, contact your phone service provider.

### Caller's recording time

You can change the maximum message recording time allowed for each caller. The default setting is "3 Minutes".

You can configure this setting using either the base unit or one of the handsets.

### Handset / Base Unit

- 1 [☎]#305
- 2 [↕]: Select the desired setting. → [OK]
- 3 Proceed with the operation for your unit.  
Handset: [☎]  
Base unit: [↔]

### Selecting "Greeting Only"

You can select "Greeting Only" which sets the unit to announce a greeting message to callers but not record messages.

Select "Greeting Only" in step 2 on "Caller's recording time", page 47.

#### Note:

- When you select "Greeting Only":
  - If you do not record your own message, the unit will play the pre-recorded greeting-only message asking callers to call again later.
  - If you use your own message, record the greeting-only message asking callers to call again later (page 41).

## Useful Information

### Voicemail service

Voicemail is an automatic answering service offered by your phone service provider. After you subscribe to this service, your phone service provider's voicemail system answers calls for you when you are unavailable to answer the phone or when your line is busy. Messages are recorded by your phone service provider, not your telephone. When you have new messages,  is displayed on the handset if message indication service is available. Please contact your phone service provider for details of this service.

#### Important:

- If  still remains on the display even after you have listened to new messages, turn it off by pressing and holding **[#]** for 2 seconds.
- To use the voicemail service provided by your phone service provider rather than the unit's answering system, turn off the answering system (page 41). For details, see page 47 (KX-TGF320 series: page 3).

### Wall mounting

The base unit can be mounted on a wall by changing the wall mounting adaptor's position.

#### Note:

- Make sure that the wall and the fixing method are strong enough to support the weight of the unit.
- Drive the screws (not supplied) into the wall.

#### Base unit

- 1 To remove the wall mounting adaptor, push down the release levers **(1)**. Remove the adaptor **(2)**.

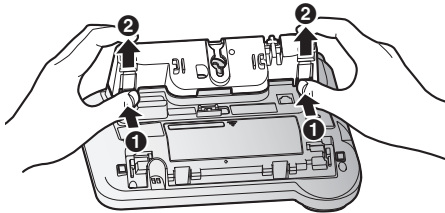

- 2
  - ① Turn the adaptor so that the words "UP WALL" are facing up.
  - ② Tuck the telephone line cord inside the wall mounting adaptor.
  - ③ Connect the AC adaptor cord and telephone line cord.

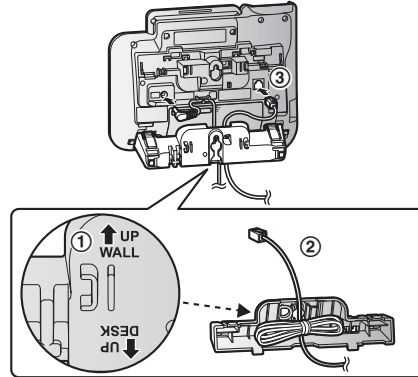

- 3 Insert the lower tabs of the adaptor into the unit's bottom slots **(1)**, then insert by pushing down the levers of the adaptor into the upper slots **(2)**.

- The words "UP WALL" should be facing up.

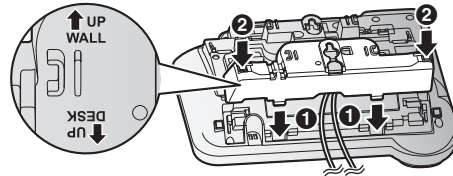

- 4 Mount the unit on a wall then slide down to secure in place.

- A** Screws
- B** 83 mm

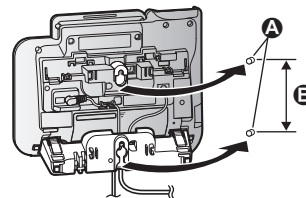



## Character entry

The dial keys are used to enter characters and numbers. Each dial key has multiple characters assigned to it. The characters that can be entered depend on the character entry mode (page 49).

- **Handset:** Press [◀] or [▶] to move the cursor left or right.
- **Base unit\*1:** Press [◀◀] or [▶▶] to move the cursor left or right.
- Press dial keys to enter characters and numbers.
- Press [C] to erase the character or number highlighted by the cursor. Press and hold [C] to erase all characters or numbers.
- Press [A→a] to switch between uppercase and lowercase.
- If you do not press any dial key within 2 seconds after entering a character, the character is fixed and the cursor moves to the next space.
- When entering another character located on the same dial key, operation will differ depending on the display language you select.

### English

- Press [▶] on the handset or [▶▶] on the base unit\*1 to move the cursor to the next space, then press the appropriate dial key.

### Arabic/Persian

- Press [◀] on the handset or [◀◀] on the base unit\*1 to move the cursor to the next space, then press the appropriate dial key.

\*1 Base unit navigator key is as follows.

Model No.	Left	Right
KX-TGF310	[◀]	[▶]
KX-TGF320	[◀◀]	[▶▶]

## Character entry modes

The available character entry modes are Alphabet (ABC), Numeric (0-9), Arabic/Persian (ا ب ت) and Extended (AÄÄ). When in these entry modes except Numeric, you can select which character is entered by pressing a dial key repeatedly.

### When the unit displays the character entry screen:

**Handset:** [ECO] → [↕]: Select a character entry mode. → [OK]

**Base unit:** [1/A/Ä] → [↕]: Select a character entry mode. → [OK]

### Note:

- ◻ in the following tables represents a single space.
- When you select Arabic or Persian as the display language, numbers in the character table are displayed in Arabic or Persian.

### Alphabet character table (ABC)

0	1	2	3	4	5	6	7	8	9	#
◻ 0	& ' ( ) * , - . / 1	A B C 2 a b c 2	D E F 3 d e f 3	G H I 4 g h i 4	J K L 5 j k l 5	M N O 6 m n o 6	P Q R S 7 p q r s 7	T U V 8 t u v 8	W X Y Z 9 w x y z 9	#

## Useful Information

### Numeric entry table (0-9)

0	1	2	3	4	5	6	7	8	9	#
0	1	2	3	4	5	6	7	8	9	#

### Arabic character table (ا ب ت)

- When you select Arabic as the display language, Arabic character table is available.

0	1	2	3	4	5	6	7	8	9	#
٠ ١	( ) ' & ٠ - ، * ١ /	ث ج ح ٢ خ ح	ا ب پة ٣ ا ا ا ا	ط ط ع ٤ غ ع	س ش ٥ ص ض ه	د ذ ر ز ٦	ي ي ع ٧ ئ	م ن ه و ٨ ف	ف ف ك ٩ ك گ ل	#

### Persian character table (ا ب ت)

- When you select Persian as the display language, Persian character table is available.

0	1	2	3	4	5	6	7	8	9	#
٠ ١	( ) ' & ٠ - ، * ١ /	ث ج ح ٢ خ ح	ا ب پة ٣ ا ا ا ا	ط ط ع ٤ غ ع	س ش ٥ ص ض ه	د ذ ر ز ٦	ي ي ع ٧ ئ	م ن ه و ٨ ف	ف ف ك ٩ ك گ ل	#

### Extended character table (AÄÄ)

0	1	2	3	4	5	6	7	8	9	#
٠ ١	& ' ( ) * , - . / 1	A À Á Â Ã Ä Å Æ B C Ç 2	D E È É Ê Ë Ë F 3	G Ğ H I Ì Í Î Ï 4	J K L 5	M N Ñ O Ò Ó Ô Õ Ö ø 6	P Q R S Ş ß 7	T U Ù Ú Û Ü Û V 8	W Ŵ X Y Ŷ Z 9	#
		a à á â ã ä å æ b c ç 2	d e è é ê ë ë f 3	g ğ h i ì í î ï 4	j k l 5	m n ñ o ò ó ô õ ö ø 6	p q r s ş ß 7	t u ù ú û ü Û v 8	w Ŵ x y Ŷ z 9	

- The following are used for both uppercase and lowercase: ø Ŵ Ŷ

## Error messages

Display message	Cause/solution
Base no power or No link. Reconnect AC adaptor.	<ul style="list-style-type: none"> <li>Confirm the base unit's AC adaptor is connected to the unit and the power outlet correctly.</li> <li>The handset has lost communication with the base unit. Move closer to the base unit and try again.</li> <li>Unplug the base unit's AC adaptor to reset the unit. Reconnect the adaptor and try again.</li> <li>The handset's registration may have been cancelled. Re-register the handset (page 37).</li> </ul>
Check Phone Line	<ul style="list-style-type: none"> <li>The supplied telephone line cord has not been connected yet or not connected properly. Check the connections (page 8).</li> </ul>
Error	<ul style="list-style-type: none"> <li>Recording was too short. Try again.</li> </ul>
Memory Full	<ul style="list-style-type: none"> <li>The phonebook memory is full. Erase unwanted entries (page 24).</li> <li>The call block list memory is full. Erase unwanted entries (page 22).</li> </ul>
Use rechargeable battery.	<ul style="list-style-type: none"> <li>A wrong type of battery such as alkaline or manganese was inserted. Use only the rechargeable Ni-MH batteries noted on page 4, 6.</li> </ul>
You must first subscribe to Caller ID.	<ul style="list-style-type: none"> <li>You must subscribe to a Caller ID service. Once you receive caller information after subscribing to a Caller ID service, this message will not be displayed.</li> </ul>

## Troubleshooting

If you still have difficulties after following the instructions in this section, disconnect the base unit's AC adaptor, then reconnect the base unit's AC adaptor. Remove the batteries from the handset, and then insert them into the handset again.

If the base unit batteries for power backup are installed, remove the batteries from the base unit, and then insert them into the base unit again.

### General use

Problem	Cause/solution
The handset does not turn on even after installing charged batteries.	<ul style="list-style-type: none"> <li>Place the handset on the charger to turn on the handset.</li> </ul>
The unit does not work.	<ul style="list-style-type: none"> <li>Make sure the batteries are installed correctly (page 8).</li> <li>Fully charge the batteries (page 9).</li> <li>Check the connections (page 8).</li> <li>Unplug the base unit's AC adaptor and remove the batteries from the handset to reset the unit. Reconnect the adaptor, insert the batteries into the handset and try again.</li> <li>The handset has not been registered to the base unit. Register the handset (page 37).</li> </ul>
The handset display is blank.	<ul style="list-style-type: none"> <li>The handset is not turned on. Turn the power on (page 14).</li> </ul>

## Useful Information



Problem	Cause/solution
I cannot hear a dial tone.	<ul style="list-style-type: none"> <li>● Make sure that you are using the supplied telephone line cord. Your old telephone line cord may have a different wiring configuration.</li> <li>● The base unit's AC adaptor or telephone line cord is not connected. Check the connections.</li> <li>● Disconnect the base unit from the telephone line and connect the line to a known working telephone. If the working telephone operates properly, contact our service personnel to have the unit repaired. If the working telephone does not operate properly, contact your phone service provider.</li> </ul>
The base unit beeps.	<ul style="list-style-type: none"> <li>● New messages have been recorded. Listen to the new messages (page 42).</li> </ul>
The unit does not work during a power failure.	<ul style="list-style-type: none"> <li>● You can insert 2 AAA (R03) batteries (not supplied) into the base unit that will power the unit temporarily in the event of a power failure (page 9).</li> <li>● The base unit display is blank if the saving mode is "On" (page 10).</li> </ul>

## Menu list

Problem	Cause/solution
The display is in a language I cannot read.	<ul style="list-style-type: none"> <li>● Change the display language (page 14).</li> </ul>
I cannot activate the eco mode.	<ul style="list-style-type: none"> <li>● You cannot set eco mode when you set the repeater mode "On". If required, set the repeater mode to "Off" (page 38).</li> </ul>
I cannot register a handset to a base unit.	<ul style="list-style-type: none"> <li>● The maximum number of handsets (6) is already registered to the base unit. Cancel unused handset registrations from the base unit (page 37).<sup>*1</sup></li> <li>● You entered the wrong PIN. If you forget your PIN, contact an authorised service centre.</li> </ul>

\*1 KX-TGF310BX/KX-TGF320BX

## Battery recharge

Problem	Cause/solution
The handset beeps and/or  flashes.	<ul style="list-style-type: none"> <li>● Battery charge is low. Fully charge the batteries (page 9).</li> </ul>
I fully charged the batteries, but –  still flashes or – the operating time seems to be shorter.	<ul style="list-style-type: none"> <li>● Clean the battery ends (<math>\oplus</math>, <math>\ominus</math>) and the charge contacts with a dry cloth and charge again.</li> <li>● It is time to replace the batteries (page 8).</li> </ul>

## Useful Information

### Making/answering calls, intercom

Problem	Cause/solution
📵 is displayed.	<ul style="list-style-type: none"> <li>• The handset is too far from the base unit. Move closer.</li> <li>• The base unit's AC adaptor is not properly connected. Reconnect AC adaptor to the base unit.</li> <li>• The handset is not registered to the base unit. Register it (page 37).</li> <li>• Activating eco mode reduces the range of the base unit in standby mode. If required, turn eco mode off (page 15).</li> </ul>
Noise is heard, sound cuts in and out.	<ul style="list-style-type: none"> <li>• You are using the handset or base unit in an area with high electrical interference. Re-position the base unit and use the handset away from sources of interference.</li> <li>• Move closer to the base unit.</li> <li>• If you use a DSL/ADSL service, we recommend connecting a DSL/ADSL filter between the base unit and the telephone line jack. Contact your DSL/ADSL provider for details.</li> </ul>
Sound quality seems to be getting worse.	<ul style="list-style-type: none"> <li>• You have registered a handset that is not recommended (page 4). The clearest sound quality is only possible by registering the recommended handset.</li> </ul>
The unit does not ring.	<ul style="list-style-type: none"> <li>• The ringer volume is turned off. Adjust ringer volume (page 17, 29).</li> <li>• Do not disturb mode is turned on. Turn it off (page 33).</li> </ul>
I cannot make a call.	<ul style="list-style-type: none"> <li>• The dialling mode may be set incorrectly. Change the setting (page 15).</li> <li>• You dialled a call restricted number (page 36).</li> <li>• The key lock feature is turned on. Turn it off (page 20).</li> </ul>

### Caller ID

Problem	Cause/solution
Caller information is not displayed.	<ul style="list-style-type: none"> <li>• You must subscribe to a Caller ID service. Contact your phone service provider for details.</li> <li>• If your unit is connected to any additional telephone equipment, remove and plug the unit directly into the wall jack.</li> <li>• If you use a DSL/ADSL service, we recommend connecting a DSL/ADSL filter between the base unit and the telephone line jack. Contact your DSL/ADSL provider for details.</li> <li>• Other telephone equipment may be interfering with this unit. Disconnect the other equipment and try again.</li> </ul>
Caller information is slow to display.	<ul style="list-style-type: none"> <li>• Depending on your phone service provider, the unit may display the caller's information at the 2nd ring or later. Set the first ring to "OFF" (page 29).</li> <li>• Move closer to the base unit.</li> </ul>
Time on the unit has shifted.	<ul style="list-style-type: none"> <li>• Incorrect time information from incoming Caller ID changes the time. Set the time adjustment to "Manual" (off) (page 29).</li> </ul>
The name stored in the phonebook is not fully displayed while an outside call is being received.	<ul style="list-style-type: none"> <li>• Edit the phonebook entry name to fit in 1 line of text (page 24).</li> </ul>

## Useful Information

### Answering system

Problem	Cause/solution
The unit does not record new messages.	<ul style="list-style-type: none"><li>• The answering system is turned off. Turn it on (page 41).</li><li>• The message memory is full. Erase unwanted messages (page 42).</li><li>• The recording time is set to "Greeting Only". Change the setting (page 47).</li><li>• Your phone service provider's voicemail service may be answering your calls before the unit's answering system can answer your calls. Change the unit's number of rings setting (page 46) to a lower value, or contact your phone service provider.</li><li>• The answering system will not answer incoming calls while the other devices such as handsets are engaged in a call.</li></ul>
I cannot operate the answering system remotely.	<ul style="list-style-type: none"><li>• The remote access code is not set. Set the remote access code (page 45).</li><li>• You are entering the wrong remote access code. If you have forgotten your remote access code, enter the remote access code setting to check your current code (page 45).</li><li>• The answering system is turned off. Turn it on (page 46).</li></ul>
The unit does not emit the specified number of rings.	<ul style="list-style-type: none"><li>• If the first ring is turned off (page 29), the number of rings decreases by 1 from the specified number of rings.</li></ul>

### Liquid damage

Problem	Cause/solution
Liquid or other form of moisture has entered the handset/base unit.	<ul style="list-style-type: none"><li>• Disconnect the AC adaptor and telephone line cord from the base unit. Remove the batteries from the handset and leave to dry for at least 3 days. After the handset/base unit are completely dry, reconnect the AC adaptor and telephone line cord. Insert the batteries and charge fully before use. If the unit does not work properly, contact an authorised service centre.</li></ul>

#### Caution:

- To avoid permanent damage, do not use a microwave oven to speed up the drying process.

## Index

- A** Additional handsets: 37
  - Alarm: 33
  - Answering calls: 17
  - Answering system: 41
    - Call screening: 46
    - Erasing messages: 42, 43, 46
    - Greeting message: 41
    - Greeting only: 47
    - Listening to messages: 42, 43, 45
    - New message alerting: 43
    - Number of rings: 46
    - Recording time: 47
    - Remote access code: 45
    - Remote operation: 45
    - Turning on/off: 41
  - Area code: 36
  - Auto intercom: 19
  - Auto talk: 17, 30
- B** Baby monitor: 34
  - Battery: 8, 10
  - Battery saving mode: 10
- C** Call restriction: 36
  - Call share: 18
  - Call waiting: 18
  - Call Waiting Caller ID: 18
  - Caller ID service: 39
  - Caller list: 39
  - Caller list edit: 39
  - Category: 23
  - Chain dial: 24
  - Character entry: 49
  - Conference calls: 18
  - Control type: 11, 12, 13
- D** Date and time: 14
  - Dialling mode: 15
  - Direct command code: 27
  - Display
    - Contrast: 30
    - Language: 14
  - Do not disturb mode: 33
- E** Eco mode: 15
  - Equalizer: 18
  - Error messages: 51
- F** First ring: 29
- H** Handset
  - Deregistration: 37
  - Locator: 12
  - Name: 36
  - Registration: 37
  - Hold: 17
- I** Intercom: 19
- K** Key finder: 29, 31
  - Key lock: 20
  - Keytones: 30
- M** Making calls: 16
  - Missed calls: 39
  - Mute: 17
- N** Noise reduction: 18
  - Nuisance call block: 21
- O** One-touch dial buttons: 26
- P** Pause: 16
  - Phonebook: 23
  - PIN: 37
  - Power failure (power backup operation): 9
  - Power on/off: 14
  - Privacy mode: 30
- R** Recall/flash: 17
  - Redialling: 16
  - Repeater: 37
  - Ringer tone: 29
- S** Security for phone calls: 37
  - Speakerphone: 16
  - Speed dial: 24
- T** Temporary tone dialling: 18
  - Time adjustment: 29
  - Transferring calls: 18
  - Troubleshooting: 51
- V** Voicemail: 48
  - Volume
    - Receiver: 16
    - Ringer (Base unit): 17, 29
    - Ringer (Handset): 17, 29
    - Speaker: 16
- W** Wall mounting: 48

**For your future reference**

We recommend keeping a record of the following information to assist with any repair under warranty.

Serial No.	Date of purchase
(found on the bottom of the base unit)	
Name and address of dealer	

Attach your purchase receipt here.
------------------------------------

Panasonic System Networks Co., Ltd.

1-62, 4-chome, Minoshima, Hakata-ku, Fukuoka 812-8531, Japan

Web Site: <http://www.panasonic.com>

© Panasonic System Networks Co., Ltd. 2015



\*PNQX6801ZA\*

**PNQX6801ZA** TT0815YM0 (E)